

VIPA System MICRO

CPU | M13-CCF0000 | Manual

HB400 | CPU | M13-CCF0000 | en | 18-50

SPEED7 CPU M13C



VIPA GmbH
Ohmstr. 4
91074 Herzogenaurach
Telephone: 09132-744-0
Fax: 09132-744-1864
Email: info@vipa.com
Internet: www.vipa.com

Table of contents

1	General	8
	1.1 Copyright © VIPA GmbH	8
	1.2 About this manual.....	9
	1.3 Safety information.....	10
2	Basics and mounting	11
	2.1 Safety information for users.....	11
	2.2 System conception.....	12
	2.3 Dimensions.....	13
	2.4 Mounting.....	14
	2.4.1 Mounting CPU.....	14
	2.4.2 Mounting the extension module.....	17
	2.4.3 Mounting periphery module.....	18
	2.5 Wiring.....	19
	2.5.1 Wiring CPU.....	19
	2.5.2 Wiring periphery module.....	23
	2.6 Demounting.....	25
	2.6.1 Demounting CPU.....	25
	2.6.2 Demounting the extension module.....	29
	2.6.3 Demounting periphery module.....	30
	2.7 Installation guidelines.....	33
	2.8 General data.....	35
3	Hardware description	37
	3.1 Properties.....	37
	3.2 Structure.....	38
	3.2.1 System MICRO CPU M13C.....	38
	3.2.2 Interfaces.....	39
	3.2.3 LEDs.....	43
	3.2.4 Memory management.....	47
	3.2.5 Slot for storage media.....	47
	3.2.6 Buffering mechanisms.....	48
	3.2.7 Operating mode switch.....	48
	3.3 Option: Extension module EM M09 2x serial interface	49
	3.4 Technical data.....	51
	3.4.1 Technical data CPU.....	51
	3.4.2 Technical data EM M09.....	64
4	Deployment CPU M13-CCF0000	65
	4.1 Assembly.....	65
	4.2 Start-up behavior.....	65
	4.3 Addressing.....	66
	4.3.1 Overview.....	66
	4.3.2 Default address assignment of the I/O part.....	66
	4.3.3 Option: Addressing periphery modules.....	67
	4.4 Hardware configuration - CPU.....	68
	4.5 Hardware configuration - System MICRO modules.....	70
	4.6 Hardware configuration - Ethernet PG/OP channel.....	71
	4.6.1 <i>Take IP address parameters in project</i>	72
	4.7 Setting standard CPU parameters.....	76

4.7.1	Parameterization via Siemens CPU.....	76
4.7.2	Parameter CPU.....	77
4.8	Setting VIPA specific CPU parameters.....	80
4.9	Project transfer.....	81
4.9.1	Transfer via Ethernet.....	81
4.9.2	Transfer via memory card.....	82
4.9.3	Option: Transfer via MPI.....	82
4.10	Accessing the web server.....	85
4.10.1	Device web page.....	85
4.10.2	<i>WebVisu</i> project.....	89
4.11	Operating modes.....	91
4.11.1	Overview.....	91
4.11.2	Function security.....	93
4.12	Overall reset.....	94
4.12.1	Overall reset by means of the operating mode switch.....	94
4.12.2	Overall reset by means of the Siemens SIMATIC Manager	94
4.12.3	Actions after the overall reset.....	94
4.13	Firmware update.....	96
4.14	Reset to factory settings.....	97
4.15	Deployment storage media - VSD, VSC.....	98
4.16	Extended know-how protection.....	101
4.17	CMD - auto commands.....	102
4.18	Control and monitoring of variables with test functions.....	104
4.19	Diagnostic entries.....	105
5	Deployment I/O periphery.....	106
5.1	Overview.....	106
5.2	Address assignment.....	107
5.3	Analog input.....	108
5.3.1	Properties.....	108
5.3.2	Analog value representation.....	108
5.3.3	Wiring.....	109
5.3.4	Parametrization.....	110
5.4	Digital input.....	111
5.4.1	Properties.....	111
5.4.2	Wiring.....	111
5.4.3	Parametrization.....	112
5.4.4	Status indication.....	113
5.5	Digital output.....	115
5.5.1	Properties.....	115
5.5.2	Wiring.....	115
5.5.3	Parametrization.....	116
5.5.4	Status indication.....	116
5.6	Counting.....	118
5.6.1	Properties.....	118
5.6.2	Wiring.....	118
5.6.3	Proceeding.....	120
5.6.4	Parametrization.....	121
5.6.5	Counter operating modes.....	126
5.6.6	Counter - Additional functions.....	133

5.6.7	Diagnostics and interrupt.....	139
5.7	Frequency measurement.....	140
5.7.1	Properties.....	140
5.7.2	Wiring.....	141
5.7.3	Proceeding.....	142
5.7.4	Parametrization.....	142
5.7.5	Status indication.....	144
5.8	Pulse width modulation - PWM.....	146
5.8.1	Properties.....	146
5.8.2	Wiring.....	146
5.8.3	Proceeding.....	147
5.8.4	Parametrization.....	147
5.8.5	Status indication.....	149
5.9	Pulse train.....	151
5.9.1	Properties.....	151
5.9.2	Wiring.....	152
5.9.3	Proceeding.....	152
5.9.4	Parametrization.....	153
5.9.5	Status indication.....	154
5.10	Diagnostic and interrupt.....	155
5.10.1	Overview.....	155
5.10.2	Process interrupt.....	155
5.10.3	Diagnostic interrupt.....	157
6	Deployment PG/OP communication - productive.....	163
6.1	Basics - Industrial Ethernet in automation.....	163
6.2	Basics - ISO/OSI reference model.....	164
6.3	Basics - Terms.....	166
6.4	Basics - Protocols.....	167
6.5	Basics - IP address and subnet.....	168
6.6	Fast introduction.....	170
6.7	Hardware configuration.....	170
6.8	Configure Siemens S7 connections.....	171
6.9	Configure Open Communication.....	176
7	Deployment PG/OP communication - PROFINET.....	179
7.1	Basics PROFINET.....	179
7.2	PROFINET installation guidelines.....	181
7.3	Deployment as PROFINET IO controller.....	182
7.3.1	Steps of configuration.....	182
7.3.2	Commissioning and initialization.....	183
7.3.3	Configuration PROFINET IO controller.....	183
7.3.4	Configuration PROFINET IO device.....	185
7.4	Deployment as PROFINET I-Device.....	186
7.4.1	Steps of configuration.....	186
7.4.2	Installing the GSDML file.....	187
7.4.3	Configuration as I-Device.....	188
7.4.4	Configuration in the higher-level IO controller.....	189
7.4.5	Error behavior and interrupts.....	190
7.5	MRP.....	193
7.6	Topology.....	194

7.7	Device replacement without exchangeable medium/PG.....	195
7.8	Commissioning and start-up behavior.....	196
7.9	PROFINET diagnostics.....	197
7.9.1	Overview.....	197
7.9.2	Diagnostics with the configuration and engineering tool.....	197
7.9.3	Diagnostics during runtime in the user program.....	197
7.9.4	Diagnostics via OB start information.....	199
7.9.5	Diagnostics status indication via SSLs.....	199
7.10	PROFINET system limits.....	201
8	Option: PtP communication.....	202
8.1	Fast introduction.....	202
8.2	Principle of the data transfer.....	203
8.3	PtP communication via extension module EM M09.....	204
8.4	Parametrization.....	207
8.4.1	FC/SFC 216 - SER_CFG - Parametrization PtP.....	207
8.5	Communication.....	208
8.5.1	FC/SFC 217 - SER_SND - Send to PtP.....	208
8.5.2	FC/SFC 218 - SER_RCV - Receive from PtP.....	208
8.6	Protocols and procedures.....	208
8.7	Modbus - Function codes	212
9	Option: Deployment PROFIBUS communication.....	216
9.1	Fast introduction.....	216
9.2	PROFIBUS communication.....	217
9.3	PROFIBUS communication via extension module EM M09.....	218
9.4	Deployment as PROFIBUS DP slave.....	220
9.5	PROFIBUS installation guidelines.....	222
10	Configuration with VIPA SPEED7 Studio.....	225
10.1	SPEED7 Studio - Overview.....	225
10.2	SPEED7 Studio - Work environment.....	226
10.2.1	Project tree	228
10.2.2	Catalog	229
10.3	SPEED7 Studio - Hardware configuration - CPU.....	231
10.4	SPEED7 Studio - Hardware configuration - Ethernet PG/OP channel.....	232
10.5	SPEED7 Studio - Hardware configuration - I/O modules.....	234
10.6	Deployment I/O periphery.....	235
10.6.1	Overview.....	235
10.6.2	Analog input.....	235
10.6.3	Digital input.....	237
10.6.4	Digital output.....	237
10.6.5	Counter.....	238
10.6.6	Frequency measurement.....	242
10.6.7	Pulse width modulation - PWM.....	244
10.6.8	Pulse train.....	246
10.7	Deployment Web visualization.....	248
10.7.1	Activate WebVisu functionality.....	249
10.7.2	WebVisu editor.....	249
10.7.3	Start-up of the WebVisu project.....	252
10.7.4	Access to the WebVisu.....	253
10.7.5	Status of the WebVisu.....	253

10.8	<i>SPEED7 Studio</i> - Project transfer.....	254
10.8.1	Transfer via MPI.....	254
10.8.2	Transfer via Ethernet.....	256
10.8.3	Transfer via memory card.....	257
11	Configuration with TIA Portal.....	258
11.1	TIA Portal - Work environment	258
11.1.1	General.....	258
11.1.2	Work environment of the TIA Portal.....	259
11.2	TIA Portal - Hardware configuration - CPU.....	259
11.3	TIA Portal - Hardware configuration - Ethernet PG/OP channel.....	263
11.3.1	<i>Take IP address parameters in project</i>	264
11.4	TIA Portal - VIPA-Include library.....	268
11.5	TIA Portal - Project transfer.....	269
11.5.1	Transfer via Ethernet.....	269
11.5.2	Transfer via memory card.....	269
11.5.3	Option: Transfer via MPI.....	270
	Appendix.....	272
A	System specific event IDs.....	274
B	Integrated blocks.....	322
C	SSL partial list.....	325

1 General

1.1 Copyright © VIPA GmbH

All Rights Reserved

This document contains proprietary information of VIPA and is not to be disclosed or used except in accordance with applicable agreements.

This material is protected by the copyright laws. It may not be reproduced, distributed, or altered in any fashion by any entity (either internal or external to VIPA), except in accordance with applicable agreements, contracts or licensing, without the express written consent of VIPA and the business management owner of the material.

For permission to reproduce or distribute, please contact: VIPA, Gesellschaft für Visualisierung und Prozessautomatisierung mbH Ohmstraße 4, D-91074 Herzogenaurach, Germany

Tel.: +49 9132 744 -0

Fax.: +49 9132 744-1864

E-Mail: info@vipa.de

<http://www.vipa.com>



Every effort has been made to ensure that the information contained in this document was complete and accurate at the time of publishing. Nevertheless, the authors retain the right to modify the information.

This customer document describes all the hardware units and functions known at the present time. Descriptions may be included for units which are not present at the customer site. The exact scope of delivery is described in the respective purchase contract.

CE Conformity Declaration

Hereby, VIPA GmbH declares that the products and systems are in compliance with the essential requirements and other relevant provisions. Conformity is indicated by the CE marking affixed to the product.

Conformity Information

For more information regarding CE marking and Declaration of Conformity (DoC), please contact your local VIPA customer service organization.

Trademarks

VIPA, SLIO, System 100V, System 200V, System 300V, System 300S, System 400V, System 500S and Commander Compact are registered trademarks of VIPA Gesellschaft für Visualisierung und Prozessautomatisierung mbH.

SPEED7 is a registered trademark of profichip GmbH.

SIMATIC, STEP, SINEC, TIA Portal, S7-300, S7-400 and S7-1500 are registered trademarks of Siemens AG.

Microsoft and Windows are registered trademarks of Microsoft Inc., USA.

Portable Document Format (PDF) and Postscript are registered trademarks of Adobe Systems, Inc.

All other trademarks, logos and service or product marks specified herein are owned by their respective companies.

Information product support

Contact your local VIPA Customer Service Organization representative if you wish to report errors or questions regarding the contents of this document. If you are unable to locate a customer service centre, contact VIPA as follows:

VIPA GmbH, Ohmstraße 4, 91074 Herzogenaurach, Germany

Telefax: +49 9132 744-1204

E-Mail: documentation@vipa.de

Technical support

Contact your local VIPA Customer Service Organization representative if you encounter problems with the product or have questions regarding the product. If you are unable to locate a customer service centre, contact VIPA as follows:

VIPA GmbH, Ohmstraße 4, 91074 Herzogenaurach, Germany

Tel.: +49 9132 744-1150 (Hotline)

E-Mail: support@vipa.de

1.2 About this manual

Objective and contents

This manual describes the CPU M13-CCF0000 of the System MICRO from VIPA. It contains a description of the construction, project implementation and usage.

Product	Order number	as of state:	
		CPU-HW	CPU-FW
CPU M13C	M13-CCF0000	01	V2.4.12

Target audience

The manual is targeted at users who have a background in automation technology.

Structure of the manual

The manual consists of chapters. Every chapter provides a self-contained description of a specific topic.

Guide to the document

The following guides are available in the manual:

- An overall table of contents at the beginning of the manual
- References with page numbers

Availability

The manual is available in:

- printed form, on paper
- in electronic form as PDF-file (Adobe Acrobat Reader)

Icons Headings

Important passages in the text are highlighted by following icons and headings:

**DANGER!**

Immediate or likely danger. Personal injury is possible.

**CAUTION!**

Damages to property is likely if these warnings are not heeded.



Supplementary information and useful tips.

1.3 Safety information

Applications conforming with specifications

The system is constructed and produced for:

- communication and process control
- general control and automation tasks
- industrial applications
- operation within the environmental conditions specified in the technical data
- installation into a cubicle

**DANGER!**

This device is not certified for applications in

- in explosive environments (EX-zone)

Documentation

The manual must be available to all personnel in the

- project design department
- installation department
- commissioning
- operation

**CAUTION!**

The following conditions must be met before using or commissioning the components described in this manual:

- Hardware modifications to the process control system should only be carried out when the system has been disconnected from power!
- Installation and hardware modifications only by properly trained personnel.
- The national rules and regulations of the respective country must be satisfied (installation, safety, EMC ...)

Disposal

National rules and regulations apply to the disposal of the unit!

2 Basics and mounting

2.1 Safety information for users

Handling of electrostatic sensitive modules

VIPA modules make use of highly integrated components in MOS-Technology. These components are extremely sensitive to over-voltages that can occur during electrostatic discharges. The following symbol is attached to modules that can be destroyed by electrostatic discharges.



The Symbol is located on the module, the module rack or on packing material and it indicates the presence of electrostatic sensitive equipment. It is possible that electrostatic sensitive equipment is destroyed by energies and voltages that are far less than the human threshold of perception. These voltages can occur where persons do not discharge themselves before handling electrostatic sensitive modules and they can damage components thereby, causing the module to become inoperable or unusable. Modules that have been damaged by electrostatic discharges can fail after a temperature change, mechanical shock or changes in the electrical load. Only the consequent implementation of protection devices and meticulous attention to the applicable rules and regulations for handling the respective equipment can prevent failures of electrostatic sensitive modules.

Shipping of modules

Modules must be shipped in the original packing material.

Measurements and alterations on electrostatic sensitive modules

When you are conducting measurements on electrostatic sensitive modules you should take the following precautions:

- Floating instruments must be discharged before use.
- Instruments must be grounded.

Modifying electrostatic sensitive modules you should only use soldering irons with grounded tips.



CAUTION!

Personnel and instruments should be grounded when working on electrostatic sensitive modules.

2.2 System conception

Overview

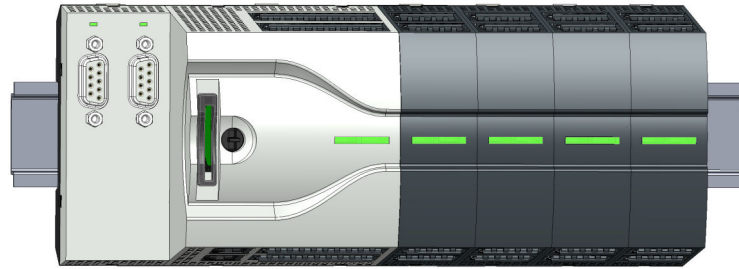

The System MICRO is a modular automation system for assembly on a 35mm mounting rail. By means of periphery modules this system may be adapted matching to your automation tasks. In addition, it is possible to expand your CPU by appropriate interfaces. The wiring complexity is low, because the DC 24V electronic section supply is integrated to the backplane bus and this allows replacement with standing wire.

Components

- CPU
- Extension module
- Periphery module

CPU

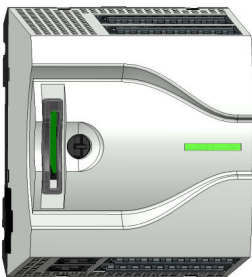

With the CPU electronic, input/output components and power supply are integrated to one casing. In addition, up to 8 periphery modules of the System MICRO can be connected to the backplane bus. As head module via the integrated power module for power supply CPU electronic and the I/O components are supplied as well as the electronic of the periphery modules, which are connected via backplane bus. To connect the power supply of the I/O components and for DC 24V electronic power supply of the periphery modules, which are connected via backplane bus, the CPU has removable connectors. By installing of up to 8 periphery modules at the backplane bus of the CPU, these are electrically connected, this means these are assigned to the backplane bus and connected to the DC 24V electronic power supply.

Extension module



By using extension modules you can extend the interfaces of the CPU. The attachment to the CPU is made by plugging on the left side of the CPU. You can only connect one extension module to the CPU at a time.

Periphery module



By means of up to 8 periphery modules, you can extend the internal I/O areas. The attachment to the CPU is made by plugging them on the right side of the CPU.

2.3 Dimensions

Dimensions CPU M13C

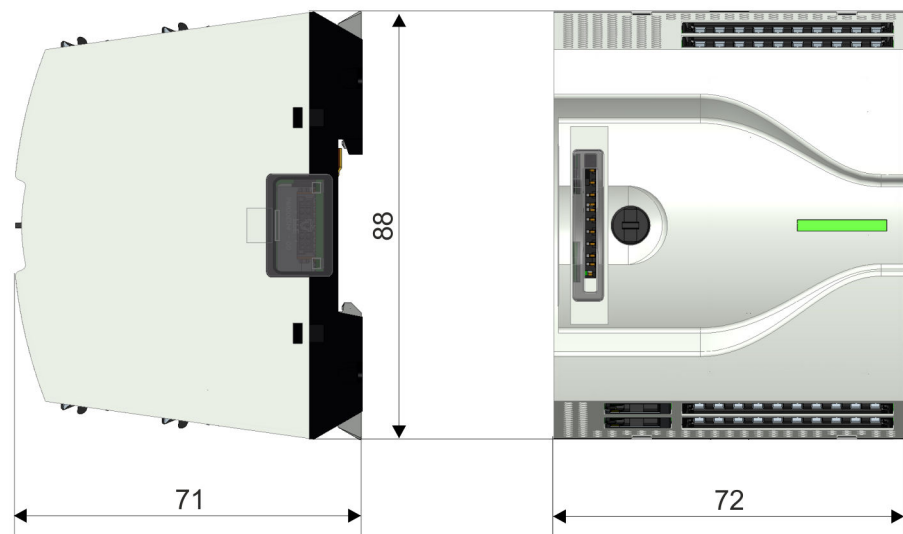

Dimensions in mm

Dimensions extension module EM M09

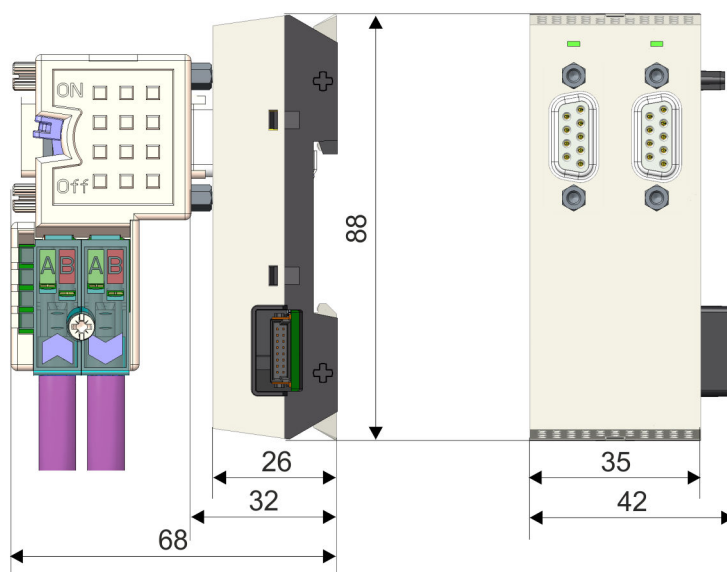

Dimensions in mm

Dimensions periphery module

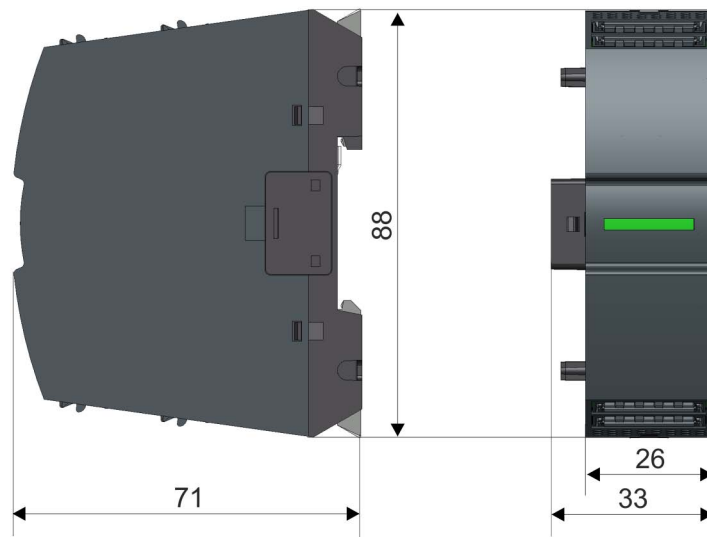

Dimensions in mm

2.4 Mounting

2.4.1 Mounting CPU

2.4.1.1 Mounting CPU without mounting rail



CAUTION!

Mounting without mounting rail is only permitted, if you only want to use the CPU without extension and periphery modules. Otherwise, a mounting rail must always be used for EMC technical reasons.

Proceeding

You can screw the CPU to the back wall by means of screws via the locking levers. This happens with the following proceeding:

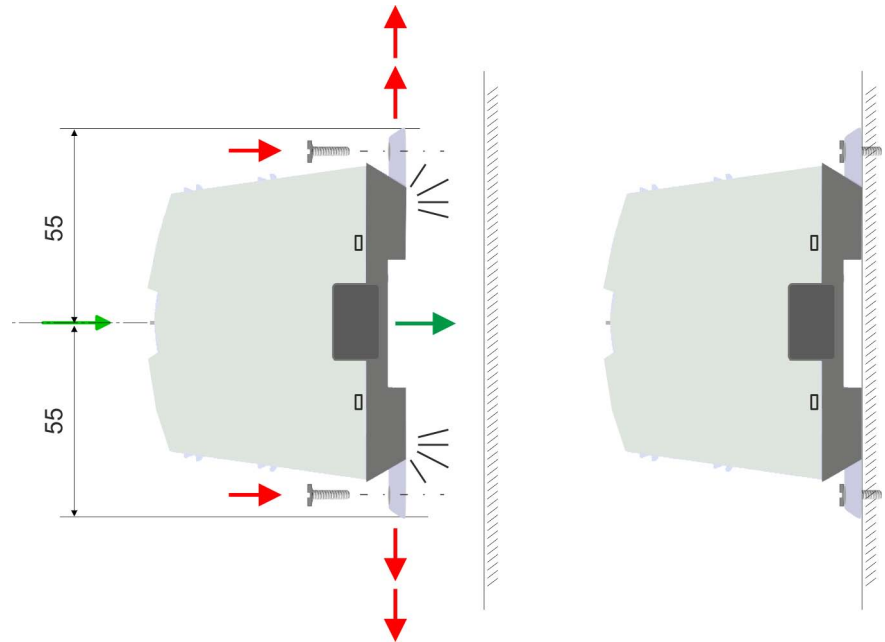

Dimensions in mm

1. ➤ The CPU has a locking lever on the upper and lower side. Pull these levers outwards as shown in the figure, until these engage 2x audible.
 - ⇨ By this openings on the locking levers get visible.
2. ➤ Use the appropriate screws to fix your CPU to your back wall. Consider the installation clearances for the CPU.
 - ⇨ The CPU is now mounted and can be wired.

2.4.1.2 Mounting with mounting rail

Proceeding

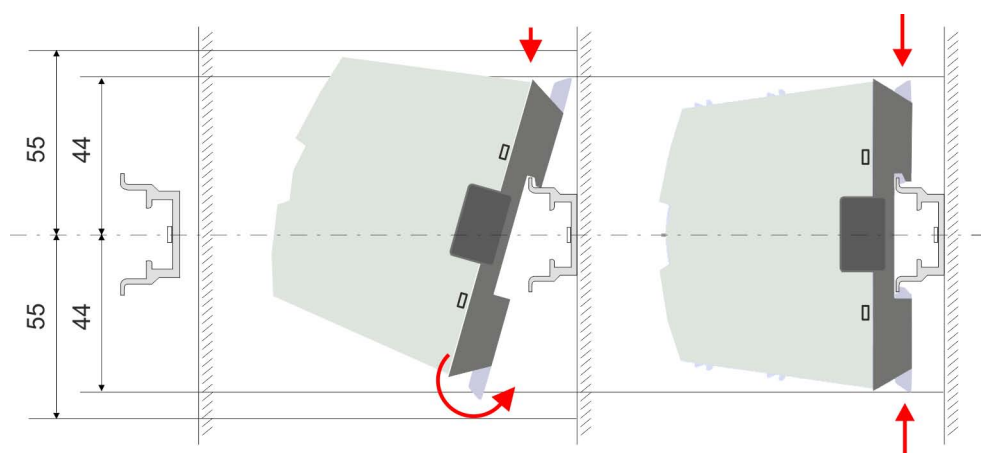

Dimensions in mm

1. ➤ Mount the mounting rail. Please consider that a clearance from the middle of the mounting rail of at least 44mm respectively 55mm above and below exists.

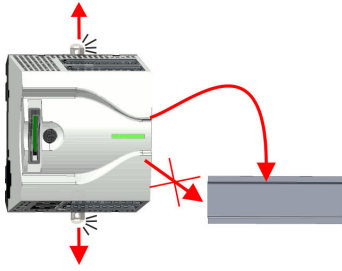

2. The CPU has a locking lever on the upper and lower side. Pull these levers outwards as shown in the figure, until these engage audible.



CAUTION!

It is not allowed to mount the module sideways on the mounting rail, as otherwise the module may be damaged.

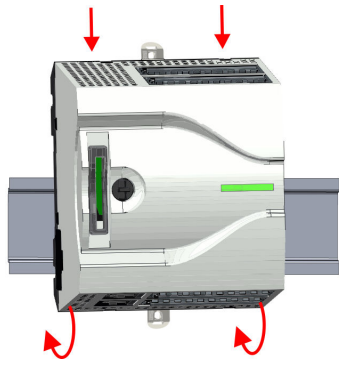

3. Plug the CPU from the top onto the mounting rail and turn the CPU downward until it rests on the mounting rail.

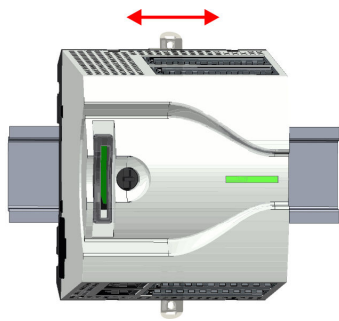

4. Move the CPU on the mounting rail at its position.

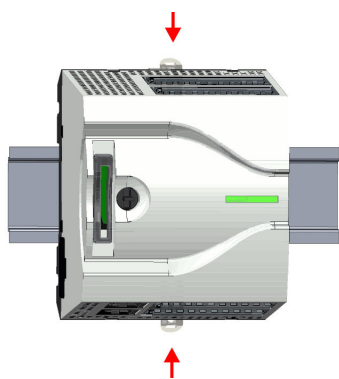

5. To fix the CPU at the mounting rail, move the locking levers back to the initial position.

⇒ The CPU is now mounted and can be wired.

2.4.2 Mounting the extension module

Proceeding

You have the possibility to extend the interfaces of the CPU by plugging an extension module. For this the extension module is plugged at the left side of the CPU. The mountings happens with the following proceeding:

1. ➤ Remove the bus cover with a screwdriver on the left side of the CPU.

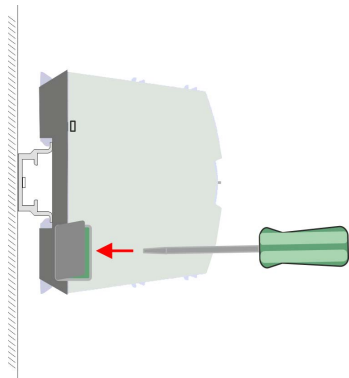

2. ➤ The extension module has a locking lever on the upper and lower side. Pull these levers outwards as shown in the figure, until these engage audible.

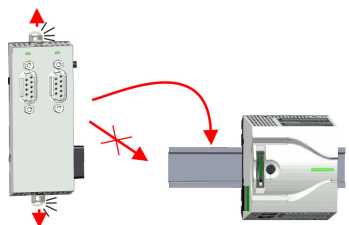

CAUTION!

It is not allowed to mount the module sideways on the mounting rail, as otherwise the module may be damaged.

3. ➤ To mount plug the extension module from the top onto the mounting rail and turn the extension module downward until it rests on the mounting rail.

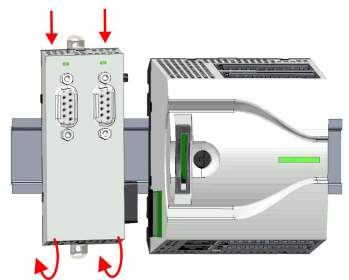

4. ➤ Attach the extension module to the CPU by sliding the extension module on the mounting rail to the right until the interface connector slightly locks into the CPU.

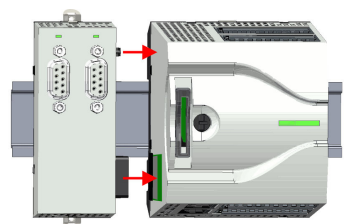

5. ➤ To fix the extension module at the mounting rail, move the locking levers back to the initial position.

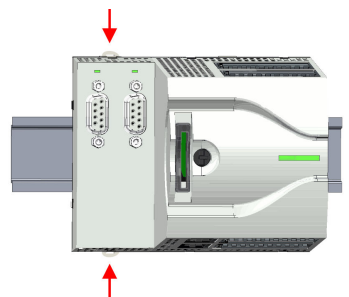

2.4.3 Mounting periphery module

Proceeding

You have the possibility to extend the periphery area of the CPU by plugging up to 8 periphery modules. For this the periphery modules are plugged at the right side of the CPU. The mountings happens with the following proceeding:

1. ➤ Remove the bus cover with a screwdriver on the right side of the CPU.

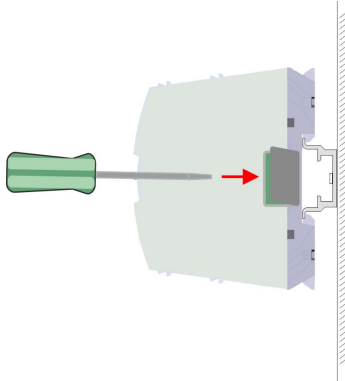

2. ➤ Each periphery module has a locking lever on its upper and lower side. Pull these levers outwards as shown in the figure, until these engage audible.

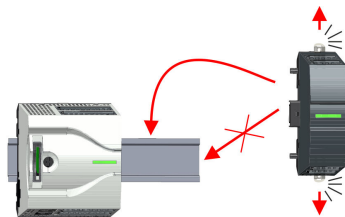

CAUTION!

It is not allowed to mount the module sideways on the mounting rail, as otherwise the module may be damaged.

3. ➤ To mount plug the periphery module from the top onto the mounting rail and turn the periphery module downward until it rests on the mounting rail.

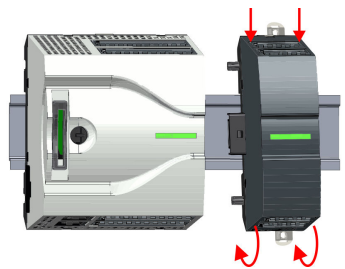

4. ➤ Attach the periphery module to the CPU by sliding the periphery module on the mounting rail to the left until the interface connector slightly locks into the CPU.

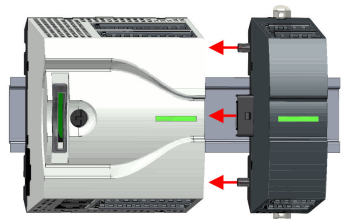

5. ➤ To fix the periphery module at the mounting rail, move the locking levers back to the initial position.

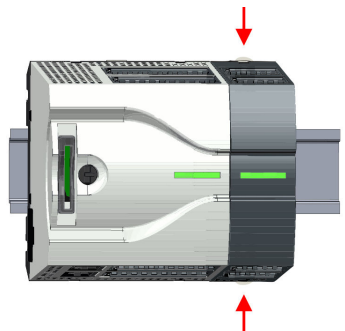

6. ➤ Proceed in this way with additional periphery modules.

2.5 Wiring



CAUTION!

Consider temperature for external cables!

Cables may experience temperature increase due to system heat dissipation. Thus the cabling specification must be chosen 5°C above ambient temperature!



CAUTION!

Separate insulation areas!

The system is specified for SELV/PELV environment. Devices, which are attached to the system must meet these specifications. Installation and cable routing other than SELV/PELV specification must be separated from the system's equipment!

2.5.1 Wiring CPU

CPU connector

For wiring the CPU has removable connectors. With the wiring of the connectors a "push-in" spring-clip technique is used. This allows a quick and easy connection of your signal and supply lines. The clamping off takes place by means of a screwdriver.

Data

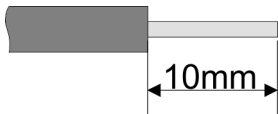

U_{max}	30V DC
I_{max}	10A
Cross section	0.2 ... 1.5mm ² (AWG 24 ... 16)
Stripping length	10mm

Use for wiring rigid wires respectively use wire sleeves. When using stranded wires you have to press the release button with a screwdriver during the wiring.

Wiring procedure

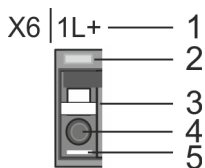

- 1 Labeling on the casing
- 2 Status LED
- 3 Release area
- 4 Connection hole for wire
- 5 Pin 1 of the connector is labelled by a white line

Insert wire

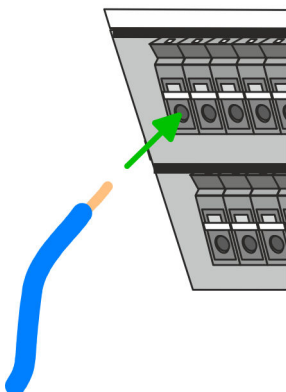

The wiring happens without a tool.

- Determine according to the casing labelling the connection position and insert through the round connection hole of the according contact your prepared wire until it stops, so that it is fixed.
- ⇒ By pushing the contact spring opens, thus ensuring the necessary contact pressure.

Remove wire

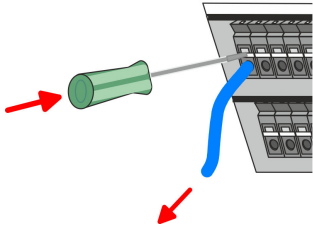

The wire is to be removed by means of a screwdriver with 2.5mm blade width.

1. ➤ Press with your screwdriver vertically at the release button.
⇒ The contact spring releases the wire.
2. ➤ Pull the wire from the round hole.

Standard wiring

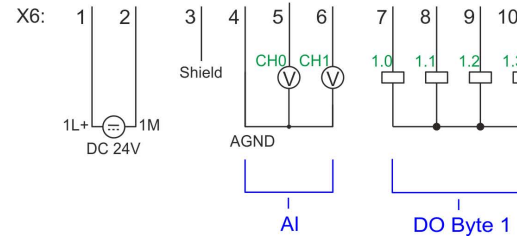
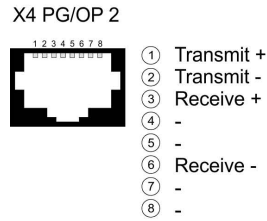
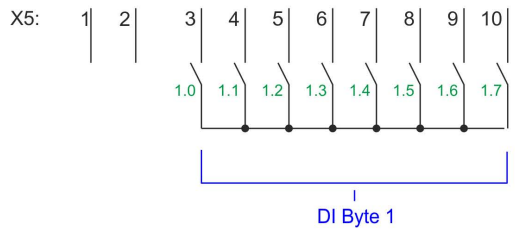
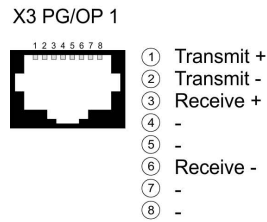
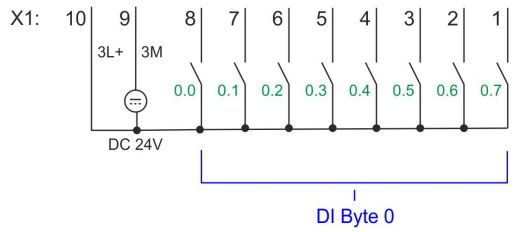
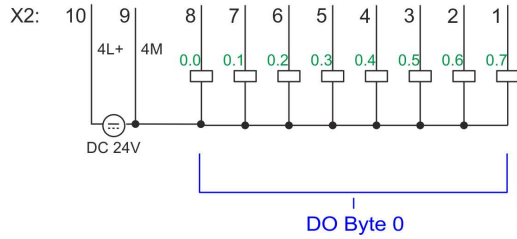
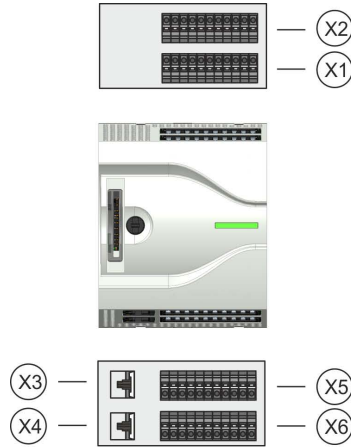

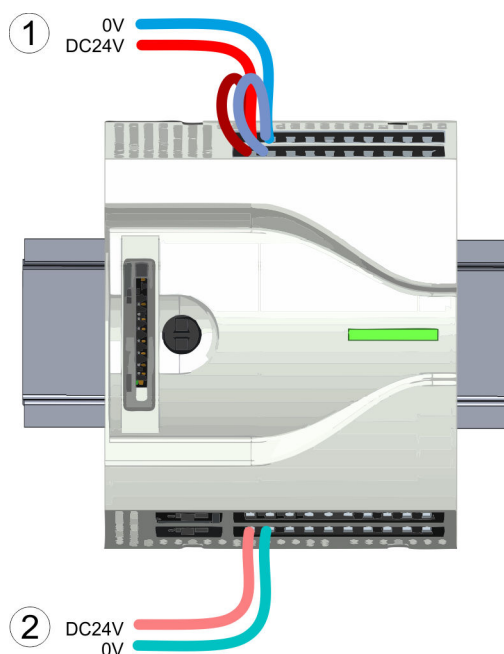

- (1) X2: 4L+: DC 24V power section supply for integrated outputs
 X1: 3L+: DC 24V power section supply for integrated inputs
- (2) X6: 1L+ DC 24V for electronic power supply



The electronic power section supply is internally protected against higher voltage by fuse. The fuse is located inside the CPU and can not be changed by the user.

Fusing



CAUTION!

- The power section supply of the internal DOs is to be externally protected with a 8A fuse (fast) respectively by a line circuit breaker 8A characteristics Z.

Remove connector

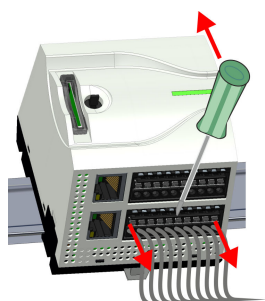

By means of a screwdriver there is the possibility to remove the connectors e.g. for module exchange with a fix wiring. For this each connector has indentations for unlocking at the top. Unlocking takes place by the following proceeding:

1. Remove connector:

Insert your screwdriver from above into one of the indentations.

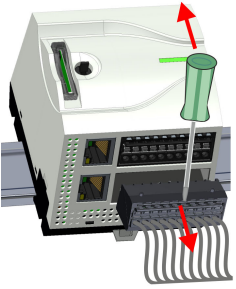

2. → Push the screwdriver backwards:
 - ⇒ The connector is unlocked and can be removed.

**CAUTION!**

Via wrong operation such as pressing the screwdriver downward, the release lever may be damaged.

3. → Plug connector:
The connector is plugged by plugging it directly into the release lever.

2.5.2 Wiring periphery module

Periphery module connector

For wiring the periphery module has removable connectors. With the wiring of the connectors a "push-in" spring-clip technique is used. This allows a quick and easy connection of your signal and supply lines. The clamping off takes place by means of a screwdriver.

Data

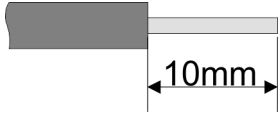

U_{max}	240V AC / 30V DC
I_{max}	10A
Cross section	0.2 ... 1.5mm ² (AWG 24 ... 16)
Stripping length	10mm

Use for wiring rigid wires respectively use wire sleeves. When using stranded wires you have to press the release button with a screwdriver during the wiring.

Wiring procedure

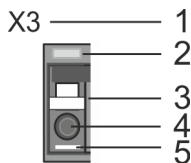

- 1 Labeling on the casing
- 2 Status LED
- 3 Release area
- 4 Connection hole for wire
- 5 Pin 1 of the connector is labelled by a white line

Insert wire

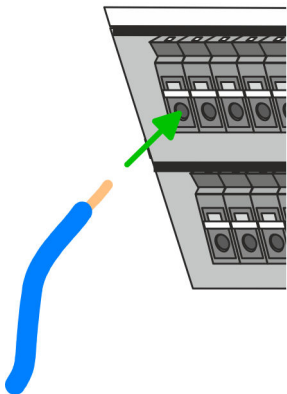

The wiring happens without a tool.

- Determine according to the casing labelling the connection position and insert through the round connection hole of the according contact your prepared wire until it stops, so that it is fixed.
 - ⇒ By pushing the contact spring opens, thus ensuring the necessary contact pressure.

Remove wire

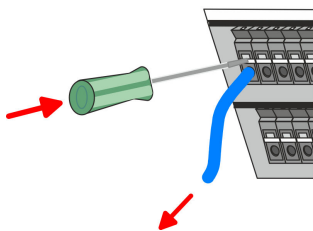

The wire is to be removed by means of a screwdriver with 2.5mm blade width.

1. → Press with your screwdriver vertically at the release button.
 - ⇒ The contact spring releases the wire.
2. → Pull the wire from the round hole.

Fusing



CAUTION!

- The power section supply of the output modules DO16 is to be externally protected with a 10A fuse (fast) respectively by a line circuit breaker 10A characteristics Z.
- The power section supply of the output part of the DIO8 is to be externally protected with a 5A fuse (fast) respectively by a line circuit breaker 5A characteristics Z.

Remove connector

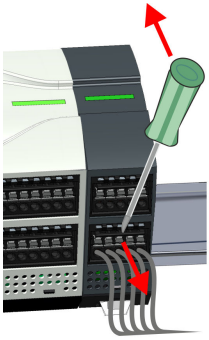

By means of a screwdriver there is the possibility to remove the connectors e.g. for module exchange with a fix wiring. For this each connector has indentations for unlocking at the top. Unlocking takes place by the following proceeding:

1. Remove connector:

Insert your screwdriver from above into one of the indentations.

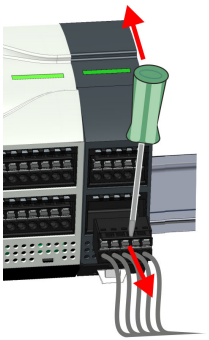

2. Push the screwdriver backwards:

⇒ The connector is unlocked and can be removed.



CAUTION!

Via wrong operation such as pressing the screwdriver downward, the release lever may be damaged.

3. Plug connector:

The connector is plugged by plugging it directly into the release lever.

2.6 Demounting

2.6.1 Demounting CPU

Remove connector

By means of a screwdriver there is the possibility to remove the connectors e.g. for module exchange with a fix wiring. For this each connector has indentations for unlocking at the top. Unlocking takes place by the following proceeding:

1. ➤ Power-off your system.
2. ➤ Remove connector:
Insert your screwdriver from above into one of the indentations.

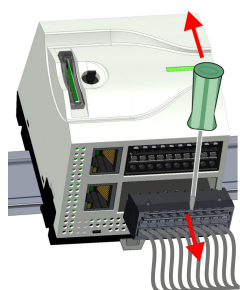
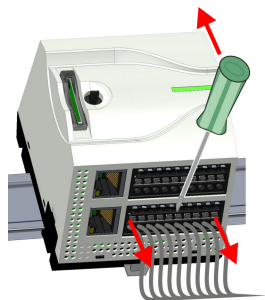

3. ➤ Push the screwdriver backwards:
⇒ The connector is unlocked and can be removed.



CAUTION!

Via wrong operation such as pressing the screwdriver downward, the connector may be damaged!

4. ➤ In this way, remove all plugged connectors on the CPU.

CPU replacement (stand-alone)

If more modules are connected to the CPU ↗ *'Option: CPU replacement in a system'* page 27. If no other modules are connected to the CPU, the CPU is replaced according to the following proceeding:

1. ➤ Use a screwdriver to pull the locking levers of the CPU outwards until these engage audible.

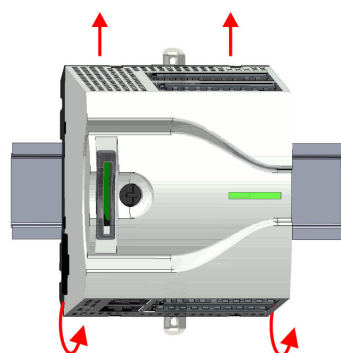
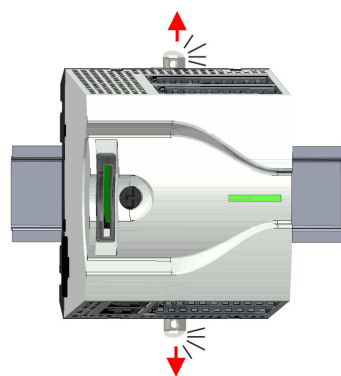

2. ➤ Remove the CPU with a rotation upwards from the mounting rail.

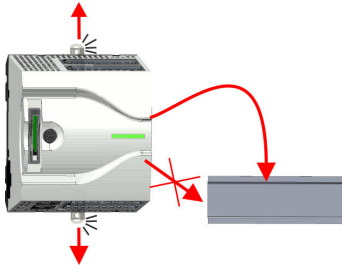

3. Pull the locking levers of the CPU outwards until these engage audible.



CAUTION!

It is not allowed to mount the module sideways on the mounting rail, as otherwise the module may be damaged!

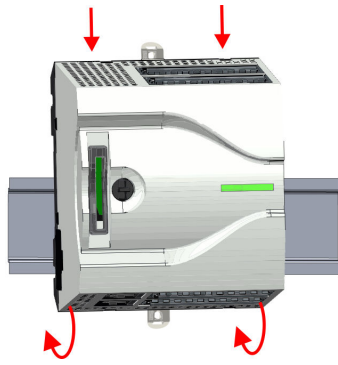

4. Plug the CPU from the top onto the mounting rail and turn the CPU downward until it rests on the mounting rail.

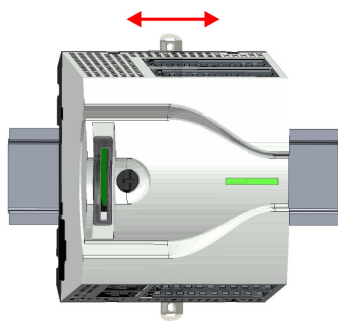

5. Move the CPU on the mounting rail at its position.

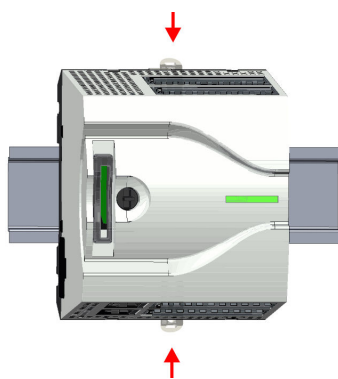

6. To fix the CPU at the mounting rail, move the locking levers back to the initial position.

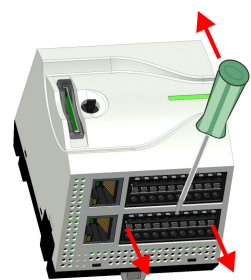

7. Remove the connectors, which are not necessary at the CPU.

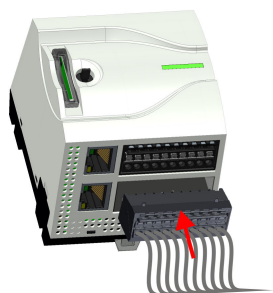

8. ➤ Plug again the wired connectors.
⇒ Now you can bring your system back into operation.

Option: CPU replacement in a system

In the following the replacement of a CPU in a system is shown:

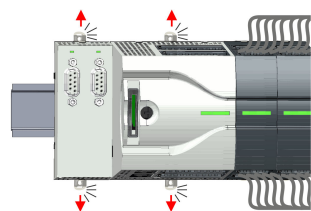

1. ➤ If there is an extension module connected to the CPU, you have to remove it from the CPU. For this use a screwdriver to pull the locking levers of the extension module and CPU outwards until these engage audible.

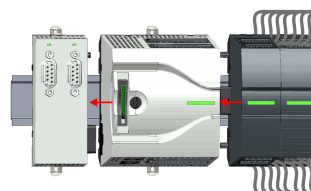

2. ➤ Disconnect all the modules, which are connected to the CPU by moving the CPU along with the extension module on the mounting rail.

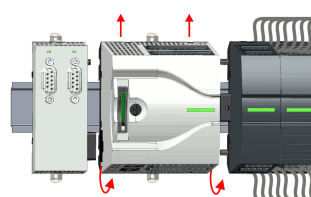

3. ➤ Remove the CPU with a rotation upwards from the mounting rail.

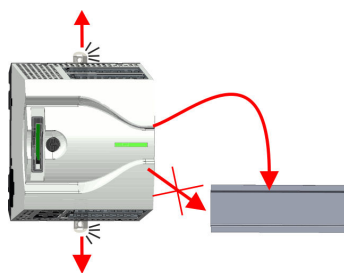

4. ➤ Pull the locking levers of the CPU outwards until these engage audible.



CAUTION!

It is not allowed to mount the module sideways on the mounting rail, as otherwise the module may be damaged!

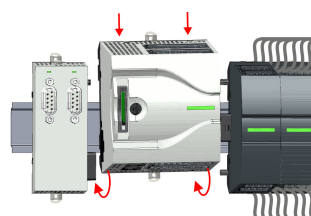

5. ➤ For mounting pull the locking levers of the CPU outwards until these engage audible. Plug the CPU from the top onto the mounting rail and turn the CPU downward until it rests on the mounting rail.

Demounting > Demounting CPU

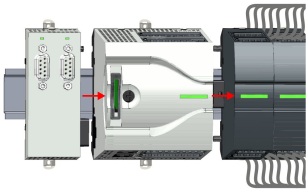

6. ➤ Rebind your modules by moving the CPU along with the extension module on the mounting rail.

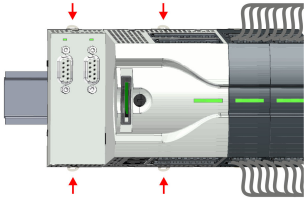

7. ➤ To fix the CPU at the mounting rail, move the locking levers back to the initial position.

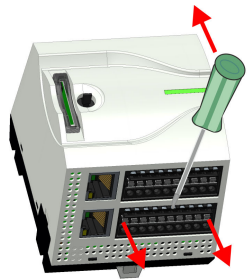

8. ➤ Remove the connectors, which are not necessary at the CPU.

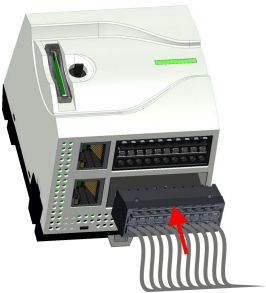

9. ➤ Plug again the wired connectors.
 ⇒ Now you can bring your system back into operation.

2.6.2 Demounting the extension module

Proceeding

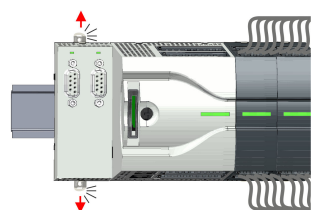

1. ➤ Power-off your system.
2. ➤ Remove the corresponding bus connectors.
3. ➤ Use a screwdriver to pull the locking levers of the extension module outwards until these engage audible.

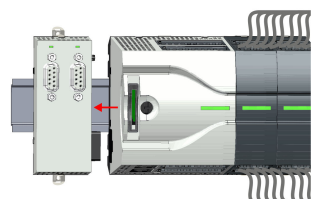

4. ➤ Remove the extension module from the CPU by sliding it on the mounting rail.

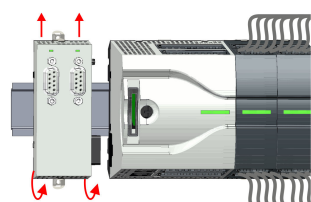

5. ➤ Remove the extension module with a rotation upwards from the mounting rail.

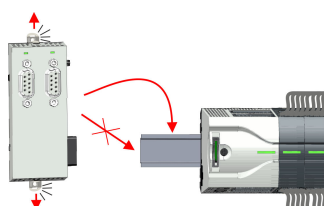

6. ➤ Pull the locking levers of the extension module outwards until these engage audible.



CAUTION!

It is not allowed to mount the module sideways on the mounting rail, as otherwise the module may be damaged!

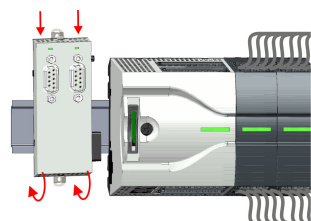

7. ➤ Plug the extension module from the top onto the mounting rail and turn the extension module downward until it rests on the mounting rail.

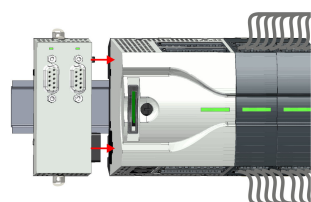

8. ➤ Reattach the extension module to the CPU by sliding the extension module on the mounting rail to the right until the interface connector slightly locks into the CPU.

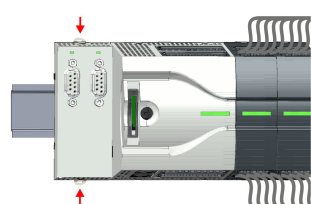

9. ➤ Move the locking levers back to the initial position.
10. ➤ Plug the corresponding bus connectors.
 - ⇒ Now you can bring your system back into operation.

2.6.3 Demounting periphery module

Remove connector

By means of a screwdriver there is the possibility to remove the connectors e.g. for module exchange with a fix wiring. For this each connector has indentations for unlocking at the top. Unlocking takes place by the following proceeding:

1. ➤ Power-off your system.



CAUTION!

Make sure that the working contacts from the relay module are disconnected from the power supply!

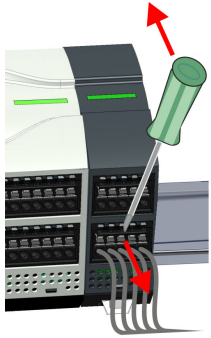

2. ➤ Remove connector:

Insert your screwdriver from above into one of the indentations.

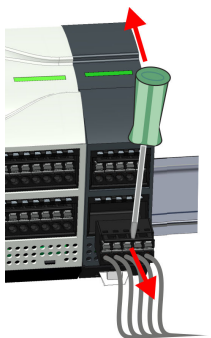

3. ➤ Push the screwdriver backwards:

⇒ The connector is unlocked and can be removed.



CAUTION!

Via wrong operation such as pressing the screwdriver downward, the connector may be damaged!

4. ➤ In this way, remove all plugged connectors on the periphery module.

Replace the periphery module

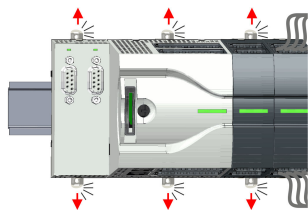

1. ➤ Remove the modules that are connected to the module to be replaced by pulling their release levers outwards until these engage audible ...

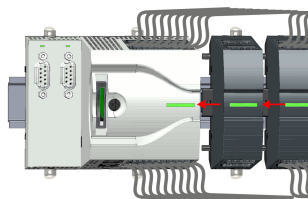

2. ➤ ... and move the modules accordingly.

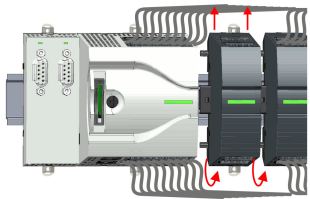

3. ➔ Remove the periphery module with a rotation upwards from the mounting rail.

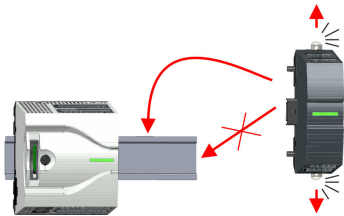

4. ➔ Pull the locking levers outwards until these engage audible.



CAUTION!

It is not allowed to mount the module sideways on the mounting rail, as otherwise the module may be damaged!

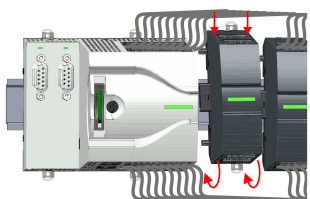

5. ➔ Plug the periphery module from the top onto the mounting rail and turn the periphery module downward until it rests on the mounting rail.

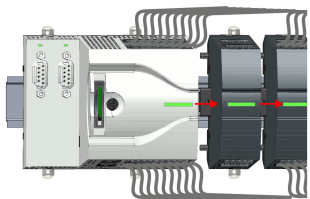

6. ➔ Reconnect all modules by pushing them together again on the mounting rail.

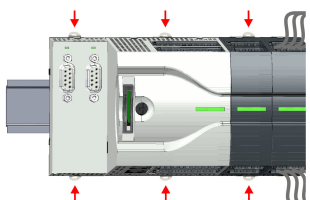

7. ➔ Move the locking levers back to the initial position.



8. ➔ Remove the connectors, which are not necessary.

Demounting > Demounting periphery module



9.  Plug again the wired connectors.
 - ⇒ Now you can bring your system back into operation.

2.7 Installation guidelines

General	<p>The installation guidelines contain information about the interference free deployment of a PLC system. There is the description of the ways, interference may occur in your PLC, how you can make sure the electromagnetic compatibility (EMC), and how you manage the isolation.</p>
What does EMC mean?	<p>Electromagnetic compatibility (EMC) means the ability of an electrical device, to function error free in an electromagnetic environment without being interfered respectively without interfering the environment.</p> <p>The components of VIPA are developed for the deployment in industrial environments and meets high demands on the EMC. Nevertheless you should project an EMC planning before installing the components and take conceivable interference causes into account.</p>
Possible interference causes	<p>Electromagnetic interferences may interfere your control via different ways:</p> <ul style="list-style-type: none">■ Electromagnetic fields (RF coupling)■ Magnetic fields with power frequency■ Bus system■ Power supply■ Protected earth conductor <p>Depending on the spreading medium (lead bound or lead free) and the distance to the interference cause, interferences to your control occur by means of different coupling mechanisms.</p> <p>There are:</p> <ul style="list-style-type: none">■ galvanic coupling■ capacitive coupling■ inductive coupling■ radiant coupling
Basic rules for EMC	<p>In the most times it is enough to take care of some elementary rules to guarantee the EMC. Please regard the following basic rules when installing your PLC.</p> <ul style="list-style-type: none">■ Take care of a correct area-wide grounding of the inactive metal parts when installing your components.<ul style="list-style-type: none">– Install a central connection between the ground and the protected earth conductor system.– Connect all inactive metal extensive and impedance-low.– Please try not to use aluminium parts. Aluminium is easily oxidizing and is therefore less suitable for grounding.■ When cabling, take care of the correct line routing.<ul style="list-style-type: none">– Organize your cabling in line groups (high voltage, current supply, signal and data lines).– Always lay your high voltage lines and signal respectively data lines in separate channels or bundles.– Route the signal and data lines as near as possible beside ground areas (e.g. suspension bars, metal rails, tin cabinet).

- Proof the correct fixing of the lead isolation.
 - Data lines must be laid isolated.
 - Analog lines must be laid isolated. When transmitting signals with small amplitudes the one sided laying of the isolation may be favourable.
 - Lay the line isolation extensively on an isolation/protected earth conductor rail directly after the cabinet entry and fix the isolation with cable clamps.
 - Make sure that the isolation/protected earth conductor rail is connected impedance-low with the cabinet.
 - Use metallic or metallised plug cases for isolated data lines.
- In special use cases you should appoint special EMC actions.
 - Consider to wire all inductivities with erase links.
 - Please consider luminescent lamps can influence signal lines.
- Create a homogeneous reference potential and ground all electrical operating supplies when possible.
 - Please take care for the targeted employment of the grounding actions. The grounding of the PLC serves for protection and functionality activity.
 - Connect installation parts and cabinets with your PLC in star topology with the isolation/protected earth conductor system. So you avoid ground loops.
 - If there are potential differences between installation parts and cabinets, lay sufficiently dimensioned potential compensation lines.

Isolation of conductors

Electrical, magnetically and electromagnetic interference fields are weakened by means of an isolation, one talks of absorption. Via the isolation rail, that is connected conductive with the rack, interference currents are shunt via cable isolation to the ground. Here you have to make sure, that the connection to the protected earth conductor is impedance-low, because otherwise the interference currents may appear as interference cause.

When isolating cables you have to regard the following:

- If possible, use only cables with isolation tangle.
- The hiding power of the isolation should be higher than 80%.
- Normally you should always lay the isolation of cables on both sides. Only by means of the both-sided connection of the isolation you achieve high quality interference suppression in the higher frequency area. Only as exception you may also lay the isolation one-sided. Then you only achieve the absorption of the lower frequencies. A one-sided isolation connection may be convenient, if:
 - the conduction of a potential compensating line is not possible.
 - analog signals (some mV respectively μA) are transferred.
 - foil isolations (static isolations) are used.
- With data lines always use metallic or metallised plugs for serial couplings. Fix the isolation of the data line at the plug rack. Do not lay the isolation on the PIN 1 of the plug bar!
- At stationary operation it is convenient to strip the insulated cable interruption free and lay it on the isolation/protected earth conductor line.
- To fix the isolation tangles use cable clamps out of metal. The clamps must clasp the isolation extensively and have well contact.
- Lay the isolation on an isolation rail directly after the entry of the cable in the cabinet. Lead the isolation further on to your PLC and don't lay it on there again!



CAUTION!

Please regard at installation!

At potential differences between the grounding points, there may be a compensation current via the isolation connected at both sides.

Remedy: Potential compensation line

2.8 General data

Conformity and approval

Conformity		
CE	2014/35/EU	Low-voltage directive
	2014/30/EU	EMC directive
Approval		
UL	-	Refer to Technical data
others		
RoHS	2011/65/EU	Restriction of the use of certain hazardous substances in electrical and electronic equipment

Protection of persons and device protection

Type of protection	-	IP20
Electrical isolation		
to the field bus	-	electrically isolated
to the process level	-	electrically isolated
Insulation resistance	-	-
Insulation voltage to reference earth		
Inputs / outputs	-	AC / DC 50V, test voltage AC 500V
Protective measures	-	against short circuit

Environmental conditions to EN 61131-2

Climatic		
Storage / transport	EN 60068-2-14	-25...+70°C
Operation		
Horizontal installation hanging	EN 61131-2	0...+60°C
Horizontal installation lying	EN 61131-2	0...+60°C
Vertical installation	EN 61131-2	0...+60°C
Air humidity	EN 60068-2-30	RH1 (without condensation, rel. humidity 10...95%)
Pollution	EN 61131-2	Degree of pollution 2
Installation altitude max.	-	2000m
Mechanical		
Oscillation	EN 60068-2-6	1g, 9Hz ... 150Hz
Shock	EN 60068-2-27	15g, 11ms

General data

Mounting conditions		
Mounting place	-	In the control cabinet
Mounting position	-	Horizontal and vertical

EMC	Standard	Comment	
Emitted interference	EN 61000-6-4	Class A (Industrial area)	
Noise immunity zone B	EN 61000-6-2	Industrial area	
		EN 61000-4-2	ESD 8kV at air discharge (degree of severity 3), 4kV at contact discharge (degree of severity 2)
		EN 61000-4-3	HF field immunity (casing) 80MHz ... 1000MHz, 10V/m, 80% AM (1kHz) 1.4GHz ... 2.0GHz, 3V/m, 80% AM (1kHz) 2GHz ... 2.7GHz, 1V/m, 80% AM (1kHz)
		EN 61000-4-6	HF conducted 150kHz ... 80MHz, 10V, 80% AM (1kHz)
		EN 61000-4-4	Burst, degree of severity 3
	EN 61000-4-5	Surge, degree of severity 3 *	

*) Due to the high-energetic single pulses with Surge an appropriate external protective circuit with lightning protection elements like conductors for lightning and overvoltage is necessary.

3 Hardware description

3.1 Properties

M13-CCF0000

- SPEED7 technology integrated
- Programmable via VIPA SPEED7 Studio, Siemens SIMATIC Manager or Siemens TIA Portal
- 64kbyte work memory integrated (32kbyte code, 32kbyte data)
- Work memory expandable up to max. 128kbyte (64kbyte code, 64kbyte data)
- 128kbyte load memory integrated
- Slot for external storage media (lockable)
- Status LEDs for operating state and diagnostics
- X1/X5: DI 16xDC24V with status indication integrated
- X2/X6: DO 12xDC24V 0.5A with status indication integrated
- X3/X4: Ethernet PG/OP channel for active and passive Communication integrated
- X6: AI 2x12Bit (single ended) integrated
- Technological functions: 4 channels for counter, frequency measurement and 2 channels for pulse width modulation
- Pulse Train via SFB 49 (PULSE)
- PROFINET IO controller and I-Device via Ethernet PG/OP channel
- *WebVisu* project via Ethernet PG/OP channel
- Option: Extension module 2xRS485
- Option: max. 8 periphery modules
- I/O address area digital/analog 2048byte
- 512 timer/counter, 8192 flag byte

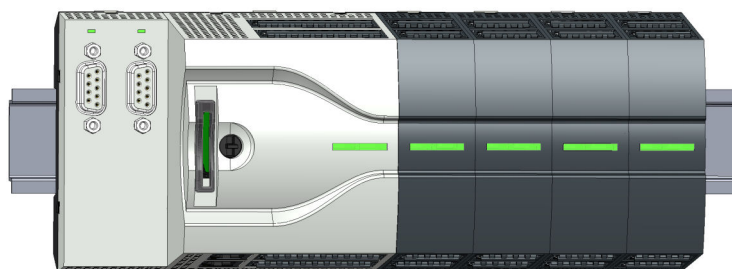

Ordering data

Type	Order number	Description
CPU M13C	M13-CCF0000	System MICRO CPU M13C with options to extend work memory, DI 16xDC24V, DO 12xDC24 0.5A, AI 2x12bit and 4 channels technological functions
EM M09	M09-0CB00	System MICRO extension: Serial interface 2x (RS485/RS422, MPI, option PROFIBUS DP slave)

3.2 Structure

3.2.1 System MICRO CPU M13C

CPU M13-CCF0000

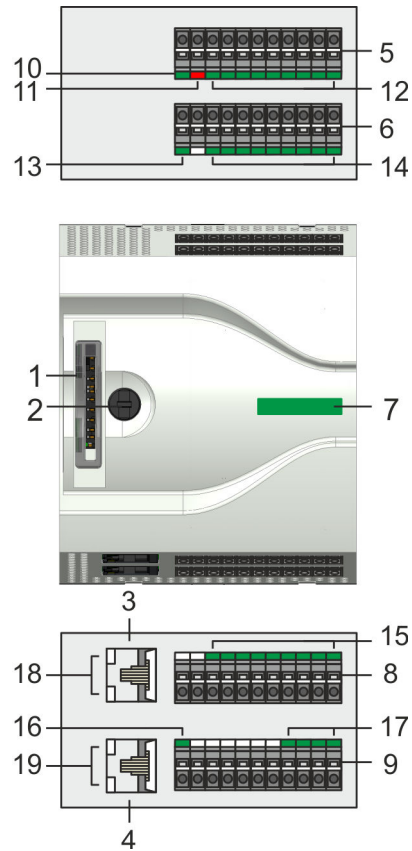

- 1 Slot for external storage media (lockable)
- 2 Operating mode switch CPU
- 3 X3: Ethernet PG/OP channel
- 4 X4: Ethernet PG/OP channel
- 5 X2: Connector DO +0.0 ... DO +0.7
- 6 X1: Connector DI +0.0 ... DI +0.7
- 7 Status bar CPU
- 8 X5: Connector DI +1.0 ... DI +1.7
- 9 X6: Connector electronic section supply, AI, DO +1.0 ... DO +1.3
- 10 X2 4L+: LED DC 24V power section supply for on-board DO
- 11 X2 4M: LED on error, overload respectively short circuit at the outputs
- 12 X2 DO +0.x: LEDs DO +0.0 ... DO +0.7
- 13 X1 3L+: LED DC 24V power section supply for on-board DI
- 14 X1 DI +0.x: LEDs DI +0.0 ... DI +0.7
- 15 X5 DI +1.x: LEDs DI +1.0 ... DI +1.7
- 16 X6 1L+: LED DC 24V for electronic section supply
- 17 X6 DO +1.x: LEDs DO +1.0 ... DO +1.3
- 18 X3 Ethernet PG/OP channel: LEDs Link/Activity
- 19 X4 Ethernet PG/OP channel: LEDs Link/Activity

3.2.2 Interfaces

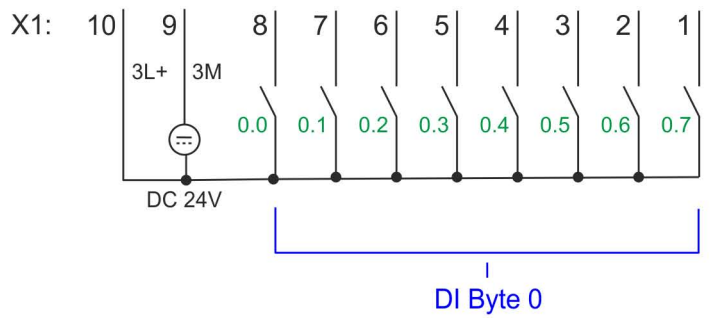
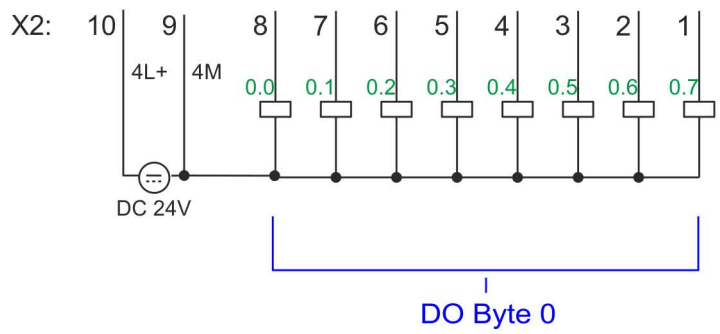
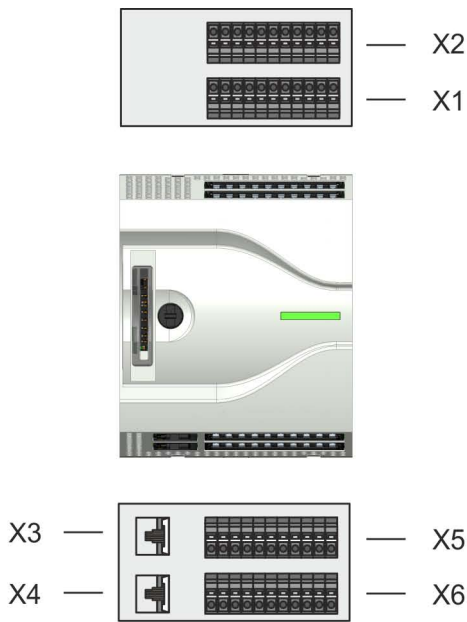

X3 PG/OP 1

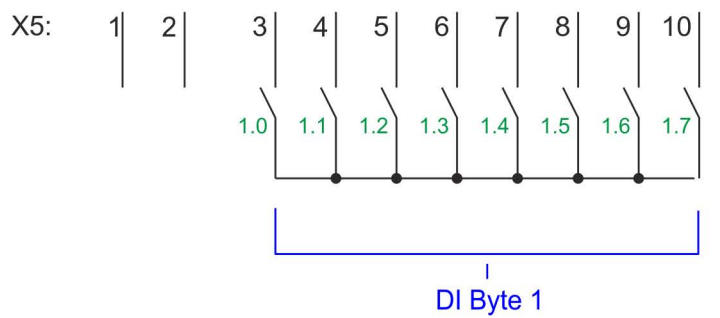
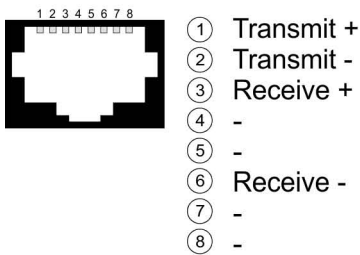

X4 PG/OP 2

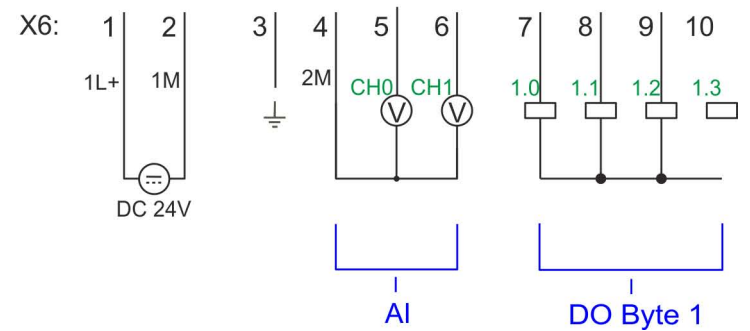
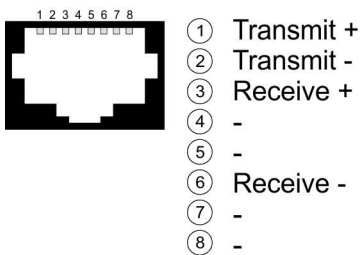

X1: DI byte 0

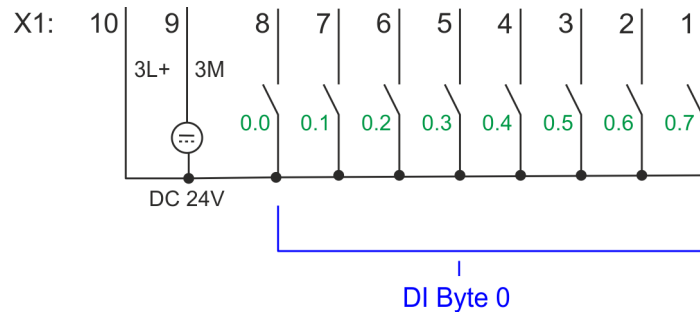







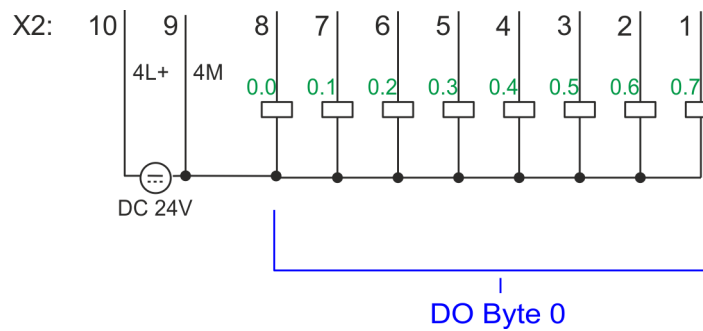



X1	Function	Type	LED ■ green	Description
1	DI 0.7	I	■	Digital input DI 7 / Counter 2 (B) / Frequency 2 *
2	DI 0.6	I	■	Digital input DI 6 / Counter 2 (A) *
3	DI 0.5	I	■	Digital input DI 5
4	DI 0.4	I	■	Digital input DI 4 / Counter 1 (B) / Frequency 1 *
5	DI 0.3	I	■	Digital input DI 3 / Counter 1 (A) *
6	DI 0.2	I	■	Digital input DI 2
7	DI 0.1	I	■	Digital input DI 1 / Counter 0 (B) / Frequency 0 *
8	DI 0.0	I	■	Digital input DI 0 / Counter 0 (A) *
9	0 V	I		3M: GND for onboard DI power section supply
10	DC 24V	I	■	3L+: DC 24V for onboard DI power section supply

*) Max. input frequency 100kHz otherwise 1kHz.

X2: DO byte 0



X2	Function	Type	LED	Description
			 green	
1	DO 0.7	O		Digital output DO 7
2	DO 0.6	O		Digital output DO 6
3	DO 0.5	O		Digital output DO 5
4	DO 0.4	O		Digital output DO 4
5	DO 0.3	O		Digital output DO 3 / Output channel counter 3
6	DO 0.2	O		Digital output DO 2 / Output channel counter 2
7	DO 0.1	O		Digital output DO 1 / PWM 1 / Output channel counter 1
8	DO 0.0	O		Digital output DO 0 / PWM 0 / Output channel counter 0
9	0 V	I	 red	4M: GND for onboard DO power section supply / GND PWM LED (red) is on at short circuit respectively overload
10	DC 24V	I		4L+: DC 24V for onboard DO power section supply

X3/X4: Ethernet PG/OP channel

8pin RJ45 jack:

- The RJ45 jack serves as interface to the Ethernet PG/OP channel.
- This interface allows you to program respectively remote control your CPU and to access the internal web server.
- The Ethernet PG/OP channel (X3/X4) is designed as switch. This enables PG/OP communication via the connections X3 and X4.
- Configurable connections are possible.
- DHCP respectively the assignment of the network configuration with a DHCP server is supported.
- Default diagnostics addresses: 2025 ... 2040
- At the first commissioning respectively after a factory reset the Ethernet PG/OP channel has no IP address. For online access to the CPU via the Ethernet PG/OP channel, valid IP address parameters have to be assigned to this by means of your configuration tool. This is called "initialization".
- Via the Ethernet PG/OP channel, you have access to:
 - Device web page, where you can find information on firmware status, connected peripherals, current cycle times, etc.
 - *WebVisu* project, which is to be created in the *SPEED7 Studio*.
 - PROFINET IO controller or the PROFINET I-Device.

↪ *Chap. 4.6 'Hardware configuration - Ethernet PG/OP channel' page 71*

X5: DI byte 1

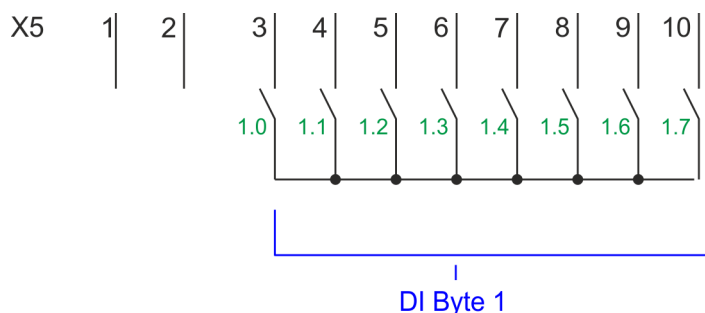

X5	Function	Type	LED green	Description
1	-	-		reserved
2	-	-		reserved
3	DI 1.0	I	■	Digital input DI 8
4	DI 1.1	I	■	Digital input DI 9 / Counter 3 (A) *
5	DI 1.2	I	■	Digital input DI 10 / Counter 3 (B) / Frequency 3 *
6	DI 1.3	I	■	Digital input DI 11 / Gate 3 *
7	DI 1.4	I	■	Digital input DI 12
8	DI 1.5	I	■	Digital input DI 13
9	DI 1.6	I	■	Digital input DI 14
10	DI 1.7	I	■	Digital input DI 15 / Latch 3 *

*) Max. input frequency 100kHz otherwise 1kHz.

X6: DC 24V, AI, DO byte 1

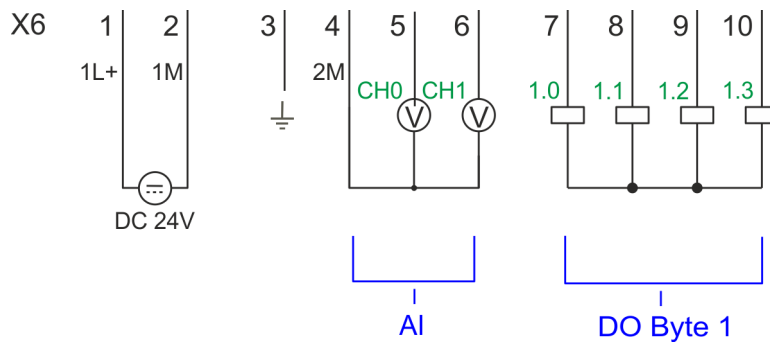

X6	Function	Type	LED green	Description
1	1L+	I	■	1L+: DC 24V for electronic section supply
2	1M	I		1M: DC 0V for electronic section supply
3	Shield	I		Shield
4	2M	I		2M: Ground for analog inputs
5	AI 0	I		Analog input AI 0
6	AI 1	I		Analog input AI 1
7	DO 1.0	O	■	Digital output DO 8
8	DO 1.1	O	■	Digital output DO 9
9	DO 1.2	O	■	Digital output DO 10
10	DO 1.3	O	■	Digital output DO 11

X6: Electronic power supply

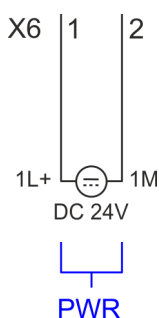

The CPU has an integrated power supply. The power supply has to be provided with DC 24V. Via the power supply not only the internal electronic of the CPU is provided with voltage, but also the electronic from the integrated IO components. The power supply is protected against polarity inversion and over current.

3.2.3 LEDs

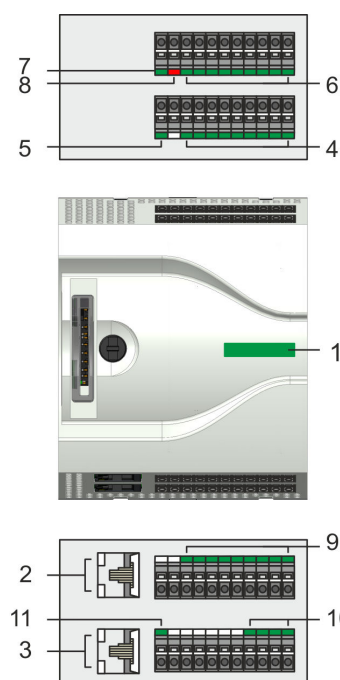

- 1 Status bar CPU
- 2 X3 Ethernet PG/OP channel: LEDs Link/Activity
- 3 X4 Ethernet PG/OP channel: LEDs Link/Activity
- 4 X1 DI +0.x: LEDs DI +0.0 ... DI +0.7
- 5 X1 3L+: LED DC 24V power section supply for on-board DI
- 6 X2 DO +0.x: LEDs DO +0.0 ... DO +0.7
- 7 X2 4L+: LED DC 24V power section supply for on-board DO
- 8 X2 4M: LED on error, overload respectively short circuit at the outputs
- 9 X5 DI +1.x: LEDs DI +1.0 ... DI +1.7
- 10 X6 DO +1.x: LEDs DO +1.0 ... DO +1.3
- 11 X6 1L+: LED DC 24V for electronic section supply

Status bar CPU



Status bar	Function
green	CPU - RUN: CPU is in state RUN without error. 46
yellow	CPU - STOP: CPU is in STOP state. 46
red	CPU - system fault: System error occurred. 46

Ethernet PG/OP channel



X3/X4	Function
green	Ethernet PG/OP channel X3/X4: Link/Activity 47
yellow	Ethernet PG/OP channel X3/X4: Speed 47

Structure > LEDs



X1 DI +0.x

Digital input	LED  green	Description
DI +0.0 ... DI +0.7		Digital input I+0.0 ... 0.7 has "1" signal
	<input type="checkbox"/>	Digital input I+0.0 ... 0.7 has "0" signal



X1 3L+

Power supply	LED  green	Description
3L+		DC 24V power section supply inputs OK
	<input type="checkbox"/>	DC 24V power section supply inputs not available



X2 DO +0.x

Digital output	LED  green	Description
DO +0.0 ... DO +0.7		Digital output Q+0.0 ... 0.7 has "1" signal
	<input type="checkbox"/>	Digital output Q+0.0 ... 0.7 has "0" signal



X2 4L+

Power supply	LED  green	Description
4L+		DC 24V power section supply outputs OK
	<input type="checkbox"/>	DC 24V power section supply outputs not available

X2 4M

Error	LED  red	Description
4M		Error, overload respectively short circuit on the outputs
	<input type="checkbox"/>	no error

X5 DI +1.x

Digital input	LED  green	Description
DI +1.0 ... DI +1.7		Digital input I+1.0 ... 1.7 has "1" signal
	<input type="checkbox"/>	Digital input I+1.0 ... 1.7 has "0" signal























X6 DO +1.x

Digital output	LED <input checked="" type="checkbox"/> green	Description
DO +1.0 ... DO +1.3	<input checked="" type="checkbox"/>	Digital output Q+1.0 ... 1.3 has "1" signal
	<input type="checkbox"/>	Digital output Q+1.0 ... 1.3 has "0" signal

X6 1L+





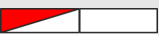

Power supply	LED <input checked="" type="checkbox"/> green	Description
1L+	<input checked="" type="checkbox"/>	DC 24V electronic section supply OK
	<input type="checkbox"/>	DC 24V electronic section supply not available

3.2.3.1 Status bar CPU

LED	Description
Start-up	
	LED yellow blinks with 1Hz: State of the CPU after PowerON
	LEDs green are blinking with 2Hz: During the start-up (OB 100) the status bar blinks for at least 3s.
Operation	
	LED yellow on: CPU is in STOP state.
	LED red on: CPU is in error state.
	LEDs green on: CPU is in RUN state without error.
	LED red blinks with 1Hz and LED green is on: CPU is in RUN state with error/warning.
	LED red on and LED green blinks with 1Hz: CPU is in STOP state, configured holding point reached.
	LED red blinks with 1Hz and LED green blinks with 2Hz: Diagnostic messages detected during start-up.
	LED red on and LED yellow on: CPU is in error state. There is a system error or an internal error has occurred. Here a write access is made to the memory card. As long as the LEDs red and yellow are on, do not remove the memory card.
	LED yellow blinks with 2Hz: Hardware configuration is loaded.
	LEDs green are blinking with 1Hz: Blinking test (started via configuration tool)
	LED green on and LED green flickers: Access to the memory card in the RUN state.
	LED red blinks with 1Hz and LED green flickers: Access to the memory card with CPU is in RUN state with error/warning.
	LED yellow flickers: Access to the memory card in STOP state.
Overall reset	
	LED yellow blinks with 1Hz: Overall reset is requested
	LED yellow blinks with 2Hz: Overall reset is executed.
	LED yellow on: Overall reset was successfully finished.
Factory reset	
	LED yellow blinks with 2Hz: Reset to factory setting is executed.
	LED red blinks with 1Hz and LED yellow blinks with 1Hz: Reset to factory settings was finished without errors. Please perform a power cycle!
Firmware update	
	LED red and LED yellow are alternately blinking with 1Hz: A new firmware is available on the memory card.
	LED yellow blinks with 2Hz: A firmware update is in progress.
	LED yellow flickers: Access the memory card during the firmware update.
	LED red and LED yellow are blinking with 1Hz: Firmware update finished without error. Please perform a power cycle!
	LED red blinks with 1Hz: Error during Firmware update.

3.2.3.2 LEDs Ethernet PG/OP channel

X3/X4: LEDs

L/A Link/Activity	S Speed	Description
 green	 yellow	
	X	The Ethernet PG/OP channel is physically connected to the Ethernet interface.
<input type="checkbox"/>	X	There is no physical connection.
	X	Blinking: Shows Ethernet activity.
		The Ethernet interface of the Ethernet PG/OP channel has a transfer rate of 100Mbit.
	<input type="checkbox"/>	The Ethernet interface of the Ethernet PG/OP channel has a transfer rate of 10Mbit.
not relevant: X		

3.2.4 Memory management

General

The CPU has an integrated memory. Information about the capacity of the memory may be found at the front of the CPU. The memory is divided into the following parts:

- Load memory 128kbyte
- Code memory (50% of the work memory)
- Data memory (50% of the work memory)
- Work memory 64kbyte
 - There is the possibility to extend the work memory to its maximum capacity 128kbyte by means of a VSC.

3.2.5 Slot for storage media

Overview

In this slot you can insert the following storage media:

- VSD - **VIPA SD-Card**
 - External memory card for programs and firmware.
- VSC - **VIPASetCard**
 - External memory card (VSD) for programs and firmware with the possibility to unlock optional functions like work memory and field bus interfaces.
 - These functions can be purchased separately. ↪ *Chap. 4.15 'Deployment storage media - VSD, VSC' page 98*
 - To activate the corresponding card is to be installed and a *Overall reset* is to be established. ↪ *Chap. 4.12 'Overall reset' page 94*



To avoid malfunctions, you should use memory cards of VIPA. These correspond to the industrial standard. A list of the currently available VSD respectively VSC can be found at www.vipa.com

3.2.6 Buffering mechanisms

The CPU has a capacitor-based mechanism to buffer the internal clock in case of power failure for max. 30 days. With PowerOFF the content of the RAM is automatically stored in the Flash (NVRAM).

**CAUTION!**

Please connect the CPU for approximately 1 hour to the power supply, so that the internal buffering mechanism is loaded accordingly.

In case of failure of the buffer mechanism Date and Time 01.09.2009 00:00:00 set. Additionally, you receive a diagnostics message. ↪ *Chap. 4.19 'Diagnostic entries' page 105*

3.2.7 Operating mode switch

General

- With the operating mode switch you may switch the CPU between STOP and RUN.
- During the transition from STOP to RUN the operating mode START-UP is driven by the CPU.
- Placing the switch to MR (**M**emory **R**eset), you request an overall reset with following load from memory card, if a project there exists.

3.3 Option: Extension module EM M09 2x serial interface

EM M09



X1 PtP

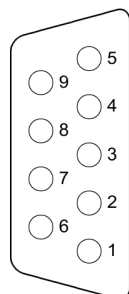

- ① n. c.
- ② TxD-P (line B) - RS422
- ③ RxD-P (line B) - RS422
RxD/TxD-P (line B) - RS485
- ④ RTS
- ⑤ M5V
- ⑥ P5V
- ⑦ TxD-N (line A) - RS422
- ⑧ RxD-N (line A) RS422
RxD/TxD-N (line A) - RS485
- ⑨ n.c.

X2 MPI(PB)

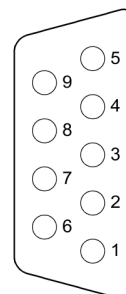

- ① n. c.
- ② n. c.
- ③ RxD/TxD-P (line B)
- ④ RTS
- ⑤ M5V
- ⑥ P5V
- ⑦ n. c.
- ⑧ RxD/TxD-N (line A)
- ⑨ n.c.



Please note that the interface X2 MPI(PB) does not provide DC 24V, which is necessary for some programming adapters!

X1 PtP (RS422/485)

9pin SubD jack (isolated):

Using the *PtP* functionality the RS485 interface is allowed to connect via serial point to point connection to different source res. target systems.

- Protocols:
 - ASCII
 - STX/ETX
 - 3964R
 - USS
 - Modbus master (ASCII, RTU)
- Serial bus connection
 - Full-duplex Four-wire operation (RS422)
 - Half-duplex Two-wire operation (RS485)
 - Data transfer rate: max. 115 kBaud

🔗 *Chap. 8 'Option: PtP communication' page 202*

Option: Extension module EM M09 2x serial interface

X2 MPI(PB)

9pin SubD jack (isolated):

The interface supports the following functions, which are switch able:

- MPI (default / after overall reset)
The MPI interface serves for the connection between programming unit and CPU. By means of this the project engineering and programming happens. In addition MPI serves for communication between several CPUs or between HMIs and CPU. Standard setting is MPI address 2.
- PROFIBUS DP slave (optional)
The PROFIBUS slave functionality of this interface can be activated by configuring the sub module 'MPI/DP' of the CPU in the hardware configuration. ↪ Chap. 9 'Option: Deployment PROFIBUS communication' page 216



To switch the interface X2 MPI(PB) to PROFIBUS functionality you have to activate the according bus functionality by means of a VSC storage media from VIPA. By plugging the VSC storage card and then an overall reset the according functionality is activated. ↪ Chap. 4.15 'Deployment storage media - VSD, VSC' page 98

LEDs



X1 PtP TxD	Description
<input checked="" type="checkbox"/> green flickers	Send activity
<input type="checkbox"/>	No send activity
X2 MPI(PB) DE	Description
<input checked="" type="checkbox"/> green	<ul style="list-style-type: none"> ■ Power supply Expansion module EM M09 available ■ Slave is in DE (data exchange) ■ Slave exchanges data with the master ■ Slave is in RUN state
<input checked="" type="checkbox"/> green flashes	<ul style="list-style-type: none"> ■ LED flashes at PowerON of EM M09
<input type="checkbox"/>	<ul style="list-style-type: none"> ■ No power supply EM M09 available ■ Slave has no configuration

3.4 Technical data

3.4.1 Technical data CPU

Order no.	M13-CCF0000
Type	CPU M13C
Module ID	-
Technical data power supply	
Power supply (rated value)	DC 24 V
Power supply (permitted range)	DC 20.4...28.8 V
Reverse polarity protection	✓
Current consumption (no-load operation)	120 mA
Current consumption (rated value)	360 mA
Inrush current	3 A
I^2t	0.1 A ² s
Max. current drain at backplane bus	1 A
Max. current drain load supply	-
Power loss	7 W
Technical data digital inputs	
Number of inputs	16
Cable length, shielded	1000 m
Cable length, unshielded	600 m
Rated load voltage	DC 24 V
Reverse polarity protection of rated load voltage	✓
Current consumption from load voltage L+ (without load)	25 mA
Rated value	DC 24 V
Input voltage for signal "0"	DC 0...5 V
Input voltage for signal "1"	DC 15...28.8 V
Input voltage hysteresis	-
Signal logic input	Sinking input
Frequency range	-
Input resistance	-
Input current for signal "1"	3 mA
Connection of Two-Wire-BEROs possible	✓
Max. permissible BERO quiescent current	0.5 mA
Input delay of "0" to "1"	3 μ s – 15 ms / 0.5 ms – 15 ms
Input delay of "1" to "0"	3 μ s – 15 ms / 0.5 ms – 15 ms
Number of simultaneously utilizable inputs horizontal configuration	16

Technical data > Technical data CPU

Order no.	M13-CCF0000
Number of simultaneously utilizable inputs vertical configuration	16
Input characteristic curve	IEC 61131-2, type 1
Initial data size	16 Bit
Technical data digital outputs	
Number of outputs	12
Cable length, shielded	1000 m
Cable length, unshielded	600 m
Rated load voltage	DC 24 V
Reverse polarity protection of rated load voltage	✓
Current consumption from load voltage L+ (without load)	20 mA
Total current per group, horizontal configuration, 40°C	6 A
Total current per group, horizontal configuration, 60°C	6 A
Total current per group, vertical configuration	6 A
Output voltage signal "1" at min. current	L+ (-0.8 V)
Output voltage signal "1" at max. current	L+ (-0.8 V)
Output current at signal "1", rated value	0.5 A
Signal logic output	Sinking output
Output current, permitted range to 40°C	5 mA to 0.6 A
Output current, permitted range to 60°C	5 mA to 0.6 A
Output current at signal "0" max. (residual current)	0.5 mA
Output delay of "0" to "1"	2 µs / 30 µs
Output delay of "1" to "0"	3 µs / 175 µs
Minimum load current	-
Lamp load	10 W
Parallel switching of outputs for redundant control of a load	not possible
Parallel switching of outputs for increased power	not possible
Actuation of digital input	✓
Switching frequency with resistive load	max. 1000 Hz
Switching frequency with inductive load	max. 0.5 Hz
Switching frequency on lamp load	max. 10 Hz
Internal limitation of inductive shut-off voltage	L+ (-45 V)
Short-circuit protection of output	yes, electronic
Trigger level	1 A
Number of operating cycle of relay outputs	-
Switching capacity of contacts	-

Order no.	M13-CCF0000
Output data size	12 Bit
Technical data analog inputs	
Number of inputs	2
Cable length, shielded	200 m
Rated load voltage	-
Reverse polarity protection of rated load voltage	-
Current consumption from load voltage L+ (without load)	-
Voltage inputs	✓
Min. input resistance (voltage range)	100 kΩ
Input voltage ranges	0 V ... +10 V
Operational limit of voltage ranges	+/-3.5%
Operational limit of voltage ranges with SFU	-
Basic error limit voltage ranges	+/-3.0%
Basic error limit voltage ranges with SFU	-
Destruction limit voltage	max. 30V
Current inputs	-
Max. input resistance (current range)	-
Input current ranges	-
Operational limit of current ranges	-
Operational limit of current ranges with SFU	-
Basic error limit current ranges	-
Radical error limit current ranges with SFU	-
Destruction limit current inputs (electrical current)	-
Destruction limit current inputs (voltage)	-
Resistance inputs	-
Resistance ranges	-
Operational limit of resistor ranges	-
Operational limit of resistor ranges with SFU	-
Basic error limit	-
Basic error limit with SFU	-
Destruction limit resistance inputs	-
Resistance thermometer inputs	-
Resistance thermometer ranges	-
Operational limit of resistance thermometer ranges	-
Operational limit of resistance thermometer ranges with SFU	-

Technical data > Technical data CPU

Order no.	M13-CCF0000
Basic error limit thermoresistor ranges	-
Basic error limit thermoresistor ranges with SFU	-
Destruction limit resistance thermometer inputs	-
Thermocouple inputs	-
Thermocouple ranges	-
Operational limit of thermocouple ranges	-
Operational limit of thermocouple ranges with SFU	-
Basic error limit thermoelement ranges	-
Basic error limit thermoelement ranges with SFU	-
Destruction limit thermocouple inputs	-
Programmable temperature compensation	-
External temperature compensation	-
Internal temperature compensation	-
Technical unit of temperature measurement	-
Resolution in bit	12
Measurement principle	successive approximation
Basic conversion time	2 ms
Noise suppression for frequency	40 dB
Initial data size	4 Byte
Technical data analog outputs	
Number of outputs	-
Cable length, shielded	-
Rated load voltage	-
Reverse polarity protection of rated load voltage	-
Current consumption from load voltage L+ (without load)	-
Voltage output short-circuit protection	-
Voltage outputs	-
Min. load resistance (voltage range)	-
Max. capacitive load (current range)	-
Max. inductive load (current range)	-
Output voltage ranges	-
Operational limit of voltage ranges	-
Basic error limit voltage ranges with SFU	-
Destruction limit against external applied voltage	-
Current outputs	-
Max. in load resistance (current range)	-

Order no.	M13-CCF0000
Max. inductive load (current range)	-
Typ. open circuit voltage current output	-
Output current ranges	-
Operational limit of current ranges	-
Radical error limit current ranges with SFU	-
Destruction limit against external applied voltage	-
Settling time for ohmic load	-
Settling time for capacitive load	-
Settling time for inductive load	-
Resolution in bit	-
Conversion time	-
Substitute value can be applied	-
Output data size	-
Technical data counters	
Number of counters	4
Counter width	32 Bit
Maximum input frequency	100 kHz
Maximum count frequency	400 kHz
Mode incremental encoder	✓
Mode pulse / direction	✓
Mode pulse	✓
Mode frequency counter	✓
Mode period measurement	✓
Gate input available	✓
Latch input available	✓
Reset input available	-
Counter output available	✓
Load and working memory	
Load memory, integrated	128 KB
Load memory, maximum	128 KB
Work memory, integrated	64 KB
Work memory, maximal	128 KB
Memory divided in 50% program / 50% data	✓
Memory card slot	SD/MMC-Card with max. 2 GB
Hardware configuration	
Racks, max.	1

Technical data > Technical data CPU

Order no.	M13-CCF0000
Modules per rack, max.	8
Number of integrated DP master	-
Number of DP master via CP	-
Operable function modules	-
Operable communication modules PtP	-
Operable communication modules LAN	-
Status information, alarms, diagnostics	
Status display	yes
Interrupts	yes, parameterizable
Process alarm	yes, parameterizable
Diagnostic interrupt	yes, parameterizable
Diagnostic functions	yes, parameterizable
Diagnostics information read-out	possible
Supply voltage display	green LED
Group error display	red LED
Channel error display	red LED per group
Isolation	
Between channels	✓
Between channels of groups to	16
Between channels and backplane bus	✓
Between channels and power supply	-
Max. potential difference between circuits	DC 75 V/ AC 50 V
Max. potential difference between inputs (U _{cm})	-
Max. potential difference between Mana and Mintern (U _{iso})	-
Max. potential difference between inputs and Mana (U _{cm})	-
Max. potential difference between inputs and Mintern (U _{iso})	-
Max. potential difference between Mintern and outputs	-
Insulation tested with	DC 500 V
Command processing times	
Bit instructions, min.	0.02 µs
Word instruction, min.	0.02 µs
Double integer arithmetic, min.	0.02 µs
Floating-point arithmetic, min.	0.12 µs
Timers/Counters and their retentive characteristics	
Number of S7 counters	512

Order no.	M13-CCF0000
S7 counter remanence	adjustable 0 up to 256
S7 counter remanence adjustable	C0 .. C7
Number of S7 times	512
S7 times remanence	adjustable 0 up to 256
S7 times remanence adjustable	not retentive
Data range and retentive characteristic	
Number of flags	8192 Byte
Bit memories retentive characteristic adjustable	adjustable 0 up to 256
Bit memories retentive characteristic preset	MB0 .. MB15
Number of data blocks	1024
Max. data blocks size	64 KB
Max. local data size per execution level	4096 Byte
Blocks	
Number of OBs	22
Number of FBs	1024
Number of FCs	1024
Maximum nesting depth per priority class	16
Maximum nesting depth additional within an error OB	4
Time	
Real-time clock buffered	✓
Clock buffered period (min.)	30 d
Accuracy (max. deviation per day)	10 s
Number of operating hours counter	8
Clock synchronization	✓
Synchronization via MPI	Master/Slave
Synchronization via Ethernet (NTP)	no
Address areas (I/O)	
Input I/O address area	2048 Byte
Output I/O address area	2048 Byte
Input process image maximal	2048 Byte
Output process image maximal	2048 Byte
Digital inputs	144
Digital outputs	140
Digital inputs central	144
Digital outputs central	140
Integrated digital inputs	16

Technical data > Technical data CPU

Order no.	M13-CCF0000
Integrated digital outputs	12
Analog inputs	2
Analog outputs	0
Analog inputs, central	2
Analog outputs, central	0
Integrated analog inputs	2
Integrated analog outputs	0
Communication functions	
PG/OP channel	✓
Global data communication	✓
Number of GD circuits, max.	8
Size of GD packets, max.	54 Byte
S7 basic communication	✓
S7 basic communication, user data per job	76 Byte
S7 communication	✓
S7 communication as server	✓
S7 communication as client	-
S7 communication, user data per job	160 Byte
Number of connections, max.	32
PWM data	
PWM channels	2
PWM time basis	1 µs / 0.1 ms / 1 ms
Period length	-
Minimum pulse width	0...0.5 * Period duration
Type of output	Highside
Functionality Sub-D interfaces	
Type	X1
Type of interface	RS422/485 isolated
Connector	Sub-D, 9-pin, female
Electrically isolated	✓
MPI	-
MP ² I (MPI/RS232)	-
DP master	-
DP slave	-
Point-to-point interface	✓
5V DC Power supply	max. 90mA, isolated

Order no.	M13-CCF0000
24V DC Power supply	-
Type	X2
Type of interface	RS485 isolated
Connector	Sub-D, 9-pin, female
Electrically isolated	✓
MPI	✓
MP ² I (MPI/RS232)	-
DP master	-
DP slave	optional
Point-to-point interface	-
5V DC Power supply	max. 90mA, isolated
24V DC Power supply	-
Functionality MPI	
Number of connections, max.	32
PG/OP channel	✓
Routing	✓
Global data communication	✓
S7 basic communication	✓
S7 communication	✓
S7 communication as server	✓
S7 communication as client	-
Transmission speed, min.	19.2 kbit/s
Transmission speed, max.	12 Mbit/s
Functionality PROFIBUS slave	
Number of connections, max.	32
PG/OP channel	✓
Routing	✓
S7 communication	✓
S7 communication as server	✓
S7 communication as client	-
Direct data exchange (slave-to-slave communication)	-
DPV1	✓
Transmission speed, min.	9.6 kbit/s
Transmission speed, max.	12 Mbit/s
Automatic detection of transmission speed	✓

Technical data > Technical data CPU

Order no.	M13-CCF0000
Transfer memory inputs, max.	244 Byte
Transfer memory outputs, max.	244 Byte
Address areas, max.	32
User data per address area, max.	32 Byte
Functionality RJ45 interfaces	
Type	X3/X4
Type of interface	Ethernet 10/100 MBit Switch
Connector	2 x RJ45
Electrically isolated	✓
PG/OP channel	✓
Number of connections, max.	4
Productive connections	✓
Fieldbus	-
Type	-
Type of interface	-
Connector	-
Electrically isolated	-
PG/OP channel	-
Number of connections, max.	-
Productive connections	-
Fieldbus	-
Point-to-point communication	
PtP communication	✓
Interface isolated	✓
RS232 interface	-
RS422 interface	✓
RS485 interface	✓
Connector	Sub-D, 9-pin, female
Transmission speed, min.	1200 bit/s
Transmission speed, max.	115.2 kbit/s
Cable length, max.	500 m
Point-to-point protocol	
ASCII protocol	✓
STX/ETX protocol	✓
3964(R) protocol	✓

Order no.	M13-CCF0000
RK512 protocol	-
USS master protocol	✓
Modbus master protocol	✓
Modbus slave protocol	✓
Special protocols	-
Properties PROFINET I/O-Controller via PG/OP	
Realtime Class	-
Conformance Class	PROFINET IO
Number of PN IO devices	8
IRT support	-
Shared Device supported	✓
MRP Client supported	✓
Prioritized start-up	-
Number of PN IO lines	1
Address range inputs, max.	2 KB
Address range outputs, max.	2 KB
Transmitting clock	1 ms
Update time	1 ms .. 512 ms
Isochronous mode	-
Parallel operation as controller and I-Device	✓
Properties PROFINET I/O controller	
Realtime Class	-
Conformance Class	-
Number of PN IO devices	-
IRT support	-
Prioritized start-up	-
Number of PN IO lines	-
Address range inputs, max.	-
Address range outputs, max.	-
Transmitting clock	-
Update time	-
Isochronous mode	-
Properties PROFINET I-Device via PG/OP	
I/O Data range, max.	768 Byte
Update time	1 ms .. 512 ms
Mode as Shared I-Device	-

Technical data > Technical data CPU

Order no.	M13-CCF0000
Management & diagnosis via PG/OP	
Protocols	ICMP DCP LLDP / SNMP NTP
Web based diagnosis	✓
NCM diagnosis	-
Ethernet communication via PG/OP	
Number of productive connections via PG/OP, max.	2
Number of productive connections by Siemens NetPro, max.	2
S7 connections	BSEND, BRCV, GET, PUT, Connection of active and passive data handling
User data per S7 connection, max.	64 KB
TCP-connections	FETCH PASSIV, WRITE PASSIV, Connection of passive data handling
User data per TCP connection, max.	8 KB
ISO on TCP connections (RFC 1006)	FETCH PASSIV, WRITE PASSIV, Connection of passive data handling
User data per ISO connection, max.	8 KB
Ethernet open communication via PG/OP	
Number of configurable connections, max.	2
ISO on TCP connections (RFC 1006)	TSEND, TRCV, TCON, TDISCON
User data per ISO on TCP connection, max.	32 KB
TCP-Connections native	TSEND, TRCV, TCON, TDISCON
User data per native TCP connection, max.	32 KB
User data per ad hoc TCP connection, max.	1460 Byte
UDP-connections	TUSEND, TURCV
User data per UDP connection, max.	1472 Byte
WebVisu via PG/OP	
WebVisu is supported	✓
Max. number of connections WebVisu	4
WebVisu supports HTTP	✓
WebVisu supports HTTPS	✓
Housing	
Material	PPE / PPE GF10
Mounting	Profile rail 35 mm
Mechanical data	

Order no.	M13-CCF0000
Dimensions (WxHxD)	72 mm x 88 mm x 71 mm
Net weight	230 g
Weight including accessories	230 g
Gross weight	250 g
Environmental conditions	
Operating temperature	0 °C to 60 °C
Storage temperature	-25 °C to 70 °C
Certifications	
UL certification	in preparation
KC certification	in preparation

Technical data > Technical data EM M09

3.4.2 Technical data EM M09

Order no.	M09-0CB00
Type	Micro Extension 2xRS485
Module ID	-
Status information, alarms, diagnostics	
Status display	green LED
Interrupts	no
Process alarm	no
Diagnostic interrupt	no
Diagnostic functions	no
Diagnostics information read-out	-
Supply voltage display	none
Group error display	-
Channel error display	-
Housing	
Material	PPE / PPE GF10
Mounting	Profile rail 35 mm
Mechanical data	
Dimensions (WxHxD)	35 mm x 88 mm x 26 mm
Net weight	56 g
Weight including accessories	56 g
Gross weight	66 g
Environmental conditions	
Operating temperature	0 °C to 60 °C
Storage temperature	-25 °C to 70 °C
Certifications	
UL certification	in preparation
KC certification	in preparation

4 Deployment CPU M13-CCF0000

4.1 Assembly



Information about assembly and cabling ↗ Chap. 2 'Basics and mounting' page 11.

4.2 Start-up behavior

Turn on power supply

- The CPU checks whether a project AUTOLOAD.WLD exists on the memory card. If so, an overall reset is executed and the project is automatically loaded from the memory card.
- The CPU checks whether a command file with the name VIPA_CMD.MMC exists on the memory card. If so the command file is loaded from the memory card and the commands are executed.
- After PowerON and CPU STOP the CPU checks if there is a *.pkb file (firmware file) on the memory card. If so, this is shown by the status bar of the CPU and the firmware may be installed by an update request. ↗ Chap. 4.13 'Firmware update' page 96
- The CPU checks if a previously activated VSC is inserted. If not, this is shown by the status bar of the CPU and a diagnostics entry is released. The CPU switches to STOP after 72 hours. With a just installed VSC activated functionalities remain activated. ↗ Chap. 4.19 'Diagnostic entries' page 105

After this the CPU switches to the operating mode, which is set on the operating mode switch.

Delivery state

In the delivery state the CPU is overall reset. After a STOP→RUN transition the CPU switches to RUN without program.

4.3 Addressing

4.3.1 Overview

To provide specific addressing of the installed peripheral modules, certain addresses must be allocated in the CPU. This address mapping is in the CPU as hardware configuration. If there is no hardware configuration, depending on the slot, the CPU assigns automatically peripheral addresses for digital in-/output modules starting with 0 and analog modules are assigned to even addresses starting with 256.

4.3.2 Default address assignment of the I/O part

Sub module	Input address	Access	Assignment
AI5/AO2	800	WORD	Analog input channel 0 (X6)
	802	WORD	Analog input channel 1 (X6)

Sub module	Input address	Access	Description
DI24/DO16	136	BYTE	Digital input I+0.0 ... I+0.7 (X1)
	137	BYTE	Digital input I+1.0 ... I+1.7 (X5)

Sub module	Input address	Access	Description
Counter	816	DINT	Channel 0: Counter value / Frequency value
	820	DINT	Channel 1: Counter value / Frequency value
	824	DINT	Channel 2: Counter value / Frequency value
	828	DINT	Channel 3: Counter value / Frequency value

Sub module	Output address	Access	Description
DI24/DO16	136	BYTE	Digital output Q+0.0 ... Q+0.7 (X2)
	137	BYTE	Digital output Q+1.0 ... Q+1.3 (X6)

Sub module	Output address	Access	Description
Counter	816	DWORD	reserved
	820	DWORD	reserved
	824	DWORD	reserved
	828	DWORD	reserved

4.3.3 Option: Addressing peripheral modules

The CPU M13-CCF0000 provides an I/O area (address 0 ... 2047) and a process image of the in- and outputs (each address default 0 ... 127). The size of the process image can be preset via the parameterization. ↪ *Chap. 4.7 'Setting standard CPU parameters' page 76*

The process image is updated automatically when a cycle has been completed. The process image is divided into two parts:

- process image to the inputs (PII)
- process image to the outputs (PIQ)

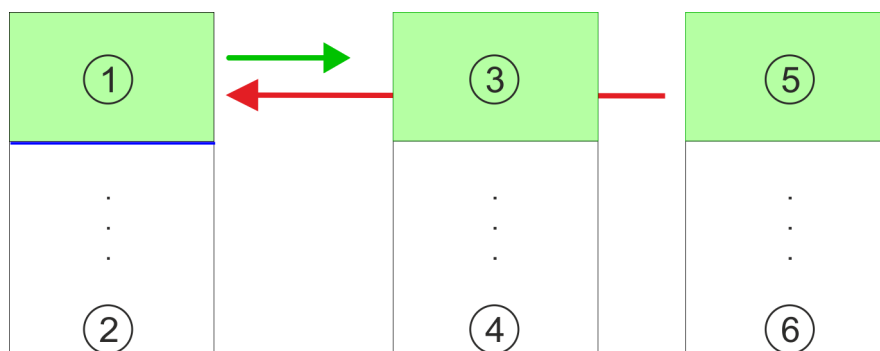

- 1 I/O area: 0 ... 127 (default)
- 2 I/O area: 0 ... 2047
- 3 Process image of the inputs (PII): 0 ... 127
- 4 Process image of the inputs (PII) max.: 2047
- 5 Process image of the outputs (PIQ): 0 ... 127
- 6 Process image of the outputs (PIQ) max.: 2047

Max. number of pluggable modules

Up to 8 peripheral modules can be connected to the CPU.

Define addresses by hardware configuration

You may access the modules with read res. write accesses to the peripheral bytes or the process image. To define addresses a hardware configuration may be used. For this, click on the properties of the according module and set the wanted address.

Automatic addressing

If you do not like to use a hardware configuration, an automatic addressing is established. Here the address assignment follows the following specifications:

- Starting with slot 1, the central plugged modules are assigned with ascending logical addresses.
- The length of the memory area corresponds to the size of the process data of the according module. Information about the sizes of the process data can be found in the according manual of the module.
- The memory areas of the modules are assigned without gaps separately for input and output area.
- Digital modules are mapped starting at address 0 and all other modules are mapped starting from address 256.
- As soon as the mapping of digital modules exceeds the address 256, by regarding the order, these are mapped starting from address 256.

4.4 Hardware configuration - CPU

Precondition

- The configuration of the CPU takes place at the *'hardware configurator'* of the Siemens SIMATIC Manager V 5.5 SP2 and up.
- The configuration of the System MICRO CPU happens by means of a virtual PROFINET IO device *'VIPA MICRO PLC'*. The *'VIPA MICRO PLC'* is to be installed in the hardware catalog by means of the GSDML.



For project engineering a thorough knowledge of the Siemens SIMATIC Manager and the Siemens hardware configurator is required!

Installing the IO device VIPA MICRO PLC

The installation of the PROFINET IO devices *'VIPA MICRO PLC'* happens in the hardware catalog with the following approach:

1. ➤ Go to the service area of www.vipa.com.
2. ➤ Load from the download area at *'Config files → PROFINET'* the according file for your System MICRO.
3. ➤ Extract the file into your working directory.
4. ➤ Start the Siemens hardware configurator.
5. ➤ Close all the projects.
6. ➤ Select *'Options → Install new GSD file'*
7. ➤ Navigate to your working directory and install the according GSDML file.
 - ⇒ After the installation according PROFINET IO device can be found at *'PROFINET IO → Additional field devices → I/O → VIPA Micro System'*

Proceeding

In the Siemens SIMATIC Manager the following steps should be executed:

1. ➤ Start the Siemens hardware configurator with a new project.
2. ➤ Insert a profile rail from the hardware catalog.
3. ➤ Place at *'Slot'* number 2 the CPU 314C-2 PN/DP (314-6EH04-0AB0 V3.3).

Slot	Module
1	
2	CPU 314C-2PN/DP
X1	MPI/DP
X2	PN-IO
X2...	Port 1
X2...	Port 2
...	...
3	

4. ➤ Click at the sub module *'PN-IO'* of the CPU.
5. ➤ Select *'Context menu → Insert PROFINET IO System'*.

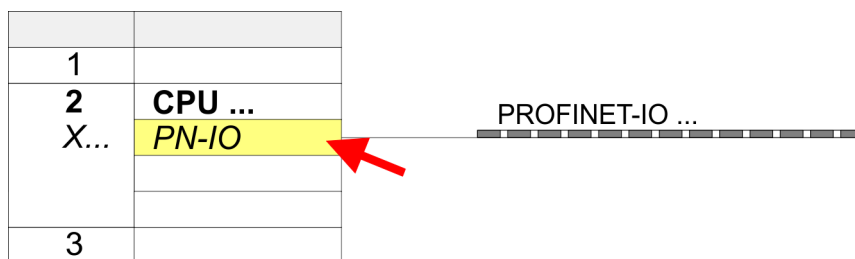

- 6. Use [New] to create a new subnet and assign valid IP address data for your PROFINET system.

i With firmware version V. 2.4 and up, you can access the Ethernet PG/OP channel via this IP address data. The configuration via an additional CP is no longer required, but still possible. ↪ Chap. 4.6 'Hardware configuration - Ethernet PG/OP channel' page 71

- 7. Click at the sub module 'PN-IO' of the CPU and open with 'Context menu → Properties' the properties dialog.
- 8. Enter at 'General' a 'Device name'. The device name must be unique at the Ethernet subnet.

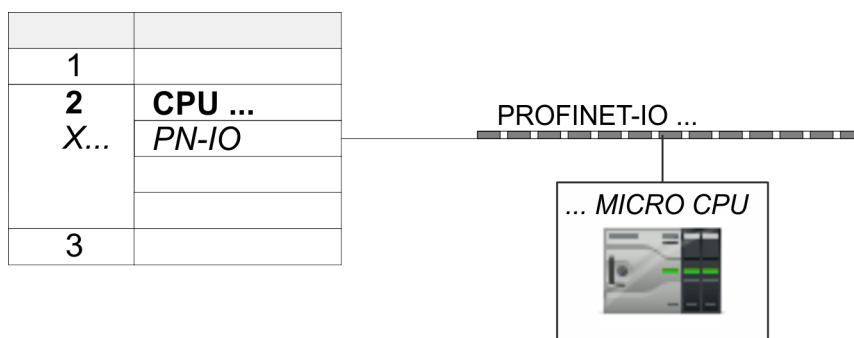

0	... MICRO CPU ...	M13-CCF0000	
X2	M13-CCF0000		
1			
2			
3			
...			

- 9. Navigate in the hardware catalog to the directory 'PROFINET IO → Additional field devices → I/O → VIPA Micro System' and connect the IO device M13-CCF0000 to your PROFINET system.
 - ⇒ In the slot overview of the PROFINET IO device 'VIPA MICRO PLC' the CPU is already placed at slot 0.

4.5 Hardware configuration - System MICRO modules

System MICRO backplane bus

To connect System MICRO modules, the CPU has a backplane bus, which is supplied by the CPU. Here up to 8 System MICRO modules can be connected.

Proceeding

1. ➤ Perform, if not already done, a hardware configuration for the CPU. ↪ *Chap. 4.4 'Hardware configuration - CPU' page 68*
2. ➤ Starting with slot 1 place in the slot overview of the PROFINET IO device 'VIPA MICRO PLC' your System MICRO modules in the plugged sequence.
3. ➤ Parameterize if necessary the modules and assign valid addresses, so that they can directly be addressed.

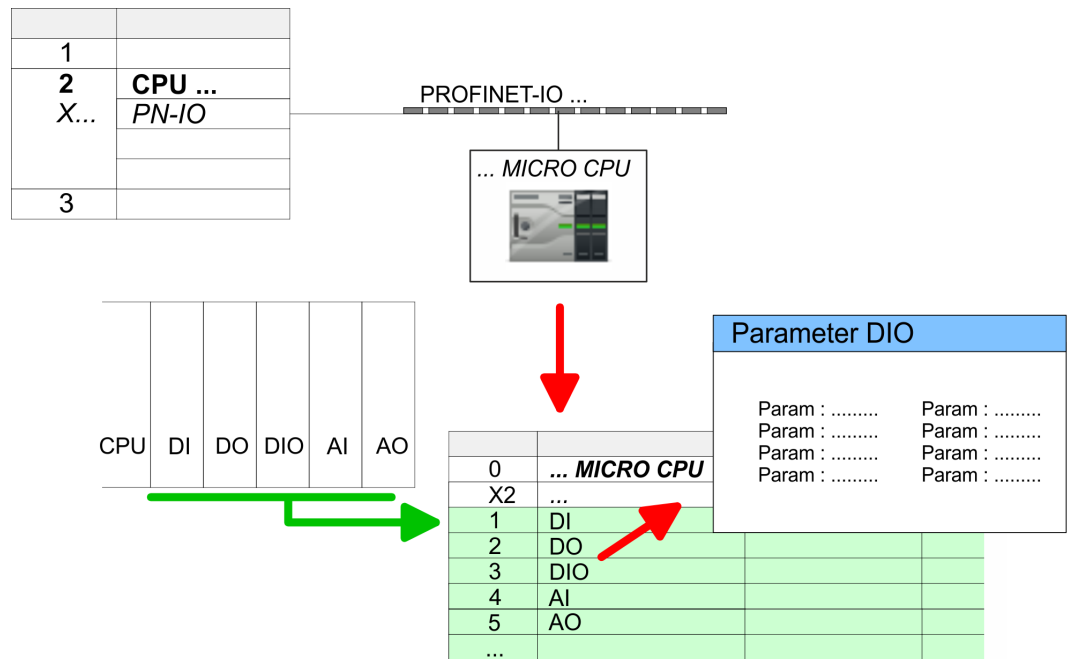

4.6 Hardware configuration - Ethernet PG/OP channel

Overview

The CPU has an integrated Ethernet PG/OP channel. This channel allows you to program and remote control your CPU.

- The Ethernet PG/OP channel (X3/X4) is designed as switch. This enables PG/OP communication via the connections X3 and X4.
- Configurable connections are possible.
- DHCP respectively the assignment of the network configuration with a DHCP server is supported.
- Default diagnostics addresses: 2025 ... 2040
- At the first commissioning respectively after a factory reset the Ethernet PG/OP channel has no IP address. For online access to the CPU via the Ethernet PG/OP channel, valid IP address parameters have to be assigned to this by means of your configuration tool. This is called "initialization".
- Via the Ethernet PG/OP channel, you have access to:
 - Device website, where you can find information on firmware status, connected peripherals, current cycle times, etc.
 - *WebVisu* project, which is to be created in the *SPEED7 Studio*.
 - PROFINET IO controller or the PROFINET I-Device.

Assembly and commissioning

1. ➔ Install your System with your CPU.
2. ➔ Wire the system by connecting cables for voltage supply and signals.
3. ➔ Connect the one of the Ethernet jack (X3, X4) of the Ethernet PG/OP channel to Ethernet, to which your programming device (PC) is connected.
4. ➔ Switch on the power supply.
 - ⇒ After a short boot time the CPU is ready for communication. It possibly has no IP address data and requires an initialization.

"Initialization" via PLC functions

The initialization via PLC functions takes place with the following proceeding:

- ➔ Determine the current Ethernet (MAC) address of your Ethernet PG/OP channel. This can be found at the front of your CPU with the name "MAC PG/OP: ...".

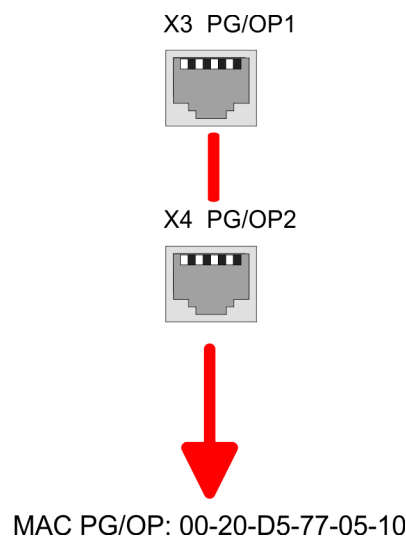

Assign IP address parameters

You get valid IP address parameters from your system administrator. The assignment of the IP address data happens online in the Siemens SIMATIC Manager starting with version V 5.5 & SP2 with the following proceeding:

1. ➤ Start the Siemens SIMATIC Manager and set via 'Options' ➔ 'Set PG/PC interface' the access path to 'TCP/IP -> Network card ...'.
 2. ➤ Open with 'PLC ➔ Edit Ethernet Node n' the dialog window with the same name.
 3. ➤ To get the stations and their MAC address, use the [Browse] button or type in the MAC Address. The Mac address may be found at the 1. label beneath the front flap of the CPU.
 4. ➤ Choose if necessary the known MAC address of the list of found stations.
 5. ➤ Either type in the IP configuration like IP address, subnet mask and gateway.
 6. ➤ Confirm with [Assign IP configuration].
- ⇒ Direct after the assignment the Ethernet PG/OP channel may be reached online by these address data. The value remains as long as it is reassigned, it is overwritten by a hardware configuration or an factory reset is executed.

4.6.1 Take IP address parameters in project**2 variants for configuration**

From firmware version V. 2.4 and up, you have the following options for configuring the Ethernet PG/OP channel:

- Configuration via integrated CPU interface (firmware version V. 2.4 and up only).
- Configuration via additional CP (all firmware versions).

4.6.1.1 Configuration via integrated CPU interface**Proceeding**

From firmware version V. 2.4 this variant for configuration is recommended. The following advantages result:

- The configuration becomes clearer, because the periphery modules and the PROFINET IO devices are configured on the PROFINET line of the CPU and no additional CP is to be configured.
- There are no address collisions, because the S7 addresses for all components are assigned from the address area of the CPU.

Unless during the hardware configuration of the CPU  68 there was no IP address data assigned yet or these are to be changed, the configuration happens to the following proceeding, otherwise the Ethernet PG/OP channel is configured.

1. ➤ Open the Siemens hardware configurator and, if not already done, configure the Siemens CPU 314C-2 PN/DP (314-6EH04-0AB0 V3.3).
2. ➤ Open the PROFINET Properties dialog box of the CPU by double-clicking 'PN-IO'.

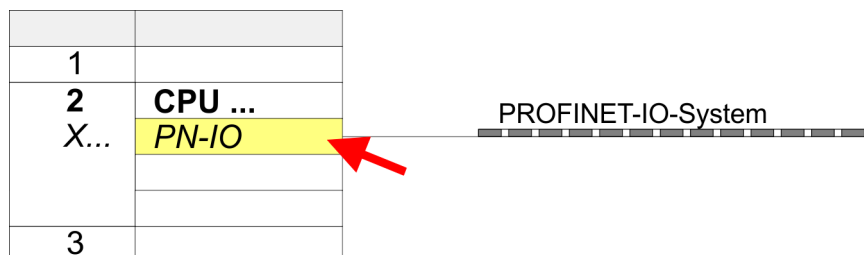

3. ➤ Click at 'General'.
4. ➤ At 'Properties', enter the previously assigned IP address data and a subnet. The IP address data are not accepted without subnet assignment!

5. Transfer your project.

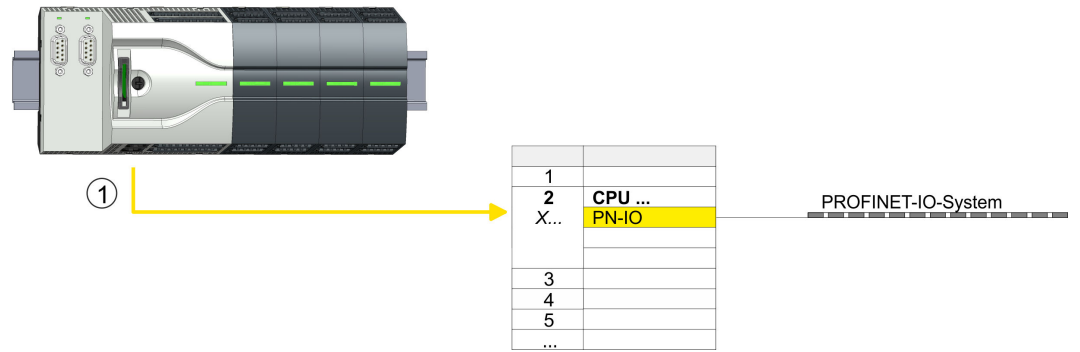

1 Ethernet PG/OP channel

4.6.1.1.1 Time-of-day synchronization

NTP method

In the NTP mode (**N**etwork **T**ime **P**rotocol) the module sends as client time-of-day queries at regular intervals to all configured NTP servers within the sub net. You can define up to 4 NTP server. Based on the response from the servers, the most reliable and most exact time-of-day is determined. Here the time with the lowest *stratum* is used. *Stratum 0* is the time standard (atomic clock). *Stratum 1* are directly linked to this NTP server. Using the NTP method, clocks can be synchronized over subnet boundaries. The configuration of the NTP servers is carried out in the Siemens SIMATIC Manager via the CP, which is already configured.

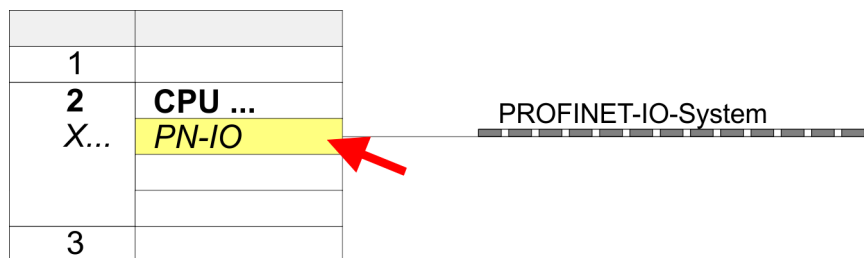

1. Open the Properties dialog by double-clicking 'PN-IO'.
2. Select the tab 'Time-of-day synchronization'.
3. Activate the NTP method by enabling 'Activate NTP time-of-day synchronization'.
4. Click at [Add] and add the corresponding NTP server.
5. Set the 'Update interval' you want. Within this interval, the time of the module is synchronized once.
6. Close the dialog with [OK].
7. Save and transfer your project to the CPU.
 - ⇒ After transmission, the NTP time is requested by each configured time server and the best response for the time synchronization is used.



Please note that although the time zone is evaluated, an automatic changeover from winter to summer time is not supported. Industrial systems with time-of-day synchronization should always be set in accordance to the winter time.

With the FC 61 you can determine the local time in the CPU. More information about the usage of this block may be found in the manual "SPEED7 Operation List" from VIPA.

4.6.1.2 Configuration via additional CP

Proceeding

This is the conventional variant for configuration and is supported by all firmware versions. If possible, always use the configuration via the internal interface, otherwise the following disadvantages result:

- Address overlaps are not recognized in the Siemens SIMATIC Manager.
- For PROFINET devices only the address range 0 ... 1023 is available.
- The addresses of the PROFINET devices are not checked with the address range of the CPU by the Siemens SIMATIC Manager for address overlaps.

The configuration happens according to the following procedure:

1. ➤ Open the Siemens hardware configurator and, if not already done, configure the Siemens CPU 314C-2 PN/DP (314-6EH04-0AB0 V3.3).
2. ➤ Place for the Ethernet PG/OP channel at slot 4 the Siemens CP 343-1 (SIMATIC 300 \ CP 300 \ Industrial Ethernet \ CP 343-1 \ 6GK7 343-1EX30 0XE0 V3.0).



CAUTION!

Please configure the diagnostic addresses of the CP343-1EX30 for 'PN-IO', 'Port1' and 'Port2' so that no overlaps occur in the periphery input area. Otherwise your CPU can not start-up and you receive the diagnostic entry 0xE904. These addresses overlaps are not recognized by the Siemens SIMATIC Manager.

3. ➤ Open the Properties dialog by double-clicking on 'PN-IO' of the CP 343-1EX30 and enter the previously assigned IP address data and a subnet for the CP at 'Properties'. The IP address data are not accepted without subnet assignment!
4. ➤ Transfer your project.

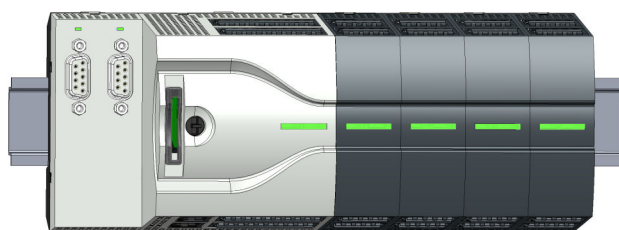

1	
2	CPU ...
X...	
3	
4	343-1EX30
...	
...	

1 Ethernet PG/OP channel

4.6.1.2.1 Time-of-day synchronization

NTP method

In the NTP mode (Network Time Protocol) the module sends as client time-of-day queries at regular intervals to all configured NTP servers within the sub net. You can define up to 4 NTP server. Based on the response from the servers, the most reliable and most exact time-of-day is determined. Here the time with the lowest *stratum* is used. *Stratum 0* is the time standard (atomic clock). *Stratum 1* are directly linked to this NTP server. Using the NTP method, clocks can be synchronized over subnet boundaries. The configuration of the NTP servers is carried out in the Siemens SIMATIC Manager via the CP, which is already configured.

1	
2	CPU 31...
X...	
3	
4	343-1EX30
...	
...	

1. Open the properties dialog via double-click on the CP 343-1EX30.
2. Select the tab 'Time-of-day synchronization'.
3. Activate the NTP method by enabling 'Activate NTP time-of-day synchronization'.
4. Click at [Add] and add the corresponding NTP server.
5. Select your 'Time zone'. In the NTP method, UTC (Universal Time Coordinated) is generally transmitted; this corresponds to GMT (Greenwich Mean Time). By configuring the local time zone, you can set a time offset to UTC.
6. Set the 'Update interval' you want. Within this interval, the time of the module is synchronized once.
7. Close the dialog with [OK].
8. Save and transfer your project to the CPU.
 - ⇒ After transmission, the NTP time is requested by each configured time server and the best response for the time synchronization is used.



Please note that although the time zone is evaluated, an automatic changeover from winter to summer time is not supported. Industrial systems with time-of-day synchronization should always be set in accordance to the winter time.

With the FC 61 you can determine the local time in the CPU. More information about the usage of this block may be found in the manual "SPEED7 Operation List" from VIPA.

4.7 Setting standard CPU parameters

4.7.1 Parameterization via Siemens CPU

Parametrization via Siemens CPU 314-6EH04

Since the CPU from VIPA is to be configured as Siemens CPU 314C-2 PN/DP (314-6EH04-0AB0 V3.3) in the Siemens hardware configurator, the standard parameters of the VIPA CPU may be set with "Object properties" of the CPU 314C-2 PN/DP during hardware configuration. Via a double-click on the CPU 314C-2 PN/DP the parameter window of the CPU may be accessed. Using the registers you get access to every standard parameter of the CPU.

1	
2	CPU ...
X1	MPI/DP
X2	PN-IO
X2 P1	Port 1
3	



Parameter CPU	
Param :	Param :
Param :	Param :
Param :	Param :
Param :	Param :

4.7.2 Parameter CPU

Supported parameters

The CPU does not evaluate each parameter, which may be set at the hardware configuration. The parameters of the following registers are not supported: Synchronous cycle interrupts, communication and web. The following parameters are currently supported:

General

- Short description
 - The short description of the Siemens CPU is CPU 314C-2 PN/DP (314-6EH04-0AB0 V3.3).
- Order No. / Firmware
 - Order number and firmware are identical to the details in the "hardware catalog" window.
- Name
 - The Name field provides the short description of the CPU.
 - If you change the name the new name appears in the Siemens SIMATIC Manager.
- Plant designation
 - Here is the possibility to specify a plant designation for the CPU.
 - This plant designation identifies parts of the plant according to their function.
 - Its structure is hierarchic according to IEC 81346-1.
- Location designation
 - The location designation is part of the resource designation.
 - Here the exact location of your module within a plant may be specified.
- Comment
 - In this field information about the module may be entered.

Startup

- Startup when expected/actual configuration differs
 - If the checkbox for '*Startup when expected/actual configuration differ*' is deselected and at least one module is not located at its configured slot or if another type of module is inserted there instead, then the CPU does not switch to RUN mode and remains in STOP mode.
 - If the checkbox for '*Startup when expected/actual configuration differ*' is selected, then the CPU starts even if there are modules not located in their configured slots or if another type of module is inserted there instead, such as during an initial system start-up.
- Monitoring time for ready message by modules [100ms]
 - This operation specifies the maximum time for the ready message of every configured module after PowerON.
 - Here connected PROFIBUS DP slaves are also considered until they are parameterized.
 - If the modules do not send a ready message to the CPU by the time the monitoring time has expired, the actual configuration becomes unequal to the preset configuration.
- Monitoring time for transfer of parameters to modules [100ms]
 - The maximum time for the transfer of parameters to parameterizable modules.
 - Here connected PROFINET IO devices also considered until they are parameterized.
 - If not every module has been assigned parameters by the time this monitoring time has expired; the actual configuration becomes unequal to the preset configuration.

Cycle / Clock memory

- Update OB1 process image cyclically
 - This parameter is not relevant.
- Scan cycle monitoring time
 - Here the scan cycle monitoring time in milliseconds may be set.
 - If the scan cycle time exceeds the scan cycle monitoring time, the CPU enters the STOP mode.
 - Possible reasons for exceeding the time are:
 - Communication processes
 - a series of interrupt events
 - an error in the CPU program
- Minimum scan cycle time
 - This parameter is not relevant.
- Scan cycle load from Communication
 - Using this parameter you can control the duration of communication processes, which always extend the scan cycle time so it does not exceed a specified length.
 - If the cycle load from communication is set to 50%, the scan cycle time of OB 1 can be doubled. At the same time, the scan cycle time of OB 1 is still being influenced by asynchronous events (e.g. hardware interrupts) as well.
- Size of the process image input/output area
 - Here the size of the process image max. 2048 for the input/output periphery may be fixed (default: 256).
- OB85 call up at I/O access error
 - The preset reaction of the CPU may be changed to an I/O access error that occurs during the update of the process image by the system.
 - The VIPA CPU is preset such that OB 85 is not called if an I/O access error occurs and no entry is made in the diagnostic buffer either.
- Clock memory
 - Activate the check box if you want to use clock memory and enter the number of the memory byte.



The selected memory byte cannot be used for temporary data storage.

Retentive Memory

- Number of Memory bytes from MB0
 - Enter the number of retentive memory bytes from memory byte 0 onwards.
- Number of S7 Timers from T0
 - Enter the number of retentive S7 timers from T0 onwards. Each S7 timer occupies 2bytes.
- Number of S7 Counters from C0
 - Enter the number of retentive S7 counter from C0 onwards.
- Areas
 - This parameter is not supported.

Interrupts

- Priority
 - Here the priorities are displayed, according to which the hardware interrupt OBs are processed (hardware interrupt, time-delay interrupt, async. error interrupts).

Time-of-day interrupts

- Priority
 - This value is fixed to 2.
- Active
 - By enabling 'Active' the time-of-day interrupt function is enabled.

- Execution
 - Select how often the interrupts are to be triggered.
 - Intervals ranging from every minute to yearly are available. The intervals apply to the settings made for *start date* and *time*.
- Start date/time
 - Enter date and time of the first execution of the time-of-day interrupt.
- Process image partition
 - This parameter is not supported.

Cyclic interrupts

- Priority
 - Here the priorities may be specified according to which the corresponding cyclic interrupt is processed.
- Execution
 - Enter the time intervals in ms, in which the watchdog interrupt OBs should be processed.
 - The start time for the clock is when the operating mode switch is moved from STOP to RUN.
- Phase offset
 - Enter the delay time in ms for current execution for the watch dog interrupt. This should be performed if several watchdog interrupts are enabled.
 - Phase offset allows to distribute processing time for watchdog interrupts across the cycle.
- Process image partition
 - This parameter is not supported.

Diagnostics/Clock

- Report cause of STOP
 - Activate this parameter, if the CPU should report the cause of STOP to PG respectively OP on transition to STOP.
- Number of messages in the diagnostics buffer
 - This parameter is ignored. The CPU always has a diagnostics buffer (circular buffer) for 100 diagnostics messages.
- Synchronization type
 - Here you specify whether clock should synchronize other clocks or not.
 - as slave: The clock is synchronized by another clock.
 - as master: The clock synchronizes other clocks as master.
 - none: There is no synchronization
- Time interval
 - Time intervals within which the synchronization is to be carried out.
- Correction factor
 - Lose or gain in the clock time may be compensated within a 24 hour period by means of the correction factor in ms.
 - If the clock is 1s slow after 24 hours, you have to specify a correction factor of "+1000" ms.

Protection

- Level of protection
 - Here 1 of 3 protection levels may be set to protect the CPU from unauthorized access.
 - *Protection level 1 (default setting):*
No password adjustable, no restrictions
 - *Protection level 2 with password:*
Authorized users: read and write access
Unauthorized user: read access only
 - *Protection level 3:*
Authorized users: read and write access
Unauthorized user: no read and write access

4.8 Setting VIPA specific CPU parameters

Overview

Except of the VIPA specific CPU parameters the CPU parametrization takes place in the parameter dialog of the CPU 314C-2 PN/DP (314-6EH04-0AB0 V3.3) from Siemens. After the hardware configuration of the CPU you can set the parameters of the CPU in the virtual IO device 'VIPA MICRO PLC'. Via double-click at 'VIPA MICRO PLC M13-CCF0000' the properties dialog is opened.

Here the following parameters may be accessed:

- Additional retentive memory
- Additional retentive timer
- Additional retentive counter
- Diagnostics interrupt DI power section supply
- Diagnostics interrupt DO power section supply
- Diagnostics interrupt DO short circuit/overload
- OB 80 for timer interrupts
- PN MultipleWrite

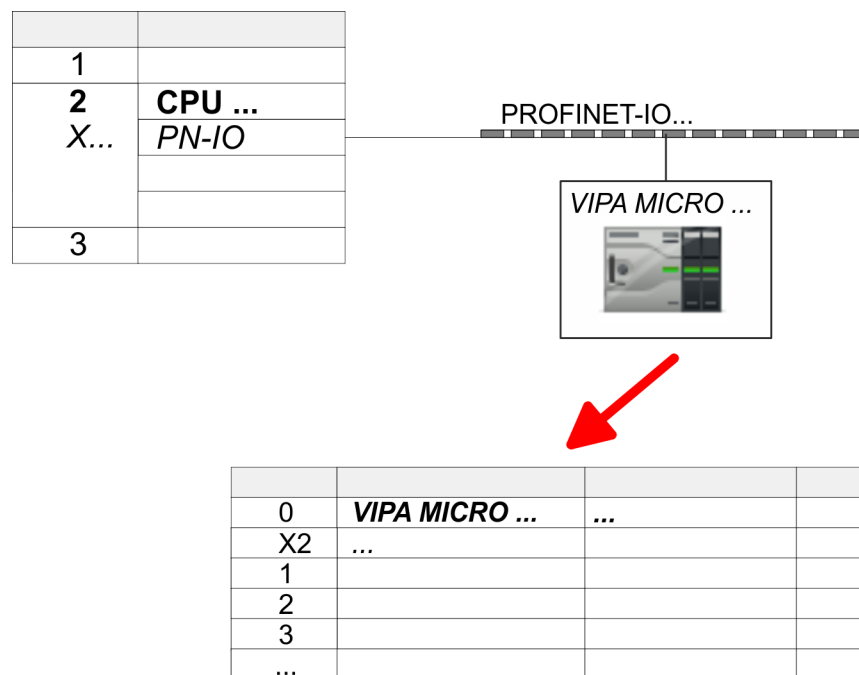

VIPA specific parameters

The following parameters may be accessed by means of the properties dialog of the VIPA CPU.

- Additional retentive memory
 - Here enter the number of retentive memory bytes. With 0 the value *'Retentive memory → Number of memory bytes starting with MB0'* is set, which is pre-set at the parameters of the Siemens CPU.
 - Range of values: 0 (default) ... 8192
- Additional retentive timer
 - Enter the number of S7 timers. With 0 the value *'Retentive memory → Number S7 timers starting with T0'* is set, which is pre-set at the parameters of the Siemens CPU.
 - Range of values: 0 (default) ... 512
- Additional retentive counter
 - Enter the number of S7 counter. With 0 the value *'Retentive memory → Number S7 counters starting with C0'* is set, which is pre-set at the parameters of the Siemens CPU.
 - Range of values: 0 (default) ... 512
- Diagnostics interrupt (default: deactivated)
 - Diagnostics interrupt DI power section supply
Error: 3L+ (DC 24V DI power section supply) missing respectively <19V
 - Diagnostics interrupt DO power section supply
Error: 4L+ (DC 24V DO power section supply) missing respectively <19V
 - Diagnostics interrupt DO short circuit/overload
Error: Short circuit or overload of an digital output respectively current exceeds 0.5A.
- OB 80 for timer interrupts
 - Here you can define at which timer interrupt OB the OB 80 (time error) is to be called.
 - Range of values: Disabled (default), selection of the corresponding OB
- PN MultipleWrite
 - In the activated state, parameter record sets are combined at PROFINET to one or more Ethernet frames during the connection setup. This speeds up the connection setup, since a separate Ethernet frame is not used for each parameter record set.

4.9 Project transfer

Overview

There is the following possibility for project transfer into the CPU:

- Transfer via Ethernet
- Transfer via memory card
- Option: Transfer via MPI ↪ *Chap. 4.9.3 'Option: Transfer via MPI' page 82*

4.9.1 Transfer via Ethernet

Initialization

So that you may access the according Ethernet interface you have to assign IP address parameters by means of the "initialization".

- X3/X4: Ethernet PG/OP channel
 - ↪ *Chap. 4.6 'Hardware configuration - Ethernet PG/OP channel' page 71*

Transfer

1. ➤ For the transfer, connect, if not already done, the appropriate Ethernet port to your Ethernet.
2. ➤ Open your project with the Siemens SIMATIC Manager.

Project transfer > Option: Transfer via MPI

3. ➤ Set via 'Options → Set PG/PC Interface' the access path to "TCP/IP → Network card".
4. ➤ Click to 'PLC → Download' Download → the dialog "Select target module" is opened. Select your target module and enter the IP address parameters of the Ethernet PG/OP channel for connection. Provided that no new hardware configuration is transferred to the CPU, the entered Ethernet connection is permanently stored in the project as transfer channel.
5. ➤ With [OK] the transfer is started.



System dependent you get a message that the projected system differs from target system. This message may be accepted by [OK].

→ Your project is transferred and may be executed in the CPU after transfer.

4.9.2 Transfer via memory card

Proceeding transfer via memory card

The memory card serves as external storage medium. There may be stored several projects and sub-directories on a memory card. Please regard that your current project is stored in the root directory and has one of the following file names:



- S7PROG.WLD
- AUTOLOAD.WLD

1. ➤ Start the Siemens SIMATIC Manager with your project
2. ➤ Create with 'File → Memory Card File → New' a new wld file.
3. ➤ Copy the blocks from the project blocks folder and the *System data* into the wld file.
4. ➤ Copy the wld file at a suited memory card. Plug this into your CPU and start it again.

⇒ The transfer of the application program from the memory card into the CPU takes place depending on the file name after an overall reset or PowerON.

S7PROG.WLD is read from the memory card after overall reset.

AUTOLOAD.WLD is read from the memory card after PowerON.

The flickering of the yellow LED  of the status bar of the CPU marks the active transfer. Please regard that your user memory serves for enough space for your user program, otherwise your user program is not completely loaded and the red LED  of the status bar lights up.

4.9.3 Option: Transfer via MPI

General

For the transfer via MPI the use of the optionally available extension module EM M09 is required. The extension module provides the interface X2: MPI(PB) with fixed pin assignment. ↪ *Chap. 2.4 'Mounting' page 14*

Net structure

The structure of a MPI net is electrically identical with the structure of a PROFIBUS net. This means the same rules are valid and you use the same components for the build-up. The single participants are connected with each other via bus interface plugs and PROFIBUS cables. Per default the MPI net runs with 187.5kbaud. VIPA CPUs are delivered with MPI address 2.

MPI programming cable

The MPI programming cables are available at VIPA in different variants. The cables provide a RS232 res. USB plug for the PC and a bus enabled RS485 plug for the CPU. Due to the RS485 connection you may plug the MPI programming cables directly to an already plugged plug on the RS485 jack. Every bus participant identifies itself at the bus with a unique address, in the course of the address 0 is reserved for programming devices.

Terminating resistor

A cable has to be terminated with its surge impedance. For this you switch on the terminating resistor at the first and the last participant of a network or a segment. Please make sure that the participants with the activated terminating resistors are always power supplied. Otherwise it may cause interferences on the bus.

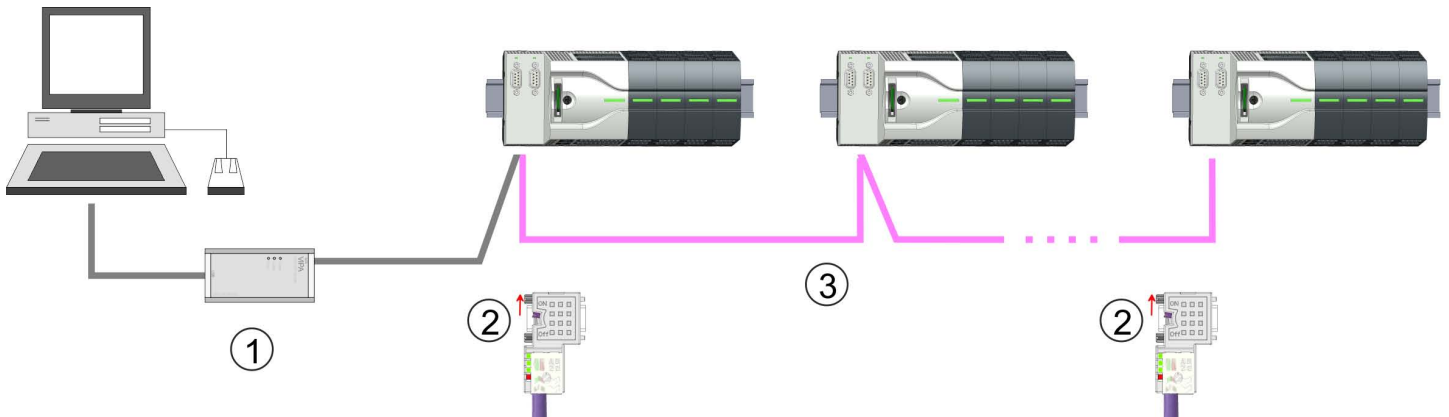

- 1 MPI programming cable
- 2 Activate the terminating resistor via switch
- 3 MPI network

Proceeding enabling the interface

A hardware configuration to enable the MPI interface is not necessary. By installing the extension module EM M09 the MPI interface is enabled.

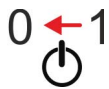

1. Turn off the power supply.

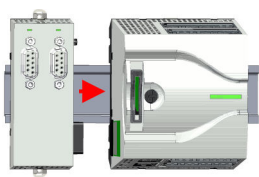

2. Mount the extension module. [Chap. 2.4 'Mounting' page 14](#)

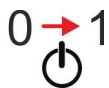

3. Switch on the power supply.

⇒ After a short boot time the interface X2 MPI(PB) is ready for MPI communication with the MPI address 2.

Approach transfer via MPI interface

- 1. Connect your PC to the MPI jack of your CPU via a MPI programming cable.
- 2. Load your project in the SIMATIC Manager from Siemens.
- 3. Choose in the menu 'Options → Set PG/PC interface'.
- 4. Select in the according list the "PC Adapter (MPI)"; if appropriate you have to add it first, then click on [Properties].
- 5. Set in the register MPI the transfer parameters of your MPI net and type a valid address.
- 6. Switch to the register Local connection.

Project transfer > Option: Transfer via MPI

7. ➤ Set the COM port of the PCs and the transfer rate 38400baud for the MPI programming cable.
8. ➤ Transfer your project via '*PLC → Load to module*' via MPI to the CPU and save it with '*PLC → Copy RAM to ROM*' on a memory card if one is plugged.

4.10 Accessing the web server

Overview

The CPU has a web server integrated. This provides access to:

- Device web page
- *WebVisu* project

4.10.1 Device web page

Overview

- Dynamic web page, which exclusively outputs information.
- On the *device web page* you will find information about your CPU, the connected modules and your *WebVisu* project.
- The shown values cannot be changed.
- Access is via the IP address of the Ethernet PG/OP channel. ↪ *Chap. 4.6 'Hardware configuration - Ethernet PG/OP channel' page 71*
- You can access the IP address with a web browser.



It is assumed that there is a connection between PC and CPU with web browser via the Ethernet PG/OP channel. This may be tested by Ping to the IP address of the Ethernet PG/OP channel.

4.10.1.1 Web page with selected CPU

Tab: 'Info'

Name	Value
Ordering Info	
Serial	
Version	
HW Revision	
Software	
Package	

[Expert View ...]

Name	Value	
Ordering number	M13-CCF0000	Order number of the CPU
Serial	...	Serial number of the CPU
Version	01V...	Version number of the CPU
HW Revision	01	CPU hardware version
Software	2.4.12	CPU firmware version
Package	Pb000292.pkb	File name for the firmware update

Accessing the web server > Device web page

[Expert View] takes you to the advanced "Expert View".

Runtime Information		CPU
Operation Mode	STOP_INTERNAL	Mode
Mode Switch	STOP	
System Time	29.03.17 08:34:14:486	Date, time
Up Time	0 days 02 hrs 07 min 08 sec	Time to change the operating mode
Last Change to RUN	n/a	
Last Change to STOP	29.03.17 16:09:03:494	
OB1-Cycle Time	cur = 0us, min = 0us, max = 0us, avg = 0us	Cyclic time: min = minimum cur = current max = maximum avg = average

Interface Information			Interface
X1/X5	DI 16	Address 136..137	Digital input
	AI 2	Address 800..803	Analog input
	Counter	Address 816..831	Counter
X2/X6	DO 12	Address 136..137	Digital output
	Counter	Address 816..831	Counter
X3	PG/OP Ethernet Port 1	Address 2025..2040	Ethernet PG/OP channel
X4	PG/OP Ethernet Port 2	Address 2025..2040	
Serial X1	PTP		PtP: Point to point operation (RS422/485)
Serial X2	MPI	Address 2047	Operating mode RS485 MPI: MPI operation or PROFIBUS DP slave mode

Card Information	
No card inserted	Information about the memory card

Active Feature Set Information	
No feature activated	Information about enabled functions

Memory Usage				CPU
	free	used	max	Information on the memory expansion Load memory, working memory (code/data)
LoadMem	128.0 kByte	0 byte	128.0 kByte	
WorkMemCode	32.0 kByte	0 byte	32.0 kByte	
WorkMemData	32.0 kByte	0 byte	32.0 kByte	

PG/OP Network Information		Ethernet PG/OP channel
Device Name	Onboard PG/OP	Name
IP Address	172.20.139.76	Address information
Subnet Mask	255.255.255.0	
Gateway Address	172.20.139.76	
MAC Address	00:20:D5:02:6C:27	
Link Mode X3	100 Mbps - Full Duplex	Link Mode and speed
Link Mode X4	Not Available	

CPU Firmware Information		CPU
File System	V1.0.2	Name, firmware version, package
PRODUCT	VIPA M13-CCF0000 V2.4.12 Px000292.pkg	
HARDWARE	V0.1.0.0 5852A-V11 MX000313.102	
BOOTLOADER	Bx000715 V126	
Bx000501	V2.2.5.0	
Ax000136	V1.0.6.0	
Ax000150	V1.1.4.0	
fx000018.wld	V1.0.2.0	
syslibex.wld	n/a	
Protect.wld	n/a	

ARM Processor Load		CPU
Measurement Cycle Time	100 ms	Information for the support
Last Value	9%	
Average Of Last 10 Values	9%	
Minimum Load	9%	
Maximum Load	26%	

Tab: 'Data' Currently nothing is displayed here.

Tab: 'Parameter' Currently nothing is displayed here.

Tab: 'IP' Here the IP address data of your Ethernet PG/OP channel are shown.

Accessing the web server > Device web page

4.10.1.1.1 Tab: 'WebVisu'

Information about the web visualization ('WebVisu') are shown here. The creation of a 'WebVisu' project is only possible with the *SPEED7 Studio V. 1.7* and up.



Device (VIPA M13-CCF0000) WebVisu

General Information

Feature	activated
Status	running
User authentication	not activated

Statistics

	free	used	max
Sessions	4	0	4
Subscribed items	-	0	-
Subscribed strings	-	0	-
Website Project	1.76 MByte	8.24 MByte	10.00 MByte

Link

Wevisu via HTTP	http://192.168.72.120:8080
Webvisu via HTTPS	https://192.168.72.120:443



For your CPU can process a WebVisu project, you have to activate the WebVisu functionality. ↪ Chap. 10.7.1 'Activate WebVisu functionality' page 249

General Information

- Feature
 - activated: The *WebVisu* functionality is activated.
 - not activated: The *WebVisu* functionality is not activated.
- Status
 - The status of your *WebVisu* project is shown here. ↪ Chap. 10.7.5 'Status of the *WebVisu*' page 253
- User authentication
 - activated: User authentication is activated. Access to the *WebVisu* happens via a login by user name and password.
 - not activated: User authentication is de-activated. Access to the *WebVisu* is unsecured.

Statistics

Statistical information about your *WebVisu* project are shown here.

- Sessions: Number of sessions, i.e. online connections to this *WebVisu* project. A session corresponds to an open window or tab in a web browser.
 - free: Number of sessions still possible.
 - used: Number of active sessions. For the number of active sessions, it is not relevant whether the sessions were started by the same or different users.
 - max.: Number of sessions still possible. The maximum number of sessions is device specific and specified in the technical data.
- Subscribed items: Number of variables including strings.
 - free: Here nothing is shown.
 - used: Number of variables used.
 - max.: Here nothing is shown.

- Subscribed strings: Number of strings or character chains.
 - free: Here nothing is shown.
 - used: Number of strings used.
 - max.: Here nothing is shown.
- WebVisu Project: Information on the memory allocation for the *WebVisu* project.
 - free: Still free space for the *WebVisu* project.
 - used: Size of the current *WebVisu* project.
 - max.: Maximum available space for a *WebVisu* project.

Link In *Status 'running'* the links to access your *WebVisu* are listed here.

4.10.1.2 Web page with selected module

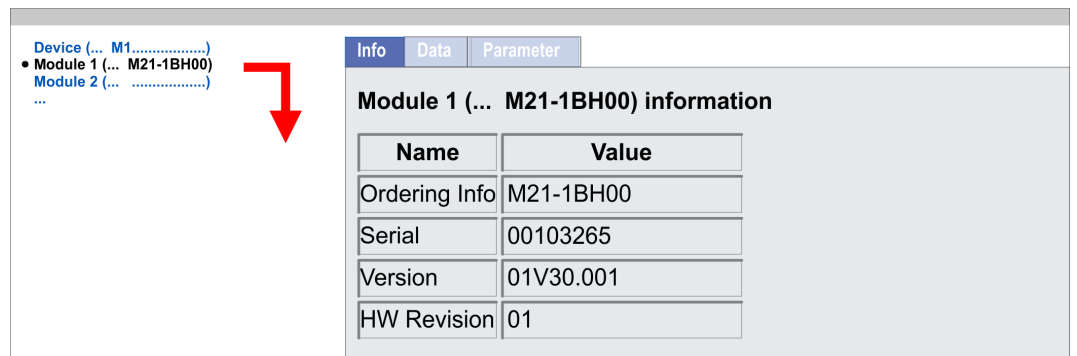

Tab: 'Info' Here product name, order number, serial number, firmware version and hardware state number of the according module are listed.

Tab: 'Data' Here the address and the state of the inputs respectively outputs are listed. Please note with the outputs that here exclusively the states of outputs can be shown, which are within the OB 1 process image.

Tab: 'Parameter' With parametrizable modules e.g. analog modules the parameter setting is shown here. These come from the hardware configuration.

4.10.2 *WebVisu* project

- With a *WebVisu* project there is the possibility to configure a web visualization on your CPU.
- The configuration of a *WebVisu* project is only possible with the *SPEED7 Studio V 1.7* and up.
- Since a *WebVisu* project is only executable by memory card, a memory card of VIPA (VSD, VSC) must be plugged.
 - ↳ *Chap. 4.15 'Deployment storage media - VSD, VSC' page 98*
- The *WebVisu* functionality must be activated in the CPU.
 - ↳ *Chap. 10.7.1 'Activate WebVisu functionality' page 249*
- When the project is transferred from the *SPEED7 Studio*, the *WebVisu* project is automatically transferred to the inserted memory card.

Accessing the web server > WebVisu project

- Access happens by the IP address of the Ethernet PG/OP channel and the correspondingly configured port or via the *device web page*
- You can access your web visualization via a web browser. Web browsers based on Windows CE are currently not supported.



Please note that the use of a WebVisu project, depending on the scope of the WebVisu project and the PLC project, can influence the performance and thus the response time of your application.

🔗 *Chap. 10.7 'Deployment Web visualization' page 248*

4.11 Operating modes

4.11.1 Overview

The CPU has 4 operating modes:





- Operating mode STOP
- Operating mode START-UP
(OB 100 - restart / OB 102 - cold start *)
- Operating mode RUN
- Operating mode HOLD

Certain conditions in the operating modes START-UP and RUN require a specific reaction from the system program. In this case the application interface is often provided by a call to an organization block that was included specifically for this event.

Operating mode STOP

- The application program is not processed.
- If there has been a processing before, the values of counters, timers, flags and the process image are retained during the transition to the STOP mode.
- Command output disable (BASP) is activated this means the all digital outputs are disabled.
- : The yellow LED of the status bar lights up in the STOP state.

Operating mode START-UP

- : After PowerON the yellow LED of the status bar blinks in the STOP state.
- : After a short time the flashing changes to a steady light.
- During the transition from STOP to RUN a call is issued to the start-up organization block OB 100.
 - The processing time for this OB is not monitored.
 - The START-UP OB may issue calls to other blocks.
 - All digital outputs are disabled during the START-UP, this means BASP is activated.
 - : The green LEDs blinks as soon as the OB 100 is operated and for at least 3s, even if the start-up time is shorter or the CPU gets to STOP due to an error.
 - : The green LEDs of the status bar lights up when the START-UP is completed and the CPU is in the RUN state.



* OB 102 (Cold start)

If there is a "Watchdog" error the CPU still remains in STOP state. With such an error the CPU must be manually started again. For this the OB 102 (cold start) must exist. The CPU will not go to RUN without the OB 102. Alternatively you can bring your CPU in RUN state again by an overall reset respectively by reloading your project.

Please consider that the OB 102 (cold start) may exclusively be used for treatment of a watchdog error.

Operating mode RUN

- : The green LED lights up when the CPU is in the RUN state.
- The application program in OB 1 is processed in a cycle. Under the control of alarms other program sections can be included in the cycle.
- All timers and counters being started by the program are active and the process image is updated with every cycle.
- BASP is deactivated, i.e. all outputs are enabled.

Operating mode HOLD







The CPU offers up to 3 breakpoints to be defined for program diagnosis. Setting and deletion of breakpoints happens in your programming environment. As soon as a breakpoint is reached, you may process your program step by step.

Precondition

For the usage of breakpoints, the following preconditions have to be fulfilled:

- Testing in single step mode is possible with STL. If necessary switch the view via 'View → STL' to STL.
- The block must be opened online and must not be protected.

Approach for working with breakpoints

1.  Activate 'View → Breakpoint Bar'.
2.  Set the cursor to the command line where you want to insert a breakpoint.
3.  Set the breakpoint with 'Debug → Set Breakpoint'.
⇒ The according command line is marked with a circle.
4.  To activate the breakpoint click on 'Debug → Breakpoints Active'.
⇒ The circle is changed to a filled circle.
5.  Bring your CPU into RUN.
⇒ When the program reaches the breakpoint, your CPU switches to the state HOLD, the breakpoint is marked with an arrow and the register contents are monitored.
6.  Now you may execute the program code step by step via 'Debug → Execute Next Statement' or run the program until the next breakpoint via 'Debug → Resume'.
7.  Delete (all) breakpoints with the option 'Debug → Delete All Breakpoints'.

Behavior in operating state HOLD

-  Red LED is on and green LED blinks with 1Hz: CPU is in STOP state, configured holding point reached.
- The execution of the code is stopped. No level is further executed.
- All times are frozen.
- The real-time clock runs is just running.
- The outputs were disabled (BASP is activated).
- Configured CP connections remain exist.



The usage of breakpoints is always possible. Switching to the operating mode test operation is not necessary.

With more than 2 breakpoints, a single step execution is not possible.

4.11.2 Function security

The CPUs include security mechanisms like a Watchdog (100ms) and a parameterizable cycle time surveillance (parameterizable min. 1ms) that stop res. execute a RESET at the CPU in case of an error and set it into a defined STOP state. The VIPA CPUs are developed function secure and have the following system properties:

Event	concerns	Effect
RUN → STOP	general	BASP (B efehls- A usgabe- S perre, i.e. command output lock) is set.
	central digital outputs	The outputs are disabled.
	central analog outputs	The outputs are disabled. <ul style="list-style-type: none"> ■ Voltage outputs issue 0V ■ Current outputs 0...20mA issue 0mA ■ Current outputs 4...20mA issue 4mA If configured also substitute values may be issued.
	decentral outputs	Same behaviour as the central digital/analog outputs.
	decentral inputs	The inputs are cyclically be read by the decentralized station and the recent values are put at disposal.
STOP → RUN res. PowerON	general	First the PII is deleted, then OB 100 is called. After the execution of the OB, the BASP is reset and the cycle starts with: Delete PIO → Read PII → OB 1.
	decentral inputs	The inputs are be read by the decentralized station and the recent values are put at disposal.
RUN	general	The program is cyclically executed: Read PII → OB 1 → Write PIO.
PII = Process image inputs		
PIO = Process image outputs		

4.12 Overall reset

Overview

During the overall reset the entire user memory is erased. Data located in the memory card is not affected. You have 2 options to initiate an overall reset:

- Overall reset by means of the operating mode switch
- Overall reset by means of the Siemens SIMATIC Manager



You should always establish an overall reset to your CPU before loading an application program into your CPU to ensure that all blocks have been cleared from the CPU.

4.12.1 Overall reset by means of the operating mode switch

Proceeding

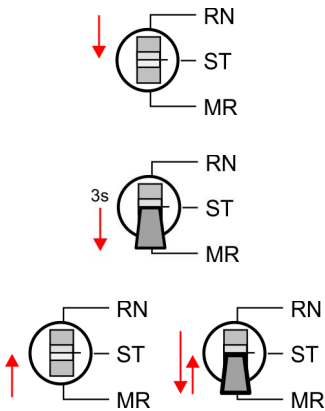

1. Your CPU must be in STOP mode. For this switch the operating mode switch of the CPU to STOP.

⇒ Status bar:

2. Switch the operating mode switch to MR position for about 3 seconds.

⇒ The yellow LED blinks with 1Hz and changes from repeated blinking to permanently on.

3. Place the operating mode switch in the position STOP and switch it to MR and quickly back to STOP within a period of less than 3 seconds.

⇒ The overall reset is carried out. Here the yellow LED blinks with 2Hz .

4. The overall reset has been completed when the yellow LED is on permanently .

4.12.2 Overall reset by means of the Siemens SIMATIC Manager

Proceeding

For the following proceeding you must be online connected to your CPU.

1. For an overall reset the CPU must be switched to STOP state. You may place the CPU in STOP by the menu command 'PLC → Operating mode'.

2. You may request the overall reset by means of the menu command 'PLC → Clean/Reset'.

⇒ A dialog window opens. Here you can bring your CPU in STOP state, if not already done, and start the overall reset. During the overall reset the yellow LED of the status bar blinks with 2Hz . The overall reset has been completed when the yellow LED is on permanently .

4.12.3 Actions after the overall reset

Activating functionalities by means of a VSC

If there is a VSC memory card from VIPA plugged, after an overall reset the according functionalities are automatically activated. ↪ *Chap. 4.15 'Deployment storage media - VSD, VSC' page 98*

Automatic reload

If there is a project S7PROG.WLD on the memory card, after an overall reset the CPU attempts to reload this project from the memory card. Here the yellow LED of the status line flickers . The operating mode of the CPU will be STOP respectively RUN, depending on the position of the operating mode switch.

Factory reset

The *Reset to factory setting* deletes completely the internal RAM of the CPU and resets this to delivery state. Please regard that the MPI address is also set back to default 2!
↳ *Chap. 4.14 'Reset to factory settings' page 97*

4.13 Firmware update

Overview

There is the opportunity to execute a firmware update for the CPU and its components via memory card. For this an accordingly prepared memory card must be in the CPU during the start-up. So a firmware files can be recognized and assigned with start-up, a .pkb file name is reserved for each hardware release, which begins with "pb" and differs in a number with 6 digits. In the VIPA System MICRO CPU, you can access the .pkb file name from the web page. After PowerON and operating mode switch of the CPU in STOP, the CPU checks if there is a *.pkb file at the memory card. If this firmware version is different to the existing firmware version, this is indicated by alternately blinking (1Hz) of the red and yellow LED  of the status bar and you can install the firmware via an update request.



The procedure here describes the update from the CPU firmware version 2.4.0 and up. The update of an older version to the firmware version 2.4.0 has to be done via .pkg files. For this refer to the corresponding manual for your CPU version.

Current firmware at www.vipa.com

The latest firmware versions can be found in the service area at www.vipa.com. For example the following file is necessary for the firmware update of the CPU M13-CCF0000 and its components with hardware release 01:

- CPU M13C, Hardware release 01: Pb000292.pkb



CAUTION!

When installing a new firmware you have to be extremely careful. Under certain circumstances you may destroy the CPU, for example if the voltage supply is interrupted during transfer or if the firmware file is defective. In this case, please call our hotline!

Please regard that the version of the update firmware has to be different from the existing firmware otherwise no update is executed.

Show the firmware version via web page

The CPU has an integrated *device web page* that also shows information about the firmware version via 'Expert View'. ↪ *Chap. 4.10.1 'Device web page' page 85*

Load firmware and transfer it to memory card

1. ➤ Go to www.vipa.com
2. ➤ Click at 'Service Support ➔ Downloads ➔ Firmware'.
3. ➤ Via 'System MICRO ➔ CPU' navigate to your CPU and download the zip file to your PC.
4. ➤ Unzip the zip file and copy the .pkb file to the root directory of your memory card.





CAUTION!

With a firmware update an overall reset is automatically executed. If your program is only available in the load memory of the CPU it is deleted! Save your program before executing a firmware update! After a firmware update you should execute a "Reset to factory setting". ↪ *Chap. 4.14 'Reset to factory settings' page 97*

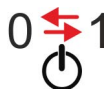
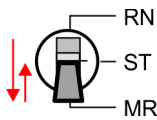
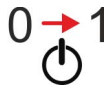
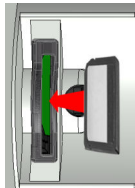
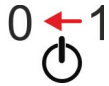
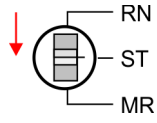
Transfer firmware from memory card into CPU



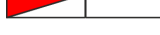

1. ➔ Switch the operating mode switch of your CPU in position STOP.
2. ➔ Turn off the power supply.
3. ➔ Plug the memory card with the firmware file into the CPU. Please take care of the correct plug-in direction of the memory card.
4. ➔ Switch on the power supply.
 - ⇒ After a short boot-up time, the alternate blinking of the red and yellow LED  of the status bar shows that at least a more current firmware file was found at the memory card.
5. ➔ You start the transfer of the firmware as soon as you tip the operating mode switch downwards to MR within 10s and then leave the switch in STOP position.
6. ➔ During the update process, the yellow LED of the status bar flashes or flickers . This may last several minutes.
7. ➔ The update is completed without errors when the red and yellow LEDs of the status bar are flashing (1Hz) . If only the red LED of the status bar  is flashing, an error has occurred.
8. ➔ Turn power OFF and ON.
9. ➔ Now execute a *Reset to factory setting*. After that the CPU is ready for duty.
 - ↳ *Chap. 4.14 'Reset to factory settings' page 97*

4.14 Reset to factory settings

Proceeding

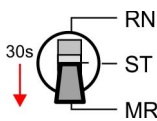
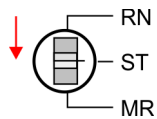
- With the following proceeding the internal RAM of the CPU is completely deleted and the CPU is reset to delivery state.
- Please regard that the MPI address is also reset to default 2 and the IP address of the Ethernet PG/OP channel is reset to 0.0.0.0!
- A *factory reset* may also be executed by the command `FACTORY_RESET`. ↳ *Chap. 4.17 'CMD - auto commands' page 102*



1. ➔ Switch the CPU to STOP.
2. ➔ Push the operating mode switch down to position MR for 30 seconds. Here the yellow LED of the status bar blinks . After a few seconds the LED changes to static light. Now the LED changes between static light and blinking. Start here to count the static light of the LED.

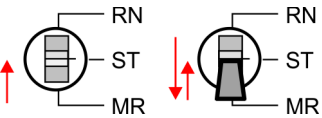

3. → After the 6. static light release the operating mode switch and tip it downwards to MR.

⇒ To confirm the reset process the yellow LED of the status bar blinks (2Hz) . This means that the RAM was deleted completely.



If the yellow LED of the status bar is on , only an overall reset has been performed and the reset to factory setting has been failed. In this case you can repeat the procedure. A factory reset can only be executed if the yellow LED has static light for exact 6 times.

4. → The reset process is completed when the red and yellow LEDs of the status bar are blinking (1Hz) .

5. → Turn power OFF and ON.

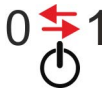

After a firmware update of the CPU you always should execute a factory reset.

4.15 Deployment storage media - VSD, VSC

Overview

At the front of the CPU there is a slot for storage media. Here the following storage media can be plugged:

- VSD - VIPA **SD**-Card
 - External memory card for programs and firmware.
- VSC - VIPA**Set**Card
 - External memory card (VSD) for programs and firmware with the possibility to unlock optional functions like work memory and field bus interfaces.
 - These functions can be purchased separately.
 - To activate the corresponding card is to be installed and a *Overall reset* is to be established. ↪ *Chap. 4.12 'Overall reset' page 94*



To avoid malfunctions, you should use memory cards of VIPA. These correspond to the industrial standard. A list of the currently available VSD respectively VSC can be found at www.vipa.com

You can cause the CPU to load a project automatically respectively to execute a command file by means of pre-defined file names.

VSD

VSDs are external storage media based on SD memory cards. VSDs are pre-formatted with the PC format FAT 16 (max. 2GB) and can be accessed via a card reader. After PowerON respectively an overall reset the CPU checks, if there is a VSD with data valid for the CPU.

Push the VSD into the slot until it snaps in leaded by a spring mechanism. This ensures contacting. By sliding down the sliding mechanism, a just installed VSD card can be protected against drop out.

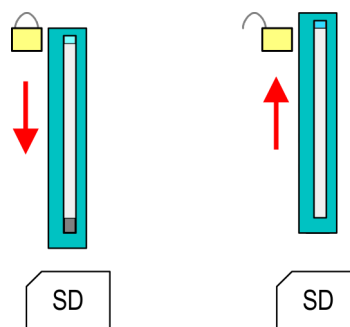

To remove, slide the sliding mechanism up again and push the storage media against the spring pressure until it is unlocked with a click.

**CAUTION!**

If the media was already unlocked by the spring mechanism, with shifting the sliding mechanism, a just installed memory card can jump out of the slot!

VSC

The VSC is a VSD with the possibility to enable optional functions. Here you have the opportunity to accordingly expand your work memory respectively enable field bus functionalities. Information about the enabled functions can be shown via the web page.

↳ *Chap. 4.10 'Accessing the web server' page 85*

**CAUTION!**

Please regard that the VSC must remain plugged when you've enabled optional functions at your CPU. Otherwise the red LED of the status bar blinks in RUN  with 1Hz and the CPU goes into STOP after 72 hours. As long as an activated VSC is not plugged in, the LED blinks and the "TrialTime" timer counts from 72 hours down to 0. The CPU then goes into STOP mode. By inserting the VSC, the LED goes out and the CPU runs again without restrictions.

The VSC cannot be exchanged with a VSC of the same optional functions. The activation code is fixed to the VSD by means of an unique serial number. Here the functionality as an external memory card is not affected.

Accessing the storage medium

To the following times an access takes place on a storage medium:

After overall reset

- The CPU checks if a VSC is inserted. If so, the corresponding optional functions are enabled.
- The CPU checks whether a project S7PROG.WLD exists. If so, it is automatically loaded.

After PowerON

- The CPU checks whether a project AUTOLOAD.WLD exists. If so, an overall reset is executed and the project is automatically loaded.
- The CPU checks whether a command file with the name VIPA_CMD.MMC exists. If so the command file is loaded and the commands are executed.
- After PowerON and CPU STOP the CPU checks if there is a *.pkb file (firmware file). If so, this is shown by the CPU by blinking LEDs and the firmware may be installed by an update request. ↪ *Chap. 4.13 'Firmware update' page 96*

In STOP state when inserting a memory card

- If a memory card is plugged in STOP state, which contains a command file VIPA_CMD.MMC, the command file is loaded and the containing instructions are executed.



The FC/SFC 208 ... FC/SFC 215 and FC/SFC 195 allow you to include the memory card access into your user application. More can be found in the manual operation list (HB00_OPL_SP7) of your CPU.

4.16 Extended know-how protection

Overview



Please note that this functionality is not supported by the Siemens TIA Portal!

Besides the "standard" Know-how protection the CPUs from VIPA provide an "extended" know-how protection that serves a secure block protection for accesses of 3. persons.

- Standard protection
 - The standard protection from Siemens transfers also protected blocks to the PG but their content is not displayed.
 - But with according manipulation the know-how protection is not guaranteed.
- Extended protection
 - The "extended" know-how protection developed by VIPA offers the opportunity to store blocks permanently in the CPU.
 - With the "extended" protection you transfer the protected blocks to a memory card into a WLD-file named protect.wld.
 - By plugging the memory card and then an overall reset the blocks in the protect.wld are permanently stored in the CPU.
 - You may protect OBs, FBs and FCs.
 - When back-reading the protected blocks into the PG, exclusively the block header are loaded. The block code that is to be protected remains in the CPU and cannot be read.

Protect blocks with protect.wld

1. ➤ Create a new wld file in the Siemens SIMATIC Manager with 'File ➔ Memory Card file ➔ New'.
2. ➤ Rename the wld file to "protect.wld".
3. ➤ Transfer the according blocks into the file by dragging them with the mouse from the project to the file window of protect.wld.
4. ➤ Transfer the file protect.wld to a memory card.
5. ➤ Plug the memory card into the CPU and execute an *overall reset*. ↪ [Chap. 4.12 'Overall reset' page 94](#)
 - ⇒ The overall reset stores the blocks in protect.wld permanently in the CPU protected from accesses of 3. persons.

Protection behaviour

Protected blocks are overwritten by a new protect.wld. Using a PG 3. persons may access protected blocks but only the block header is transferred to the PG. The block code that is to be protected remains in the CPU and cannot be read.

Change respectively delete protected blocks

Protected blocks in the RAM of the CPU may be substituted at any time by blocks with the same name. This change remains up to next overall reset. Protected blocks may permanently be overwritten only if these are deleted at the protect.wld before. A factory reset does not affect the protected blocks. By transferring an empty protect.wld from the memory card with an overall reset, you may delete all protected blocks in the CPU.

Usage of protected blocks

Due to the fact that reading of a "protected" block from the CPU monitors no symbol labels it is convenient to provide the "block covers" for the end user. For this, create a project of all protected blocks. Delete all networks in the blocks so that these only contain the variable definitions in the according symbolism.

4.17 CMD - auto commands

Overview

A *Command* file at a memory card is automatically executed under the following conditions:

- CPU is in STOP and memory card is plugged
- After each PowerON

Command file

The *Command* file is a text file, which consists of a command sequence to be stored as **vipa_cmd.mmc** in the root directory of the memory card. The file has to be started by `CMD_START` as 1. command, followed by the desired commands (no other text) and must be finished by `CMD_END` as last command.

Text after the last command `CMD_END` e.g. comments is permissible, because this is ignored. As soon as the command file is recognized and executed each action is stored at the memory card in the log file `logfile.txt`. In addition for each executed command a diagnostics entry may be found in the diagnostics buffer.

Commands

Please regard the command sequence is to be started with `CMD_START` and ended with `CMD_END`.

Command	Description	Diagnostics entry
CMD_START	In the first line <code>CMD_START</code> is to be located.	0xE801
	There is a diagnostics entry if <code>CMD_START</code> is missing.	0xE8FE
WAIT1SECOND	Waits about 1 second.	0xE803
LOAD_PROJECT	The function "Overall reset and reload from memory card" is executed. The <code>wld</code> file located after the command is loaded else "s7prog.wld" is loaded.	0xE805
SAVE_PROJECT	The recent project (blocks and hardware configuration) is stored as "s7prog.wld" at the memory card. If the file just exists it is renamed to "s7prog.old". If your CPU is password protected so you have to add this as parameter. Otherwise there is no project written. Example: <code>SAVE_PROJECT password</code>	0xE806
FACTORY_RESET	Executes "factory reset".	0xE807
DIAGBUF	The current diagnostics buffer of the CPU is stored as "diagbuff.txt" at the memory card.	0xE80B
SET_NETWORK	IP parameters for Ethernet PG/OP channel may be set by means of this command. The IP parameters are to be given in the order IP address, subnet mask and gateway in the format <code>x.x.x.x</code> each separated by a comma. Enter the IP address if there is no gateway used.	0xE80E
CMD_END	In the last line <code>CMD_END</code> is to be located.	0xE802
WEBPAGE	Saves all information on the device web page (Expert-View) as <code>webpage.txt</code> on the memory card ↪ <i>Chap. 4.10 'Accessing the web server' page 85</i>	0xE804
WEBVISU_PGOP_ENABLE	Enable <i>WebVisu</i> project via Ethernet PG/OP channel	0xE82C

Command	Description	Diagnostics entry
WEBVISU_PGOP_DISABLE*	Disable <i>WebVisu</i> project via Ethernet PG/OP channel	0xE82D
*) After a power cycle or loading a hardware configuration, the settings are retained. With <i>reset to the factory settings</i> or <i>over all reset</i> , the <i>WebVisu</i> project is set to the default value "enabled".		

Examples

The structure of a command file is shown in the following. The corresponding diagnostics entry is put in brackets

Example 1

CMD_START	Marks the start of the command sequence (0xE801)
LOAD_PROJECT proj.wld	Execute an overall reset and load "proj.wld" (0xE805)
WAIT1SECOND	Wait ca. 1s (0xE803)
DIAGBUF	Store diagnostics buffer of the CPU as "diagbuff.txt" (0xE80B)
CMD_END	Marks the end of the command sequence (0xE802)
... arbitrary text ...	Text after the command CMD_END is not evaluated.

Example 2

CMD_START	Marks the start of the command sequence (0xE801)
LOAD_PROJECT proj2.wld	Execute an overall reset and load "proj2.wld" (0xE805)
WAIT1SECOND	Wait ca. 1s (0xE803)
WAIT1SECOND	Wait ca. 1s (0xE803)
	IP parameter (0xE80E)
SET_NETWORK 172.16.129.210,255.255.224.0,172.16.129.210	
WAIT1SECOND	Wait ca. 1s (0xE803)
WAIT1SECOND	Wait ca. 1s (0xE803)
DIAGBUF	Store diagnostics buffer of the CPU as "diagbuff.txt" (0xE80B)
CMD_END	Marks the end of the command sequence (0xE802)
... arbitrary text ...	Text after the command CMD_END is not evaluated.



The parameters IP address, subnet mask and gateway may be received from the system administrator. Enter the IP address if there is no gateway used.

4.18 Control and monitoring of variables with test functions

Overview

- For troubleshooting purposes and to display the status of certain variables you can access certain test functions via the menu item **Debug** of the Siemens SIMATIC Manager.
- The status of the operands and the RLO can be displayed by means of the test function '*Debug → Monitor*'.
- The status of the operands and the RLO can be displayed by means of the test function '*PLC → Monitor/Modify Variables*'.

'Debug → Monitor'

- This test function displays the current status and the RLO of the different operands while the program is being executed.
- It is also possible to enter corrections to the program.
- The processing of the states may be interrupted by means of jump commands or by timer and process-related interrupts.
- At the breakpoint the CPU stops collecting data for the status display and instead of the required data it only provides the PG with data containing the value 0.
- The interruption of the processing of statuses does not change the execution of the program. It only shows that the data displayed is no longer valid.



When using the test function "Monitor" the PLC must be in RUN mode!

For this reason, jumps or time and process alarms can result in the value displayed during program execution remaining at 0 for the items below:

- the result of the logical operation RLO
- Status / AKKU 1
- AKKU 2
- Condition byte
- absolute memory address SAZ. In this case SAZ is followed by a "?".

**'PLC
→ Monitor/Modify
Variables'**

This test function returns the condition of a selected operand (inputs, outputs, flags, data word, counters or timers) at the end of program execution. This information is obtained from the corresponding area of the selected operands. During the controlling of variables respectively in operating mode STOP the input area is directly read. Otherwise only the process image of the selected operands is displayed.

- Control of outputs
 - Serves to check the wiring and proper operation of output modules.
 - If the CPU is in RUN mode, so only outputs can be controlled, which are not controlled by the user program. Otherwise values would be instantly overwritten.
 - If the CPU is in STOP - even without user program, so you need to disable the command output lock BASP ('Enable PO'). Then you can control the outputs arbitrarily
- Controlling variables
 - The following variables may be modified: I, Q, M, T, C and D.
 - The process image of binary and digital operands is modified independently of the operating mode of the CPU.
 - When the operating mode is RUN the program is executed with the modified process variable. When the program continues they may, however, be modified again without notification.
- Forcing variables
 - You can pre-set individual variables of a user program with fixed values so that they can not be changed or overwritten by the user program of the CPU.
 - By pre-setting of variables with fixed values, you can set certain situations for your user program and thus test the programmed functions.



CAUTION!

- Please consider that controlling of output values represents a potentially dangerous condition.
- Even after a power cycle forced variables remain forced with its value, until the force function is disabled.
- These functions should only be used for test purposes respectively for troubleshooting. More information about the usage of these functions may be found in the manual of your configuration tool.

4.19 Diagnostic entries

Accessing diagnostic data ↪ *Appendix A 'System specific event IDs' page 274*

- You may read the diagnostics buffer of the CPU via the Siemens SIMATIC Manager. Besides of the standard entries in the diagnostics buffer, the VIPA CPUs support some additional specific entries as Event-IDs.
- To monitor the diagnostics entries you choose in the Siemens SIMATIC manager 'PLC → Module information'. Via the register "Diagnostics Buffer" you reach the diagnostics window.
- The current content of the diagnostic buffer is stored at the memory card by means of the CMD DIAGBUF. ↪ *Chap. 4.17 'CMD - auto commands' page 102*
- The diagnostic is independent from the operating mode of the CPU. You may store a max. of 100 diagnostic entries in the CPU.

5 Deployment I/O periphery

5.1 Overview

Project engineering and parametrization

- On this CPU the connectors for digital respectively analog signal and *Technological functions* are combined in a one casing.
- The project engineering happens in the Siemens SIMATIC Manager as Siemens CPU 314C-2 PN/DP (314-6EH04-0AB0 V3.3). Here the CPU M13-CCF0000 is parameterized via the *'Properties'* dialog of the Siemens CPU 314C-2 PN/DP (314-6EH04-0AB0 V3.3).
- For parametrization of the digital I/O periphery and the *technological functions* the corresponding sub modules of the CPU 314C-2 PN/DP (314-6EH04-0AB0 V3.3) is to be used.
- The controlling of the operating modes of the *technological functions* happens by means of handling blocks of the user program.

I/O periphery

- The integrated I/Os of the CPU may be used for *technological functions* or as standard periphery.
- *Technological functions* and standard periphery may be used simultaneously with appropriate hardware.
- Read access to inputs used by *technological functions* is possible.
- Write access to used outputs is not possible.
- ↪ *Chap. 5.3 'Analog input' page 108*
 - AI 2xUx12Bit (0 ... 10V)
 - The analog channels of the module are not isolated to the electronic power supply.
 - The analog part has no status indication
- ↪ *Chap. 5.4 'Digital input' page 111*
 - DI 16xDC 24V
 - Interrupt functions parameterizable
 - Status indication via LEDs
- ↪ *Chap. 5.5 'Digital output' page 115*
 - DO 12xDC 24V, 0.5A
 - Status indication via LEDs

Technological functions

- ↪ *Chap. 5.6 'Counting' page 118*
 - 4 channels
 - Count once
 - Count continuously
 - Count Periodically
 - Control by the user program (SFB 47)
- ↪ *Chap. 5.7 'Frequency measurement' page 140*
 - 4 channels
 - Control by the user program (SFB 48)
- ↪ *Chap. 5.8 'Pulse width modulation - PWM' page 146*
 - 2 channels
 - Control by the user program (SFB 49)
- ↪ *Chap. 5.9 'Pulse train' page 151*
 - 2 channels
 - Control by the user program (SFB 49)

5.2 Address assignment

Sub module	Input address	Access	Assignment
AI5/AO2	800	WORD	Analog input channel 0 (X6)
	802	WORD	Analog input channel 1 (X6)

Sub module	Input address	Access	Description
DI24/DO16	136	BYTE	Digital input I+0.0 ... I+0.7 (X1)
	137	BYTE	Digital input I+1.0 ... I+1.7 (X5)

Sub module	Input address	Access	Description
Counter	816	DINT	Channel 0: Counter value / Frequency value
	820	DINT	Channel 1: Counter value / Frequency value
	824	DINT	Channel 2: Counter value / Frequency value
	828	DINT	Channel 3: Counter value / Frequency value

Sub module	Output address	Access	Description
Counter	816	DWORD	reserved
	820	DWORD	reserved
	824	DWORD	reserved
	828	DWORD	reserved

Sub module	Output address	Access	Description
DI24/DO16	136	BYTE	Digital output Q+0.0 ... Q+0.7 (X2)
	137	BYTE	Digital output Q+1.0 ... Q+1.3 (X6)

5.3 Analog input

5.3.1 Properties

- 2xUx12Bit (0 ... 10V) fixed.
- The analog channels of the module are not isolated to the electronic power supply.
- The analog part has no status indication.



Temporarily not used analog inputs must be connected to the concerning ground.

5.3.2 Analog value representation

Number representation in Siemens S7 format

Resolution	Analog value - twos complement															
	High byte (byte 0)								Low byte (byte 1)							
Bit number	15	14	13	12	11	10	9	8	7	6	5	4	3	2	1	0
Value	SG	2 ¹⁴	2 ¹³	2 ¹²	2 ¹¹	2 ¹⁰	2 ⁹	2 ⁸	2 ⁷	2 ⁶	2 ⁵	2 ⁴	2 ³	2 ²	2 ¹	2 ⁰
11Bit+sign	SG	Measuring value											X*	X*	X*	X*

*) The lowest value irrelevant bits of the output value (0) are marked with "X".

Sign bit (SG)

Here it is essential:

- Bit 15 = "0": → positive value
- Bit 15 = "1": → negative value

Behavior at error

As soon as a measured value exceeds the overdrive region respectively falls below the underdrive region, the following value is issued:

- Measuring value > end of overdrive region:
32767 (7FFFh)
- Measuring value < end of underdrive region:
-32768 (8000h)

At a parameterization error the value 32767 (7FFFh) is issued.

When leaving the defined range during analog output 0V respectively 0A is issued.

Voltage measurement

0 ... 10V

Measuring range	Voltage (U)	Decimal (D)	Hex	Range	Formulas
0 ... 10V	> 11.759V	32767	7FFFh	overflow	$D = 27648 \cdot \frac{U}{10}$ $U = D \cdot \frac{10}{27648}$
	11.759V	32511	7EFFh	overdrive range	
	10V	27648	6C00h	nominal range	
	5V	13824	3600h		
	0V	0	0000h		
	-0.8V	-2212	F75Ch	underdrive range	D: decimal value U: voltage value
	< -0.8V	-32768	8000h	underflow	

5.3.3 Wiring

X6: DC 24V, AI, DO byte 1

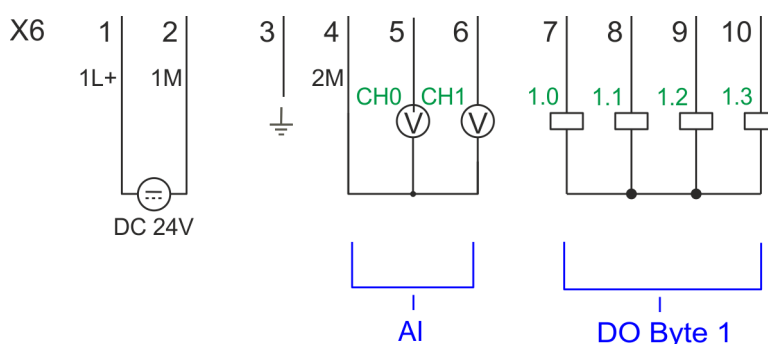

X6	Function	Type	LED ■ green	Description
1	1L+	I	■	1L+: DC 24V for electronic section supply
2	1M	I		1M: DC 0V for electronic section supply
3	⏏	I		Shield
4	2M	I		2M: Ground for analog inputs
5	AI 0	I		Analog input AI 0
6	AI 1	I		Analog input AI 1

Cables for analog signals

For the analog signals you have to use isolated cables. With this the interferences can be reduced. The shield of the analog cables should be grounded at both ends. If there are potential differences between the cables, a potential compensation current can flow, which could disturb the analog signals. In this case, you should only ground the shield at one end of the cable.



Temporarily not used analog inputs must be connected to the concerning ground.

5.3.4 Parametrization

5.3.4.1 Address assignment

Sub module	Input address	Access	Assignment
AI5/AO2	800	WORD	Analog input channel 0 (X6)
	802	WORD	Analog input channel 1 (X6)

5.3.4.2 Filter

Parameter hardware configuration

The analog input part has a filter integrated. The parametrization of the filter happens in the Siemens SIMATIC Manager via the parameter 'Integration time'. The default value of the filter is 1000ms. The following values can be entered:

- 'Input 0 ≙ Channel 0'
- 'Input 1 ≙ Channel 1'
- 'Integration time 2.5ms' ≙ 2ms (no filter)
- 'Integration time 16.6ms' ≙ 100ms (small filter)
- 'Integration time 20ms' ≙ 1000ms (medium filter)

Parametrization during runtime

By using the record set 1 of the SFC 55 "WR_PARM" you may alter the parametrization in the module during runtime.



The time needed until the new parametrization is valid can last up to 2ms. During this time, the measuring value output is 7FFFh.

Record set 1

Byte	Bit 7 ... Bit 0	Default
0	Bit 7...0: reserved	00h
1	Filter <ul style="list-style-type: none"> ■ Bit 1, 0: Analog input channel 0 Bit 3, 2: Analog input channel 1 <ul style="list-style-type: none"> – 00b: 'Integration time 2.5ms' ≙ 2ms (no filter) – 01b: 'Integration time 16.6ms' ≙ 100ms (small filter) – 10b: 'Integration time 20ms' ≙ 1000ms (medium filter) ■ Bit 7...4: reserved 	10h
2...12	Bit 7...0: reserved	

5.4 Digital input

5.4.1 Properties

- 16xDC 24V
- Maximum input frequency
 - 10 inputs: 100kHz
 - 6 inputs: 1kHz
- Interrupt functions parameterizable
- Status indication via LEDs

5.4.2 Wiring

X1: DI byte 0

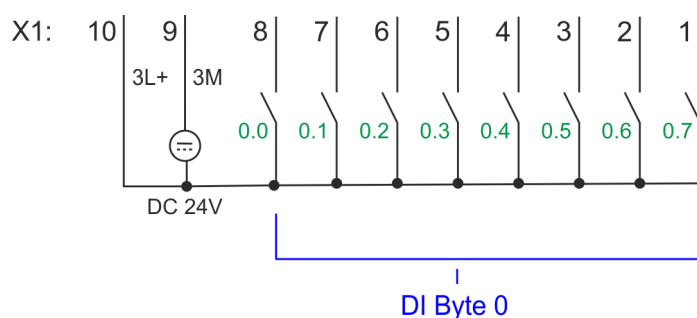

X1	Function	Type	LED ■ green	Description
1	DI 0.7	I	■	Digital input DI 7 / Counter 2 (B) / Frequency 2 *
2	DI 0.6	I	■	Digital input DI 6 / Counter 2 (A) *
3	DI 0.5	I	■	Digital input DI 5
4	DI 0.4	I	■	Digital input DI 4 / Counter 1 (B) / Frequency 1 *
5	DI 0.3	I	■	Digital input DI 3 / Counter 1 (A) *
6	DI 0.2	I	■	Digital input DI 2
7	DI 0.1	I	■	Digital input DI 1 / Counter 0 (B) / Frequency 0 *
8	DI 0.0	I	■	Digital input DI 0 / Counter 0 (A) *
9	0 V	I		3M: GND for onboard DI power section supply
10	DC 24V	I	■	3L+: DC 24V for onboard DI power section supply

*) Max. input frequency 100kHz otherwise 1kHz.

X5: DI byte 1

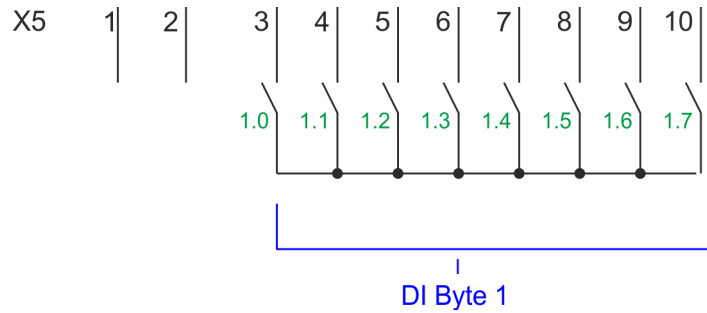

X5	Function	Type	LED green	Description
1	-	-		reserved
2	-	-		reserved
3	DI 1.0	I	■	Digital input DI 8
4	DI 1.1	I	■	Digital input DI 9 / Counter 3 (A) *
5	DI 1.2	I	■	Digital input DI 10 / Counter 3 (B) / Frequency 3 *
6	DI 1.3	I	■	Digital input DI 11 / Gate 3 *
7	DI 1.4	I	■	Digital input DI 12
8	DI 1.5	I	■	Digital input DI 13
9	DI 1.6	I	■	Digital input DI 14
10	DI 1.7	I	■	Digital input DI 15 / Latch 3 *

*) Max. input frequency 100kHz otherwise 1kHz.

5.4.3 Parametrization

5.4.3.1 Adress assignment

Sub module	Input address	Access	Description
DI24/DO16	136	BYTE	Digital input I+0.0 ... I+0.7 (X1)
	137	BYTE	Digital input I+1.0 ... I+1.7 (X5)

5.4.3.2 Hardware interrupt

Parameter hardware configuration

With the parameter *'Hardware interrupt at ...'* you can specify a hardware interrupt for each input for the corresponding edge. The hardware interrupt is disabled, if nothing is selected (default setting). A diagnostics interrupt is only supported with *Hardware interrupt lost*. Select with the arrow keys the input and enable the according hardware interrupts.

Here is valid:











- Rising edge: Edge 0-1
- Falling edge: Edge 1-0

5.4.3.3 Input delay









Parameter hardware configuration

- The input delay can be configured per channel in groups of 4.
- An input delay of 0.1ms is only possible with "fast" inputs, which have a max. input frequency of 100kHz ↪ *Chap. 5.4 'Digital input' page 111*. Within a group, the input delay for slow inputs is limited to 0.5ms.
- Range of values: 0.1ms / 0.5ms / 3ms / 15ms

5.4.4 Status indication

X1	Function	Type	LED  green	Description
1	DI 0.7	I		Digital input DI 7 / Counter 2 (B) / Frequency 2 *
2	DI 0.6	I		Digital input DI 6 / Counter 2 (A) *
3	DI 0.5	I		Digital input DI 5
4	DI 0.4	I		Digital input DI 4 / Counter 1 (B) / Frequency 1 *
5	DI 0.3	I		Digital input DI 3 / Counter 1 (A) *
6	DI 0.2	I		Digital input DI 2
7	DI 0.1	I		Digital input DI 1 / Counter 0 (B) / Frequency 0 *
8	DI 0.0	I		Digital input DI 0 / Counter 0 (A) *
9	0 V	I		3M: GND for onboard DI power section supply
10	DC 24V	I		3L+: DC 24V for onboard DI power section supply



*) Max. input frequency 100kHz otherwise 1kHz.

X5	Function	Type	LED  green	Description
1	-	-		reserved
2	-	-		reserved
3	DI 1.0	I		Digital input DI 8
4	DI 1.1	I		Digital input DI 9 / Counter 3 (A) *
5	DI 1.2	I		Digital input DI 10 / Counter 3 (B) / Frequency 3 *
6	DI 1.3	I		Digital input DI 11 / Gate 3 *
7	DI 1.4	I		Digital input DI 12
8	DI 1.5	I		Digital input DI 13
9	DI 1.6	I		Digital input DI 14
10	DI 1.7	I		Digital input DI 15 / Latch 3 *





*) Max. input frequency 100kHz otherwise 1kHz.

Digital input > Status indication



DI +x

Digital input	LED  green	Description
DI +0.0 DI +0.7		Digital I+0.0 ... 0.7 has "1" signal
	<input type="checkbox"/>	Digital I+0.0 ... 0.7 has "0" signal
DI +1.0 ... DI +1.7		Digital input I+1.0 ... 1.7 has "1" signal
	<input type="checkbox"/>	Digital input I+1.0 ... 1.7 has "0" signal

xL+

Power supply	LED  green	Description
1L+		DC 24V electronic section supply
	<input type="checkbox"/>	DC 24V electronic section supply not available
3L+		DC 24V power section supply inputs OK
	<input type="checkbox"/>	DC 24V power section supply inputs not available
4L+		DC 24V power section supply outputs OK
	<input type="checkbox"/>	DC 24V power section supply outputs not available

xF

Error	LED  green /  red	Description
4M		Error, overload respectively short circuit on the outputs
	<input type="checkbox"/>	no error

5.5 Digital output

5.5.1 Properties

- 12xDC 24V, 0.5A
- Status indication via LEDs

5.5.2 Wiring

X2: DO byte 0

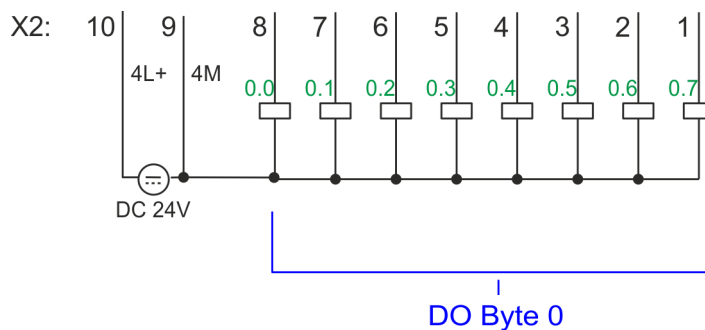

X2	Function	Type	LED ■ green	Description
1	DO 0.7	O	■	Digital output DO 7
2	DO 0.6	O	■	Digital output DO 6
3	DO 0.5	O	■	Digital output DO 5
4	DO 0.4	O	■	Digital output DO 4
5	DO 0.3	O	■	Digital output DO 3 / Output channel counter 3
6	DO 0.2	O	■	Digital output DO 2 / Output channel counter 2
7	DO 0.1	O	■	Digital output DO 1 / PWM 1 / Output channel counter 1
8	DO 0.0	O	■	Digital output DO 0 / PWM 0 / Output channel counter 0
9	0 V	I	■ red	4M: GND for onboard DO power section supply / GND PWM LED (red) is on at short circuit respectively overload
10	DC 24V	I	■	4L+: DC 24V for onboard DO power section supply











Digital output > Status indication

5.5.3 Parametrization



5.5.3.1 Address assignment

Sub module	Output address	Access	Description
DI24/DO16	136	BYTE	Digital output Q+0.0 ... Q+0.7 (X2)
	137	BYTE	Digital output Q+1.0 ... Q+1.3 (X6)

5.5.4 Status indication

X2	Function	Type	LED  green	Description
1	DO 0.7	O		Digital output DO 7
2	DO 0.6	O		Digital output DO 6
3	DO 0.5	O		Digital output DO 5
4	DO 0.4	O		Digital output DO 4
5	DO 0.3	O		Digital output DO 3 / Output channel counter 3
6	DO 0.2	O		Digital output DO 2 / Output channel counter 2
7	DO 0.1	O		Digital output DO 1 / PWM 1 / Output channel counter 1
8	DO 0.0	O		Digital output DO 0 / PWM 0 / Output channel counter 0
9	0 V	I	 red	4M: GND for onboard DO power section supply / GND PWM LED (red) is on at short circuit respectively overload
10	DC 24V	I		4L+: DC 24V for onboard DO power section supply

DO +x

Digital output	LED  green	Description
DO +0.0 ... DO +0.7		Digital output Q+0.0 ... 0.7 has "1" signal
	<input type="checkbox"/>	Digital output Q+0.0 ... 0.7 has "0" signal
DO +1.0 ... DO +1.3		Digital output Q+1.0 ... 1.3 has "1" signal
	<input type="checkbox"/>	Digital output Q+1.0 ... 1.3 has "0" signal

xL+

Power supply	LED <input checked="" type="checkbox"/> green	Description
1L+	<input checked="" type="checkbox"/>	DC 24V electronic section supply
	<input type="checkbox"/>	DC 24V electronic section supply not available
3L+	<input checked="" type="checkbox"/>	DC 24V power section supply inputs OK
	<input type="checkbox"/>	DC 24V power section supply inputs not available
4L+	<input checked="" type="checkbox"/>	DC 24V power section supply outputs OK
	<input type="checkbox"/>	DC 24V power section supply outputs not available

xF

Error	LED <input checked="" type="checkbox"/> green / <input checked="" type="checkbox"/> red	Description
4M	<input checked="" type="checkbox"/>	Error, overload respectively short circuit on the outputs
	<input type="checkbox"/>	no error

5.6 Counting

5.6.1 Properties

- 4 channels
- Various counting modes
 - once
 - continuously
 - periodically
- Control by the user program via blocks

5.6.2 Wiring

5.6.2.1 Counter inputs

X1: DI byte 0

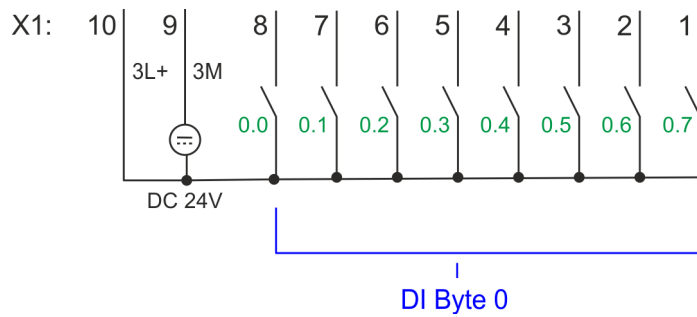

X1	Function	Type	LED green	Description
1	DI 0.7	I	■	Counter 2 (B) *
2	DI 0.6	I	■	Counter 2 (A) *
4	DI 0.4	I	■	Counter 1 (B) *
5	DI 0.3	I	■	Counter 1 (A) *
7	DI 0.1	I	■	Counter 0 (B) *
8	DI 0.0	I	■	Counter 0 (A) *
9	0 V	I		3M: GND for counter
10	DC 24V	I	■	3L+: DC 24V power section supply for counter

*) Max. input frequency 100kHz otherwise 1kHz.

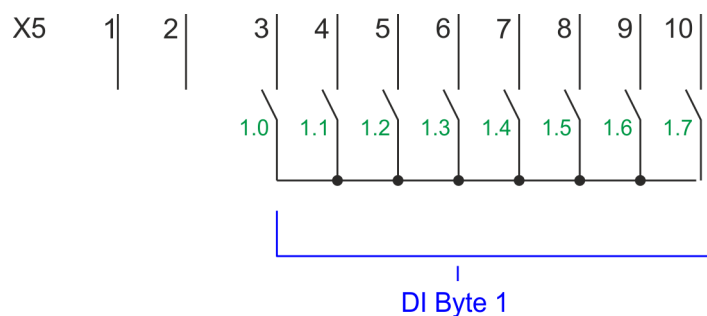
X5: DI byte 1

X5	Function	Type	LED ■ green	Description
4	DI 1.1	I	■	Counter 3 (A) *
5	DI 1.2	I	■	Counter 3 (B) *
6	DI 1.3	I	■	Gate 3 *
10	DI 1.7	I	■	Latch 3 *

*) Max. input frequency 100kHz otherwise 1kHz.

Input signals

The following sensors can be connected

- 24V incremental encoders with two phase-shifted by 90° tracks
- 24V pulse encoder with direction signal
- 24V initiator as BERO or beam sensor

For not all inputs are available at the same time, for every counter you may define the input assignment via the parameterization for the following input signals:

- *Counter_x (A)*
 - Pulse input for counter signal respectively track A of an encoder for 1-, 2- or 4-fold evaluation.
- *Counter_x (B)*
 - Direction signal respectively track B of the encoder. Via the parameterization you may invert the direction signal.
- *Gate 3*
 - Via this input you can if parameterized open the HW gate of *Counter 3* with edge 0-1 and start counting.
- *Latch 3*
 - Via this input via edge 0-1 the current counter value of *Counter 3* is stored in a memory that you may read if needed.

5.6.2.2 Counter outputs

X2: DO byte 0

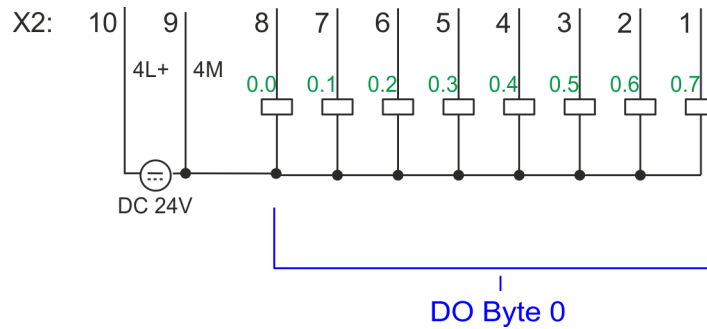

X2	Function	Type	LED green / red	Description
5	DO 0.3	O	green	Output channel counter 3
6	DO 0.2	O	green	Output channel counter 2
7	DO 0.1	O	green	Output channel counter 1
8	DO 0.0	O	green	Output channel counter 0
9	0 V	I	red	4M: GND for output channel counter LED (red) is on at short circuit respectively overload
10	DC 24V	I	green	4L+: DC 24V power section supply for output channel counter

Output channel Counter_x

Every counter has an assigned output channel. For each counter you can specify the behavior of the counter output via the parametrization with 'Characteristics of the output' and 'Pulse duration'. ↪ Chap. 5.6.4.3 'Counter' page 122

5.6.3 Proceeding

Hardware configuration

In the Siemens SIMATIC Manager the following steps should be executed:

1. ➤ Perform a hardware configuration for the CPU. ↪ Chap. 4.4 'Hardware configuration - CPU' page 68
2. ➤ Double-click the counter sub module of the CPU 314C-2 PN/DP (314-6EH04-0AB0 V3.3).
⇒ The dialog 'Properties' is opened.
3. ➤ As soon as you select the operating mode for the corresponding channel, a dialog box with default values for this counter mode is created and shown.
4. ➤ Perform the required parameter settings.
5. ➤ Save your project with 'Station → Safe and compile'.
6. ➤ Transfer your project to your CPU.

User program

- The SFB 47 should cyclically be called (e.g. OB 1) for controlling the counter functions.
- The SFB is to be called with the corresponding instance DB. Here the parameters of the SFB are stored.

- Among others the SFB 47 contains a request interface. Hereby you get read and write access to the registers of the appropriate counter.
- So that a new job may be executed, the previous job must have be finished with `JOB_DONE = TRUE`.
- Per channel you may call the SFB in each case with the same instance DB, since the data necessary for the internal operational are stored here.
- Writing accesses to outputs of the instance DB is not permissible.
- Starting, stopping and interrupting a count function of *Counter 0* to *Counter 2* exclusively happens via the SW gate by setting the SW gate of the SFB 47.
You can also activate input 'Gate 3' via the parametrization for *Counter 3*.



More information about the usage of this block may be found in the manual "SPEED7 Operation List" from VIPA.

5.6.4 Parametrization

5.6.4.1 Address assignment

Sub module	Input address	Access	Description
<i>Counter</i>	816	DINT	Channel 0: Counter value
	820	DINT	Channel 1: Counter value
	824	DINT	Channel 2: Counter value
	828	DINT	Channel 3: Counter value

Sub module	Output address	Access	Description
<i>Counter</i>	816	DWORD	reserved
	820	DWORD	reserved
	824	DWORD	reserved
	828	DWORD	reserved

5.6.4.2 Interrupt selection

Via 'Basic parameters' you can reach 'Select interrupt'. Here you can define the interrupts the CPU will trigger. The following parameters are supported:

- None: The interrupt function is disabled.
- Process: The following events of the counter can trigger a hardware interrupt (selectable via 'Count'):
 - Hardware gate opening
 - Hardware gate closing
 - On reaching the comparator
 - on Counting pulse
 - on overflow
 - on underflow
- Diagnostics+process: A diagnostics interrupt is only triggered when a hardware interrupt was lost.

5.6.4.3 Counter

Parameter hardware configuration

Default values and structure of this dialog box depend on the selected 'Operating mode'.



Please consider that the range of values could be limited due to the used projecting tool. With the VIPA SPEED7 Studio there are no limitations.
 ↪ Chap. 10 'Configuration with VIPA SPEED7 Studio' page 225

Parameter overview

Operating parameters	Description	Assignment
Main count direction	<ul style="list-style-type: none"> ■ <i>None</i> No restriction of the counting range ■ <i>Up</i>: Restricts the up-counting range. The counter starts from 0 or <i>load value</i>, counts in positive direction up to the declaration <i>end value</i> -1 and then jumps back to <i>load value</i> at the next positive transducer pulse. ■ <i>Down</i>: Restricts the down-counting range. The counter starts from the declared <i>start value</i> or <i>load value</i> in negative direction, counts to 1 and then jumps to <i>start value</i> at the next negative encoder pulse. Function is disable with <i>count continuously</i>. 	<ul style="list-style-type: none"> ■ None
Gate function	<ul style="list-style-type: none"> ■ <i>Cancel count</i>: The count starts when the gate opens and resumes at the <i>load value</i> when the gate opens again. ■ <i>Stop count</i>: The count is interrupted when the gate closes and resumed at the last actual counter value when the gate opens again. <p>↪ Chap. 5.6.6.2 'Gate function' page 133</p>	Abort count process
Start value	<i>Start value</i> with counting direction backward.	2147483647 (2 ³¹ -1)
End value	<i>End value</i> with main counting direction forward. Range of values: 2...2147483647 (2 ³¹ -1)	

Operating parameters	Description	Assignment
Comparison value	<p>The count value is compared with the <i>comparison value</i>. See also the parameter "Characteristics of the output":</p> <ul style="list-style-type: none"> ■ No main counting direction <ul style="list-style-type: none"> – Range of values: -2^{31} to $+2^{31}-1$ ■ Main counting direction forward <ul style="list-style-type: none"> – Range of values: -2^{31} to end value-1 ■ Main counting direction backward <ul style="list-style-type: none"> – Range of values: 1 to $+2^{31}-1$ 	0
Hysteresis	<p>The <i>hysteresis</i> serves the avoidance of many toggle processes of the output, if the counter value is in the range of the <i>comparison value</i>.</p> <p>0, 1: <i>Hysteresis</i> disabled</p> <p>Range of values: 0 to 255</p>	0
Input	Description	Assignment
Signal evaluation	<p>Specify the signal of the connected encoder:</p> <ul style="list-style-type: none"> ■ Pulse/direction At the input count and direction signal are connected ■ At the input there is an encoder connected with the following evaluation: <ul style="list-style-type: none"> – Rotary encoder single – Rotary encoder double – Rotary encoder quadruple 	Pulse/direction
Hardware gate	<p>Gate control exclusively via channel 3:</p> <ul style="list-style-type: none"> ■ enabled: The gate control for channel 3 happens via SW and HW gate ■ disabled: The gate control for channel 3 exclusively happens via SW gate <p>🔗 <i>Chap. 5.6.6.2 'Gate function' page 133</i></p>	disabled
Count direction inverted	<p>Invert the input signal '<i>Direction</i>':</p> <ul style="list-style-type: none"> ■ enabled: The input signal is inverted ■ disabled: The input signal is not inverted 	disabled

Output	Description	Assignment
Characteristics of the output	<p>The output and the "Comparator" (STS_CMP) status bit are set, dependent on this parameter.</p> <ul style="list-style-type: none"> ■ No comparison: The output is used as normal output and STS_CMP remains reset. ■ Comparator <ul style="list-style-type: none"> – Counter value \geq Comparison value – Counter value \leq Comparison value ■ Pulse at <i>comparison value</i> <ul style="list-style-type: none"> – To adapt the used actuators you can specify a <i>pulse duration</i>. The output is set for the specified <i>pulse duration</i> when the counter value reaches the <i>comparison value</i>. When you've set a main counting direction the output is only set at reaching the <i>comparison value</i> from the main counting direction. 	No comparison
Pulse duration	<p>Here you can specify the <i>pulse duration</i> for the output signal.</p> <ul style="list-style-type: none"> ■ The <i>pulse duration</i> starts with the setting of the according digital output. ■ The inaccuracy of the <i>pulse duration</i> is less than 1ms. ■ There is no past triggering of the <i>pulse duration</i> when the <i>comparison value</i> has been left and reached again during pulse output. ■ If the <i>pulse duration</i> is changed during operation, it will take effect with the next pulse. ■ If the <i>pulse duration</i> = 0, the output is set until the comparison condition is not longer fulfilled. <p>Range of values: 0...510ms in steps of 2ms</p>	0
Hardware interrupt	Description	Assignment
Hardware gate opening	<p>Hardware interrupt by edge 0-1 exclusively at HW gate channel 3</p> <ul style="list-style-type: none"> ■ enabled: Process interrupt by edge 0-1 exclusively at HW gate channel 3 with open SW gate ■ disabled: no hardware interrupt 	disabled
Hardware gate closing	<p>Hardware interrupt by edge 1-0 exclusively at HW gate channel 3</p> <ul style="list-style-type: none"> ■ enabled: Process interrupt by edge 1-0 exclusively at HW gate channel 3 with open SW gate ■ disabled: no hardware interrupt 	disabled
On reaching comparator	<p>Hardware interrupt on reaching <i>comparator</i></p> <ul style="list-style-type: none"> ■ enabled: Hardware interrupt when comparator is triggered, can be configured via '<i>Characteristics of the output</i>' ■ disabled: no hardware interrupt 	disabled

Hardware interrupt	Description	Assignment
Overflow	Hardware interrupt overflow <ul style="list-style-type: none"> ■ enabled: Hardware interrupt on overflow the upper counter limit ■ disabled: no hardware interrupt 	disabled
Underflow	Hardware interrupt on underrun <ul style="list-style-type: none"> ■ enabled: Hardware interrupt on underflow the lower counter limit ■ disabled: no hardware interrupt 	disabled

Max. frequency	Description	Assignment	
Counting signals/HW gate	Specify the max. frequency for track A/pulse, track B/direction and HW gate	60kHz	
	Frequency		shortest permissible count pulse
	1kHz		400µs
	2kHz		200µs
	5kHz		80µs
	10kHz		40µs
	30kHz		13µs
	60kHz		6.7µs
Latch	Specify the max. frequency for the latch signal	10kHz	
	Frequency		shortest permissible Latch pulse
	1kHz		400µs
	2kHz		200µs
	5kHz		80µs
	10kHz		40µs
	30kHz		13µs
	60kHz		6.7µs

5.6.5 Counter operating modes

5.6.5.1 Count continuously

- In this operating mode the counter counts starting with the *load value*.
- When the counter counts forward and reaches the upper count limit and another counting pulse in positive direction arrives, it jumps to the lower count limit and counts from there on.
- When the counter counts backwards and reaches the lower count limit and another counting pulse in negative direction arrives, it jumps to the upper count limit and counts from there on.
- The counter limits are fix set to maximum range.
- With overflow or underflow the status bits STS_OFLW respectively STS_UFLW in the SFB 47 are set. These bits remain set until these are reset with RES_STS. If enabled additionally a hardware interrupt is triggered.

Limits	Valid range of values
Lower count limit	-2 147 483 648 (-2^{31})
Upper count limit	+2 147 483 647 ($2^{31} - 1$)

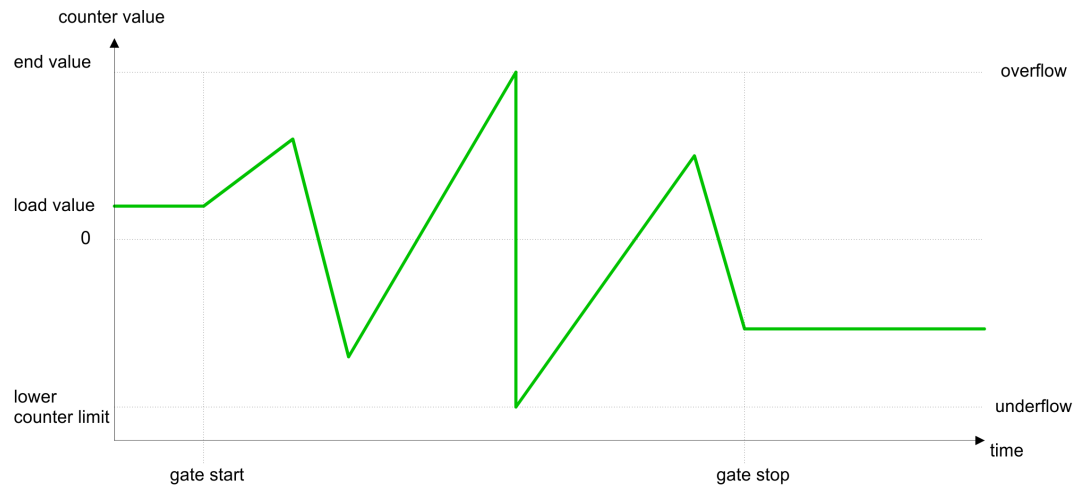

5.6.5.2 Count once

5.6.5.2.1 No main counting direction

- The counter counts once starting with *load value*.
- It is counted forward or backward.
- The counter limits are fix set to maximum range.
- At over- or underflow at the count limits, the counter jumps to the according other count limit and the gate is automatically closed.
- To restart the count process, you have to generate an edge 0-1 at the gate ↪ Chap. 5.6.6.2 'Gate function' page 133.
- With the configured 'Gate function' 'Interrupt count' the counting is continued with current *Counter value*.
- With configured 'Gate function' 'Cancel count' the counter starts with the *Load value*.

Limits	Valid range of values
Lower count limit	-2 147 483 648 (-2^{31})
Upper count limit	+2 147 483 647 ($2^{31} - 1$)

Interrupting gate control

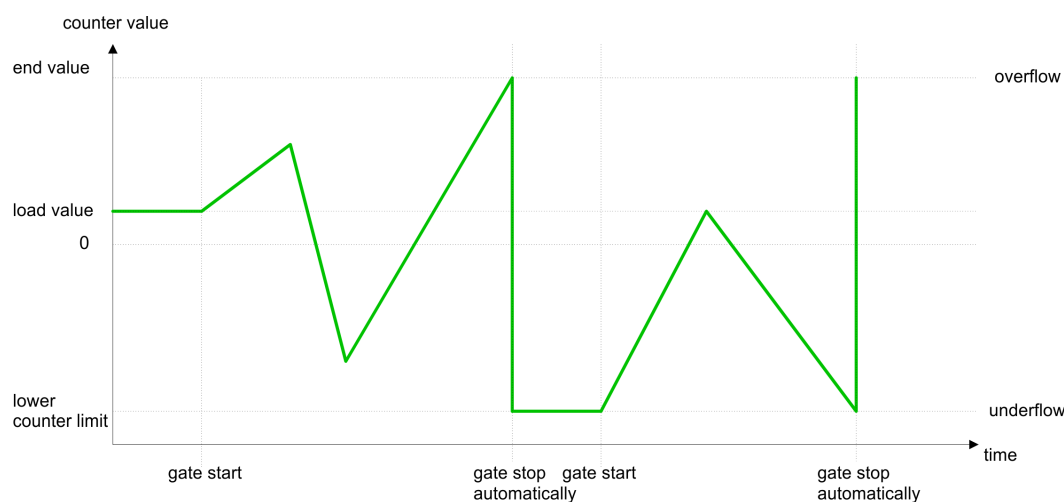

Aborting gate control



5.6.5.2.2 Main counting direction forward

- The counter counts forward starting with the *load value*.
- When the counter reaches the *End value* -1 in positive direction, it jumps to the *load value* at the next count pulse and the gate is automatically closed.
- To restart the count process, you have to generate an edge 0-1 at the gate ↪ *Chap. 5.6.6.2 'Gate function' page 133*. The counter counts starting with the *load value*.
- You may exceed the lower count limit.

Limits	Valid range of values
End value	-2 147 483 647 ($-2^{31} + 1$) up to +2 147 483 647 ($2^{31} - 1$)
Lower count limit	-2 147 483 648 (-2^{31})

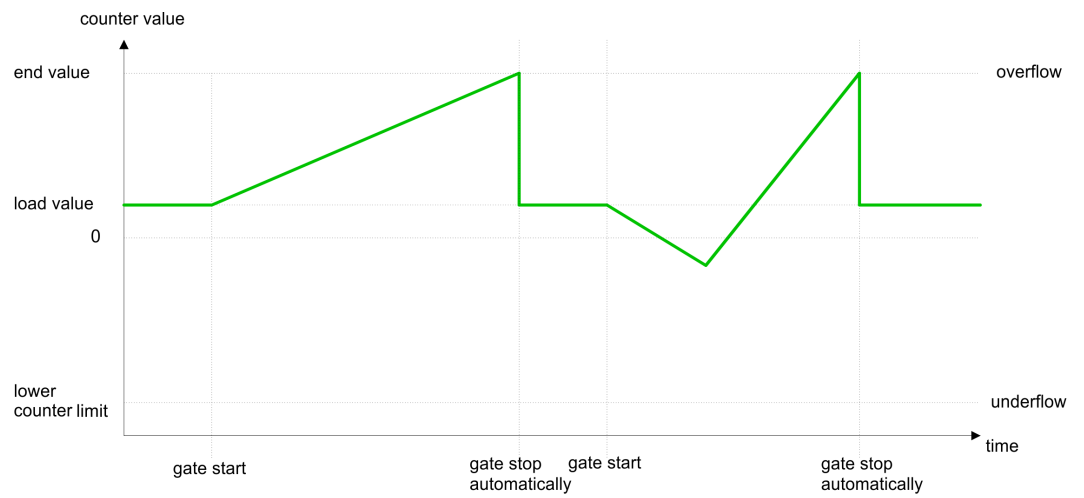

5.6.5.2.3 Main counting direction backward

- The counter counts backward starting with the *load value*.
- When the counter reaches the *End value* +1 in positive direction, it jumps to the *load value* at the next count pulse and the gate is automatically closed.
- To restart the count process, you have to generate an edge 0-1 at the gate ↪ Chap. 5.6.6.2 'Gate function' page 133. The counter counts starting with the *load value*.
- You may exceed the upper count limit.

Limits	Valid range of values
End value	-2 147 483 648 (-2^{31}) up to +2 147 483 646 ($2^{31} - 2$)
Upper count limit	+2 147 483 647 ($2^{31} - 1$)

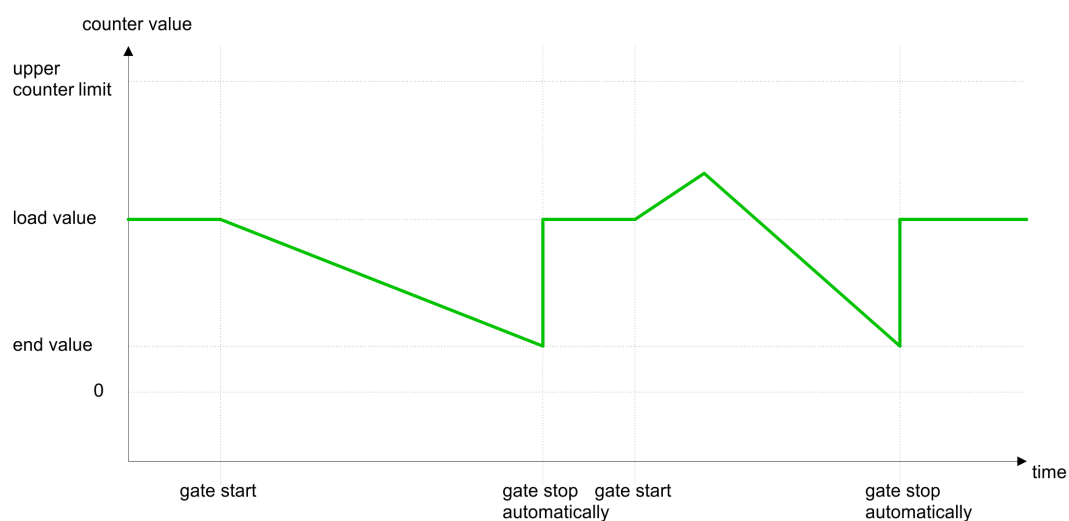

5.6.5.3 Count periodically

5.6.5.3.1 No main counting direction

- The counter counts forward or backwards starting with the *load value*.
- At over- or underrun at the count limits, the counter jumps to the *load value* and continues counting. If enabled additionally a hardware interrupt is triggered.
- The counter limits are fix set to maximum range.

Limits	Valid range of values
Lower count limit	-2 147 483 648 (-2^{31})
Upper count limit	+2 147 483 647 ($2^{31} - 1$)



5.6.5.3.2 Main counting direction forward

- The counter counts forward starting with the *load value*.
- When the counter reaches the end value -1 in positive direction, it jumps to the *load value* at the next positive count pulse and continues counting. If enabled additionally a hardware interrupt is triggered.
- You may exceed the lower count limit.

Limits	Valid range of values
End value	-2 147 483 647 ($-2^{31} + 1$) up to +2 147 483 647 ($2^{31} - 1$)
Lower count limit	-2 147 483 648 (-2^{31})

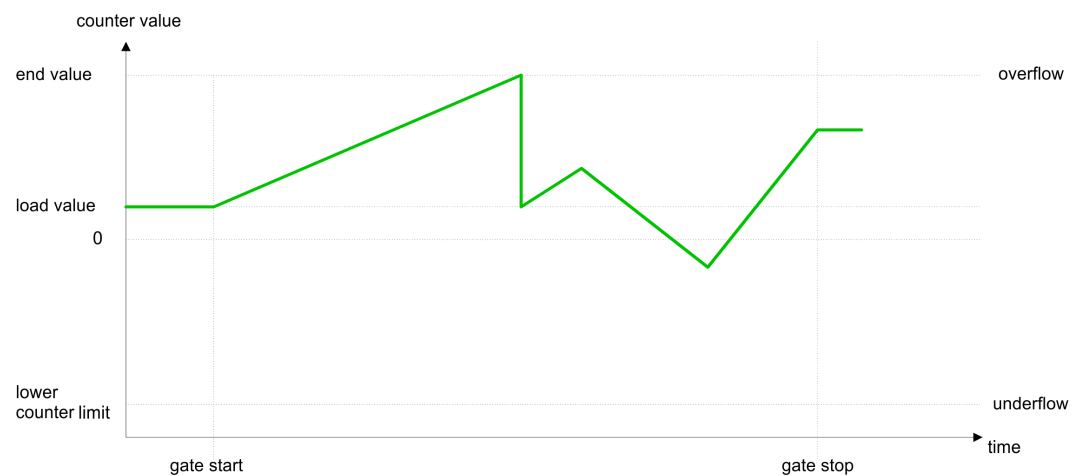

5.6.5.3.3 Main counting direction backward

Main counting direction backward

- The counter counts backward starting with the *load value*.
- When the counter reaches the *end value* +1 in positive direction, it jumps to the *load value* at the next negative count pulse and continues counting. If enabled additionally a hardware interrupt is triggered.
- You may exceed the upper count limit.

Limits	Valid range of values
End value	-2 147 483 648 (-2^{31}) up to +2 147 483 646 ($2^{31} - 2$)
Upper count limit	+2 147 483 647 ($2^{31} - 1$)

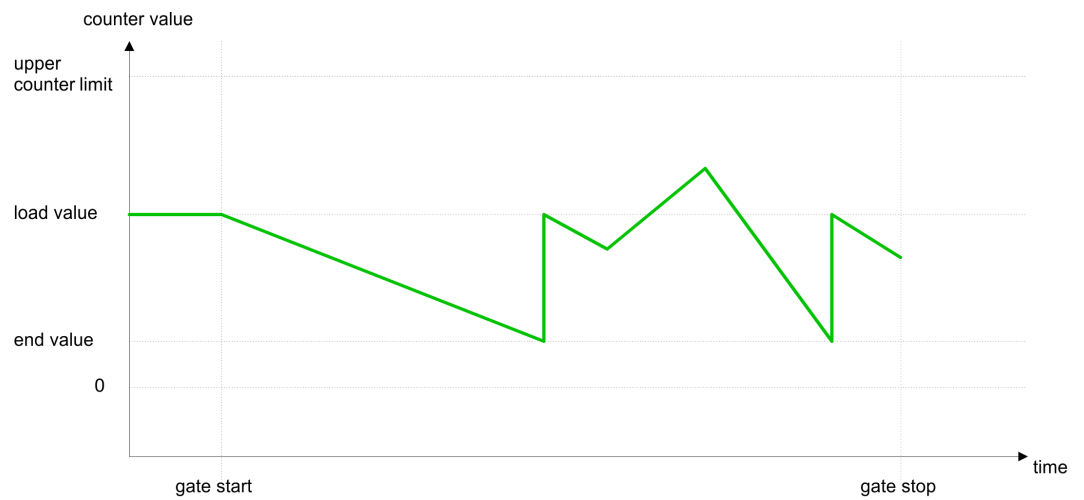

5.6.6 Counter - Additional functions

5.6.6.1 Overview

Schematic structure

The illustration shows how the additional functions influence the counting behavior. The following pages describe these additional functions in detail:

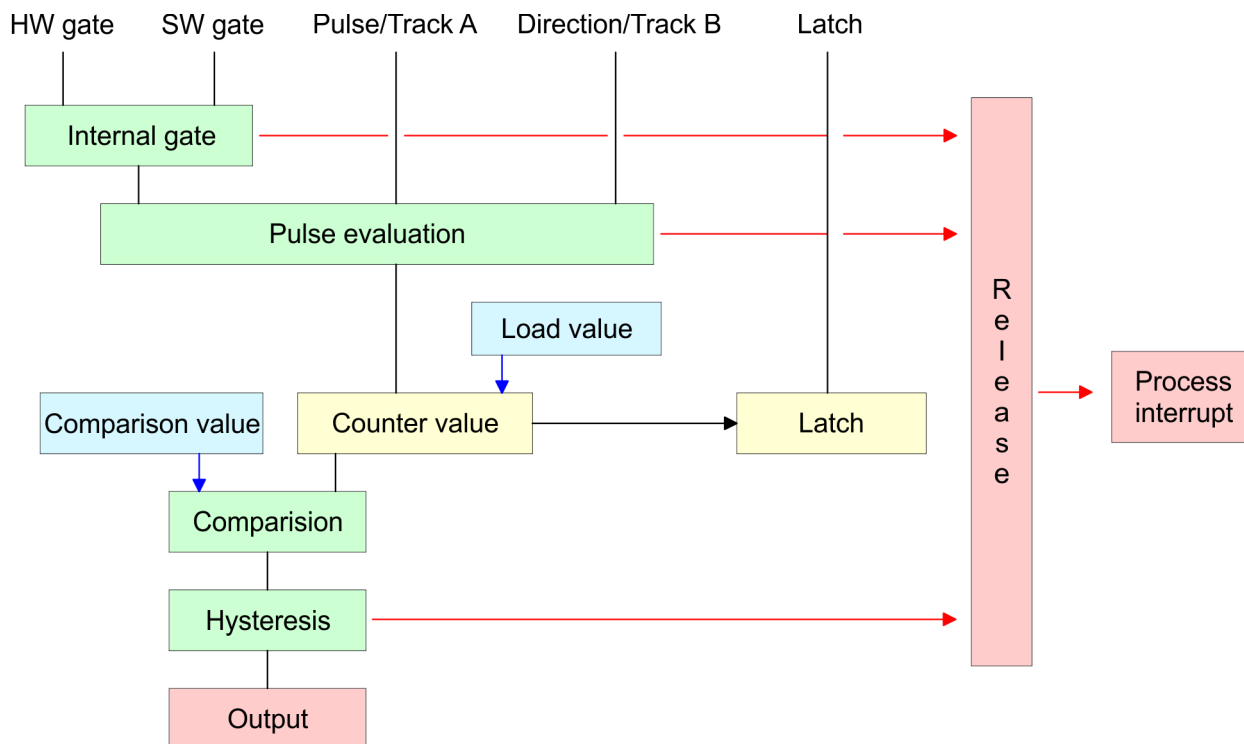

5.6.6.2 Gate function

Function

- Starting, stopping and interrupting a count function of *counter 0* to *counter 2* exclusively happens via the SW gate by setting the SW gate of SFB 47.
- Starting, stopping and interrupting a count function of *counter 3* happens via the internal gate (I gate). The I gate is the result of logic operation of HW gate and SW gate. The HW gate evaluation of the connection 'Gate 3' may be deactivated by the parametrization. With a de-activated HW gate evaluation the triggering exclusively happens by setting the SW gate of SFB 47.

Gate function abort and interrupt

The parametrization defines if the gate interrupts or aborts the counter process.

- At *abort function* the counter starts counting with the *load value* after gate restart.

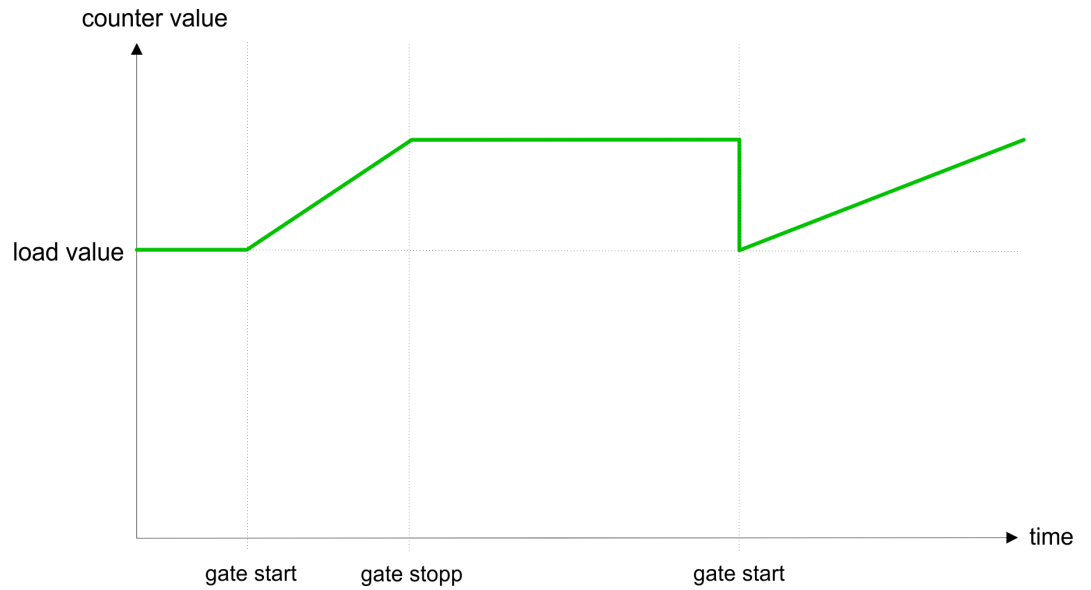

- At *interrupt function*, the counter starts counting with the last recent counter value after gate restart.

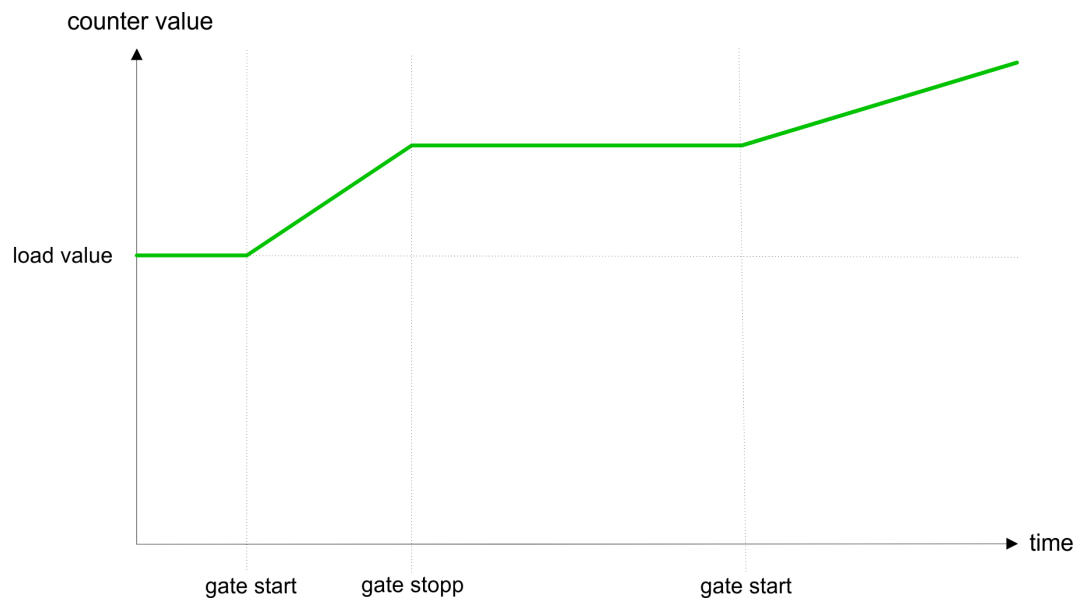

Counter 0 ... 2

SW gate	Gate function	Reaction counter 0 ... 2
Edge 0-1	Abort count process	Restart with <i>load value</i>
Edge 0-1	Interrupt count process	Continue

5.6.6.3 Comparator

Function

In the CPU a *comparison value* may be stored. During the counting procedure the counter value is compared with the *comparative value*. Depending on the result of the comparison the output channel of the counter and the status bit of STS_CMP of SFB 47 can be set. In addition, you can configure a hardware interrupt. A *comparison value* can be specified via the parametrization respectively the job interface of SFB 47.

5.6.6.4 Additional functions counter 3

Exclusively counter 3 has the following additional functions:

- HW gate via *Gate 3*
- Latch function

5.6.6.4.1 HW gate via *Gate 3*

Starting, stopping and interrupting a count function of counter 3 happens via the internal gate (I gate). The i gate is the result of logic operation of HW gate and SW gate. The HW gate evaluation of the connection '*Gate 3*' may be deactivated by the parametrization. With a de-activated HW gate evaluation the triggering exclusively happens by setting the SW gate of the SFB 47.

Counter 3:

SW gate	HW gate	Gate function	Reaction counter 3:
Edge 0-1	de-activated	Abort count process	Restart with load value
Edge 0-1	de-activated	Interrupt count process	Continue
Edge 0-1	1	Abort count process	Continue
1	Edge 0-1	Abort count process	Restart with load value
Edge 0-1	1	Interrupt count process	Continue
1	Edge 0-1	Interrupt count process	Continue

Counter 3 - count once

If the internal gate has been closed automatically it may only be opened again under the following conditions:

SW gate	HW gate	I gate
1	Edge 0-1	1
Edge 0-1 (after edge 0-1 at HW gate)	Edge 0-1	1

5.6.6.4.2 Latch function

Function

- As soon as during a count process an edge 0-1 is recognized at the "Latch" input of counter 3, the current counter value is stored in the according latch register.
- You may access the latch value via the parameter LATCHVAL of the SFB 47.
- A just in LATCHVAL loaded value remains after a STOP-RUN transition.

5.6.6.5 Counter output channel

Characteristics of the output

Each counter has an output channel. You pre-define the behavior of the counter output via the parametrization:

- no comparison:
 - The output is used as normal output.
 - SFB 47:
 - The input parameter CTRL_DO is effect less.
 - The status bits STS_DO and STS_CMP (status comparator in the instance DB) remain reset.
- Counter value \geq comparison value respectively counter value \leq comparison value
 - The output remains set as long as the counter value is higher or equal *comparison value* respectively lower or equal *comparison value*.
 - SFB 47:
 - Control bit CTRL_DO must be set.
 - The comparison result is shown by the status bit STS_CMP. This status bit may only be reset if the comparison condition is no longer fulfilled.
- Pulse at comparison value
 - When the counter reaches the *comparison value* the output is set for the parametrized *pulse duration*. When you've set a main counting direction the output is only set at reaching the *comparison value* from the main counting direction.
 - If the *pulse duration* = 0, the output is set until the comparison condition is not longer fulfilled.
 - SFB 47:
 - Control bit CTRL_DO must be set.
 - The status of the digital output may be shown by the status bit ST_DO.
 - The comparison result is shown by the status bit STS_CMP. The bit may only be reset if the *pulse duration* has expired.
- Pulse duration
 - The *pulse duration* starts with the setting of the according digital output.
 - The inaccuracy of the *pulse duration* is less than 1ms.
 - There is no past triggering of the *pulse duration* when the *comparison value* has been left and reached again during pulse output.
 - If the *pulse duration* is changed during operation, it will take effect with the next pulse.
 - If the *pulse duration* = 0, the output is set until the comparison condition is not longer fulfilled.
 - Range of values: 0...510ms in steps of 2ms

5.6.6.6 Hysteresis function

Hysteresis

- The *hysteresis* serves the avoidance of many toggle processes of the output and the interrupt, if the *counter value* is in the range of the *comparison value*.
- For the *hysteresis* you may set a range of 0 to 255.
- The settings 0 and 1 deactivate the *hysteresis*.
- The *hysteresis* influences zero run, comparison, over- and underflow.
- An activated *hysteresis* remains active after a change. The new *hysteresis* range is activated with the next *hysteresis* event.

The following pictures illustrate the output behavior for *hysteresis* 0 and *hysteresis* 3 for the according conditions:

Effect at counter value \geq comparison value

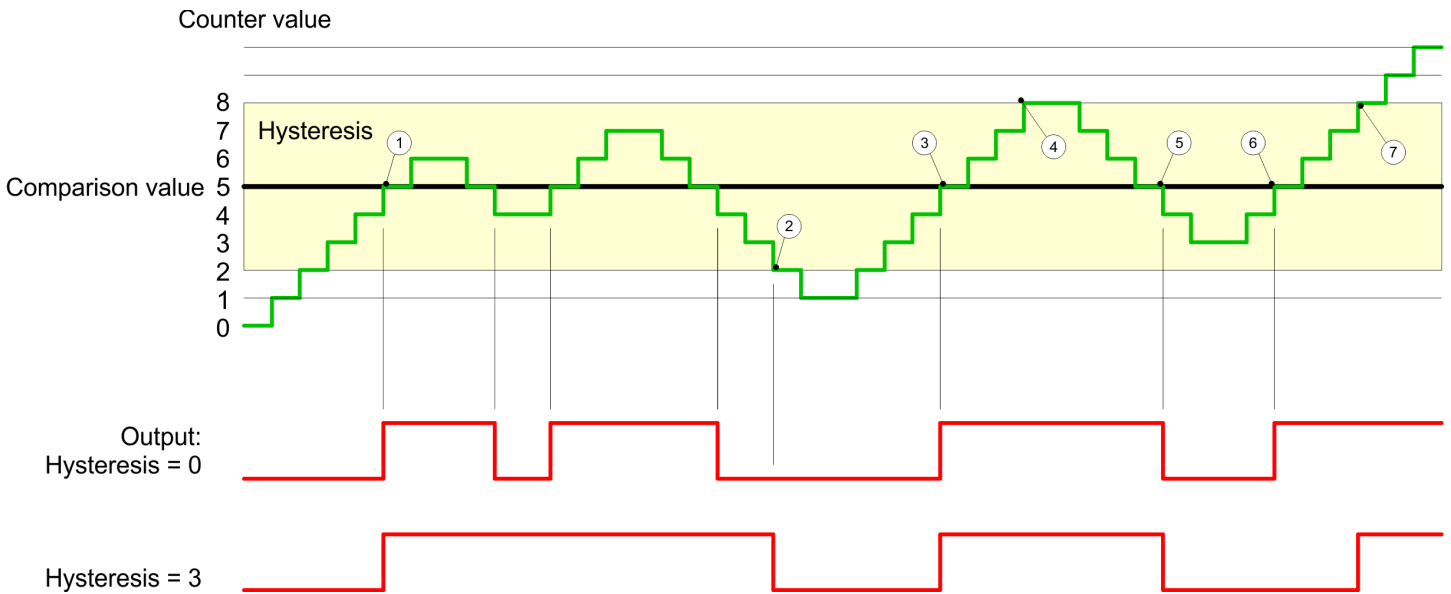

- 1 Counter value \geq comparison value \rightarrow output is set and *hysteresis* activated
- 2 Leave *hysteresis* range \rightarrow output is reset
- 3 Counter value \geq comparison value \rightarrow output is set and *hysteresis* activated
- 4 Leave *hysteresis* range, output remains set for counter value \geq comparison value
- 5 counter value $<$ comparison value and *hysteresis* active \rightarrow output is reset
- 6 counter value \geq comparison value \rightarrow output is not set for *hysteresis* active
- 7 Leave *hysteresis* range, output remains set for counter value \geq comparison value

With reaching the comparison condition the *hysteresis* gets active. At active *hysteresis* the comparison result remains unchanged until the *counter value* leaves the set *hysteresis* range. After leaving the *hysteresis* range a new *hysteresis* is only activated with again reaching the comparison conditions.

Effect at pulse at comparison value with pulse duration Zero

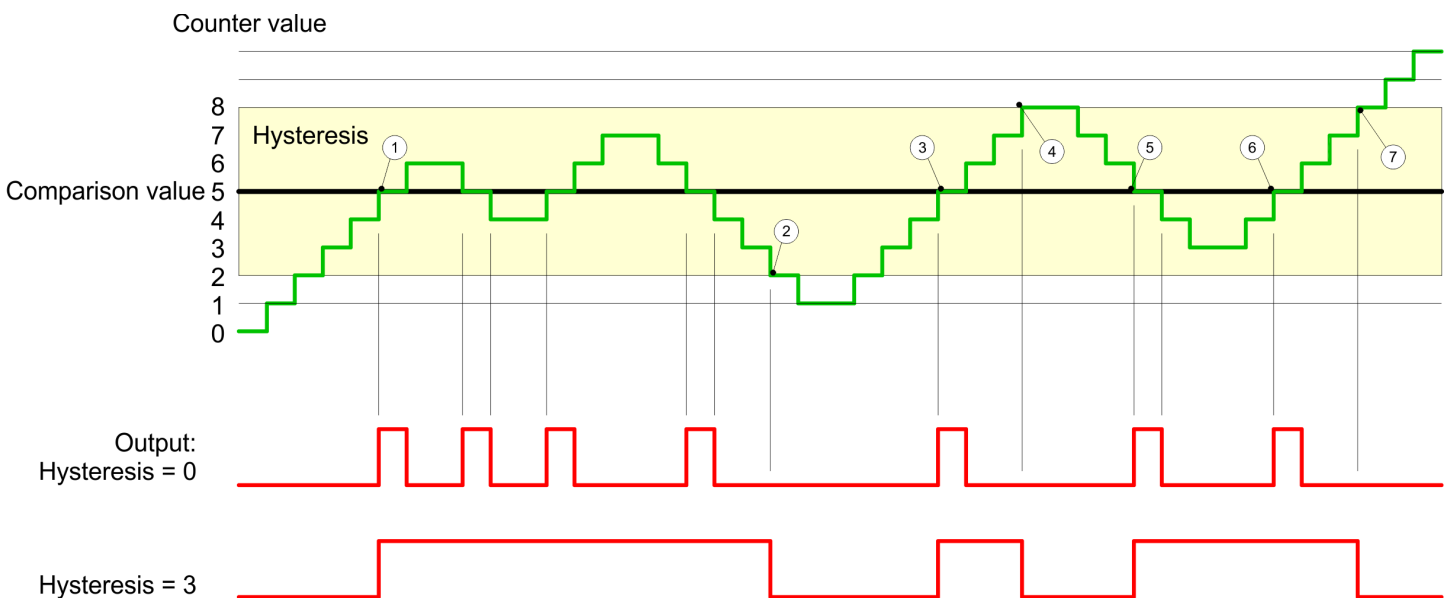

- 1 Counter value = comparison value \rightarrow output is set and *hysteresis* activated
- 2 Leave *hysteresis* range \rightarrow output is reset and counter value $<$ comparison value

- 3 Counter value = comparison value → output is set and hysteresis activated
- 4 Output is reset for leaving hysteresis range and counter value > comparison value
- 5 Counter value = comparison value → output is set and hysteresis activated
- 6 Counter value = comparison value and hysteresis active → output remains set
- 7 Leave hysteresis range and counter value > comparison value → output is reset

With reaching the comparison condition the hysteresis gets active. At active hysteresis the comparison result remains unchanged until the counter value leaves the set hysteresis range. After leaving the hysteresis range a new hysteresis is only activated with again reaching the comparison conditions.

Effect at pulse at comparison value with pulse duration not zero

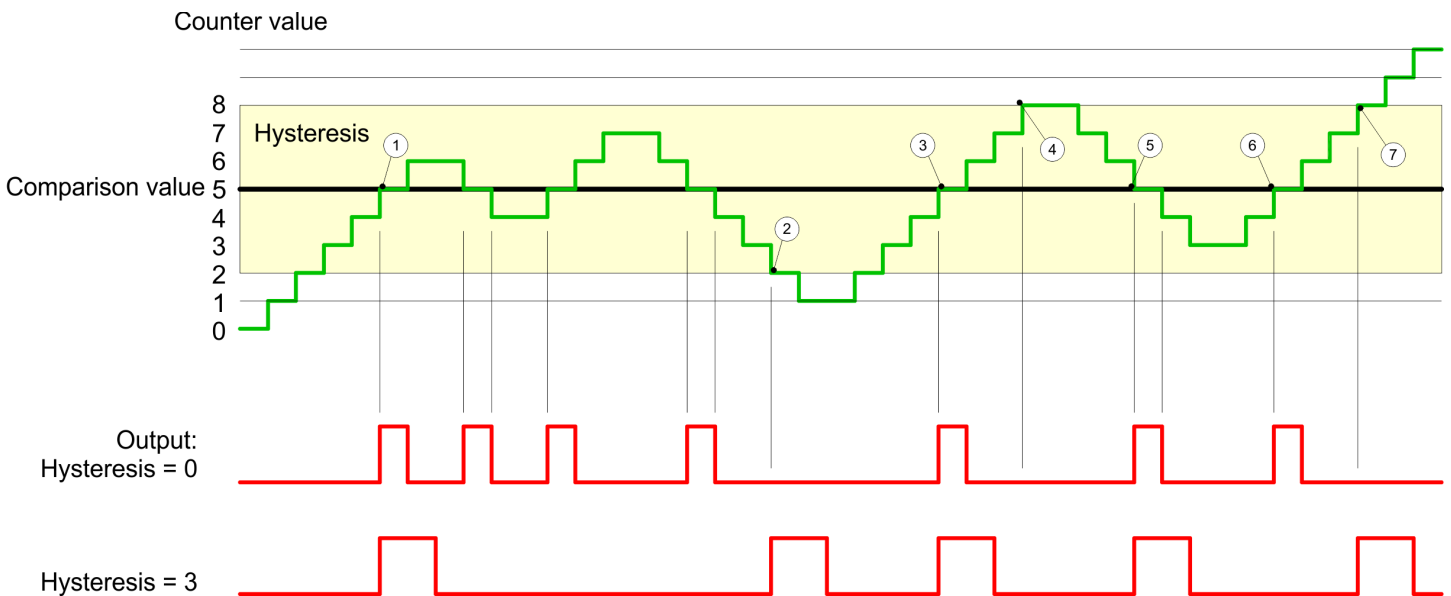

- 1 Counter value = comparison value → pulse of the parameterized pulse duration is put out, the hysteresis is activated and the counting direction stored
- 2 Leaving the hysteresis range contrary to the stored counting direction → pulse of the parameterized pulse duration is put out, the hysteresis is de-activated
- 3 Counter value = comparison value → pulse of the parameterized pulse duration is put out, the hysteresis is activated and the counting direction stored
- 4 Leaving the hysteresis range without changing counting direction → hysteresis is de-activated
- 5 Counter value = comparison value → pulse of the parameterized pulse duration is put out, the hysteresis is activated and the counting direction stored
- 6 Counter value = comparison value and hysteresis active → no pulse
- 7 Leaving the hysteresis range contrary to the stored counting direction → pulse of the parameterized pulse duration is put out, the hysteresis is de-activated

With reaching the comparison condition the hysteresis gets active and a pulse of the parameterized duration is put out. As long as the counter value is within the hysteresis range, no other pulse is put out. With activating the hysteresis the counting direction is stored in the module. If the counter value leaves the hysteresis range contrary to the stored counting direction, a pulse of the parameterized duration is put out. Leaving the hysteresis range without direction change, no pulse is put out.

5.6.7 Diagnostics and interrupt

Overview

GSDML

- Edge at an digital interrupt input

Via the hardware configuration you can define the following trigger for a hardware interrupt that can trigger a diagnostics interrupt:

- Reaching the comparison value
- Overflow respectively at overrun upper counter limit
- Underflow respectively at underrun lower counter limit
- Opening the HW gate with open SW gate - except for counter 3
- Closing the HW gate with open SW gate - except for counter 3

5.7 Frequency measurement

5.7.1 Properties

- In this operating mode the CPU counts the incoming pulses during a specified integration time and outputs them as frequency value.
- Integration time 10ms ... 10000ms in steps of 1ms configurable
- Control by the user program via SFB 48



More information about the usage of this block may be found in the manual "SPEED7 Operation List" from VIPA.

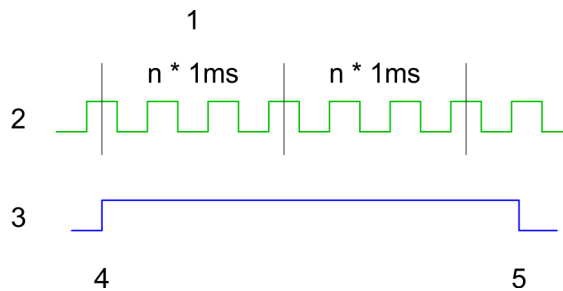

- 1 Integration time
- 2 Counting pulse
- 3 SW gate
- 4 Frequency measurement start
- 5 Frequency measurement stop

Measuring procedure

- The measurement is carried out during the integration time and is updated after the integration time has expired.
- If the period of the measured frequency exceeds the assigned integration time, this means there was no edge 0-1 during the measurement, the measurement value 0 is returned.
- The calculated frequency value is supplied in "mHz" units.
- The measurement value can be read with *MEAS_VAL* from SFB 48.
- As long as the SW gate is open, you can request the calculated frequency.
- The number of activated channels does not influence the max. frequency, which is defined in the technical data.

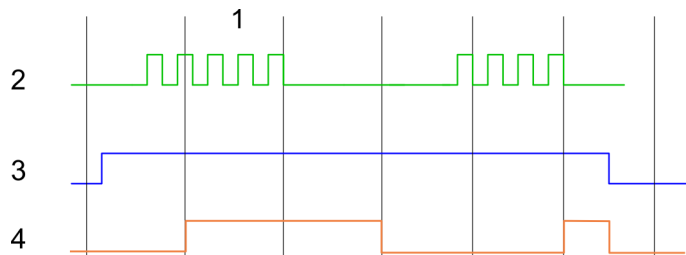

- 1 Integration time
- 2 Counting pulse
- 3 SW gate
- 4 Evaluated frequency



The counting function is disabled during the pulse width modulation on the same channel.

5.7.2 Wiring

5.7.2.1 Frequency measurement inputs

Connect the signal to be measured at input B of the corresponding counter.

X1: DI byte 0

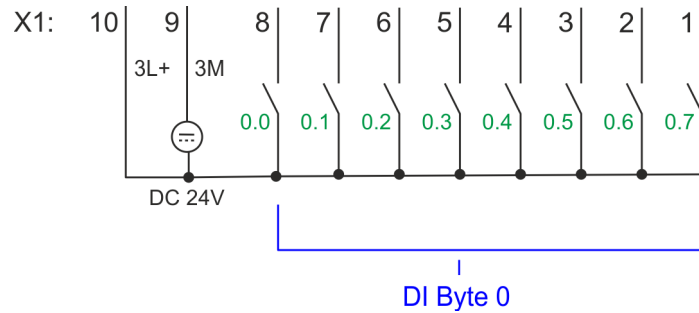

X1	Function	Type	LED	Description
			■ green	
1	DI 0.7	I	■	Frequency measurement 2 *
4	DI 0.4	I	■	Frequency measurement 1 *
7	DI 0.1	I	■	Frequency measurement 0 *
9	0 V	I		3M: GND for frequency measurement
10	DC 24V	I	■	3L+: DC 24V power section supply for frequency measurement

*) Max. input frequency 100kHz otherwise 1kHz.

X5: DI byte 1

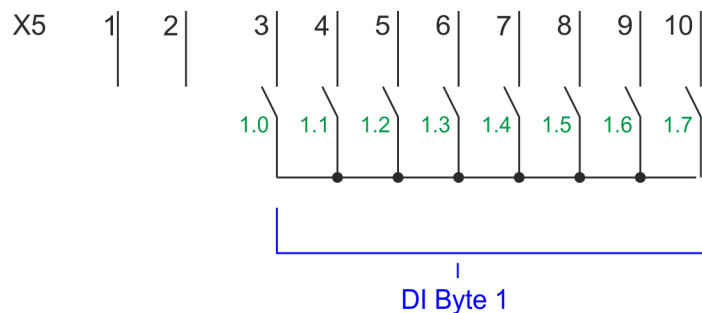

X5	Function	Type	LED	Description
			■ green	
5	DI 1.2	I	■	Frequency measurement 3 *

*) Max. input frequency 100kHz otherwise 1kHz.

5.7.3 Proceeding

Hardware configuration

In the Siemens SIMATIC Manager the following steps should be executed:

1. ➤ Perform a hardware configuration for the CPU. ↪ *Chap. 4.4 'Hardware configuration - CPU' page 68*
2. ➤ Double-click the counter sub module of the CPU 314C-2 PN/DP (314-6EH04-0AB0 V3.3).
⇒ The dialog '*Properties*' is opened.
3. ➤ As soon as you select the operating mode for the corresponding channel, a dialog box with default values for this counter mode is created and shown. Select for the corresponding channel the operating mode '*Frequency counting*'.
4. ➤ Perform the required parameter settings.
5. ➤ Save your project with '*Station → Safe and compile*'.
6. ➤ Transfer your project to your CPU.

User program

- The SFB 48 should cyclically be called (e.g. OB 1) for controlling the frequency measurement.
- The SFB is to be called with the corresponding instance DB. Here the parameters of the SFB are stored.

5.7.4 Parametrization

5.7.4.1 Address assignment

Sub module	Input address	Access	Description
Counter	816	DINT	Channel 0: Frequency value
	820	DINT	Channel 1: Frequency value
	824	DINT	Channel 2: Frequency value
	828	DINT	Channel 3: Frequency value

Sub module	Output address	Access	Description
Counter	816	DWORD	reserved
	820	DWORD	reserved
	824	DWORD	reserved
	828	DWORD	reserved

5.7.4.2 Interrupt selection

Via 'Basic parameters' you can reach 'Select interrupt'. Here you can define the interrupts the CPU will trigger. The following parameters are supported:

- None: The interrupt function is de-activated.
- Process: The following events of the frequency measurement can trigger a hardware interrupt (selectable via 'Frequency counting'):
 - End of measurement
- Diagnostics and process: A diagnostics interrupt is only triggered when a hardware interrupt was lost.

5.7.4.3 Frequency measurement

Parameter hardware configuration

Default values and structure of this dialog box depend on the selected 'Operating mode'. The following parameters are relevant for frequency measurement, which must be specified or determined:

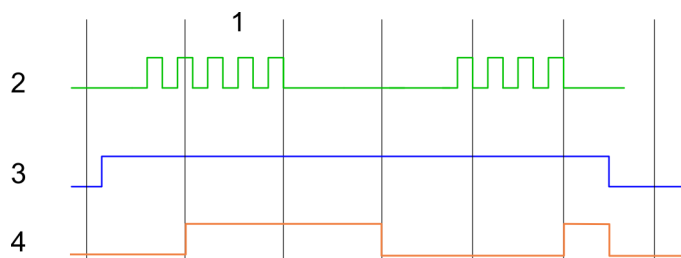











- 1 Integration time
- 2 Counting pulse
- 3 SW gate
- 4 Evaluated frequency









Parameter overview

Operating parameters	Description	Assignment	
Integration time	Specify the integration time Range of values: 10ms ... 10000ms in steps of 1ms	100ms	
max. counting frequency ...	Specify the max. frequency for the corresponding input	60kHz	
	Frequency		shortest permissible count pulse
	1kHz		400µs
	2kHz		200µs
	5kHz		80µs
	10kHz		40µs
	30kHz		13µs
	60kHz		6.7µs
Hardware interrupt	Description	Assignment	
End of measurement	Hardware interrupt at end of measurement	de-activated	

5.7.5 Status indication



X1	Function	Type	LED  green	Description
1	DI 0.7	I		Digital input DI 7 / Counter 2 (B) / Frequency 2 *
2	DI 0.6	I		Digital input DI 6 / Counter 2 (A) *
3	DI 0.5	I		Digital input DI 5
4	DI 0.4	I		Digital input DI 4 / Counter 1 (B) / Frequency 1 *
5	DI 0.3	I		Digital input DI 3 / Counter 1 (A) *
6	DI 0.2	I		Digital input DI 2
7	DI 0.1	I		Digital input DI 1 / Counter 0 (B) / Frequency 0 *
8	DI 0.0	I		Digital input DI 0 / Counter 0 (A) *
9	0 V	I		3M: GND for onboard DI power section supply
10	DC 24V	I		3L+: DC 24V for onboard DI power section supply

*) Max. input frequency 100kHz otherwise 1kHz.

X5	Function	Type	LED  green	Description
1	-	-		reserved
2	-	-		reserved
3	DI 1.0	I		Digital input DI 8
4	DI 1.1	I		Digital input DI 9 / Counter 3 (A) *
5	DI 1.2	I		Digital input DI 10 / Counter 3 (B) / Frequency 3 *
6	DI 1.3	I		Digital input DI 11 / Gate 3 *
7	DI 1.4	I		Digital input DI 12
8	DI 1.5	I		Digital input DI 13
9	DI 1.6	I		Digital input DI 14
10	DI 1.7	I		Digital input DI 15 / Latch 3 *

*) Max. input frequency 100kHz otherwise 1kHz.

DI +x

Digital input	LED  green	Description
DI +0.0 DI +0.7		Digital I+0.0 ... 0.7 has "1" signal
	<input type="checkbox"/>	Digital I+0.0 ... 0.7 has "0" signal
DI +1.0 ... DI +1.7		Digital input I+1.0 ... 1.7 has "1" signal
	<input type="checkbox"/>	Digital input I+1.0 ... 1.7 has "0" signal

xL+

Power supply	LED <input checked="" type="checkbox"/> green	Description
1L+	<input checked="" type="checkbox"/>	DC 24V electronic section supply
	<input type="checkbox"/>	DC 24V electronic section supply not available
3L+	<input checked="" type="checkbox"/>	DC 24V power section supply inputs OK
	<input type="checkbox"/>	DC 24V power section supply inputs not available
4L+	<input checked="" type="checkbox"/>	DC 24V power section supply outputs OK
	<input type="checkbox"/>	DC 24V power section supply outputs not available

xF

Error	LED <input checked="" type="checkbox"/> green / <input checked="" type="checkbox"/> red	Description
4M	<input checked="" type="checkbox"/>	Error, overload respectively short circuit on the outputs
	<input type="checkbox"/>	no error

5.8 Pulse width modulation - PWM

5.8.1 Properties

- By presetting of time parameters, the CPU evaluates a pulse sequence with according pulse/pause ratio and outputs it via the according output channel.
- Channel 0 and 1 are supported
- Control by the user program via SFB 49



More information about the usage of this block may be found in the manual "SPEED7 Operation List" from VIPA.

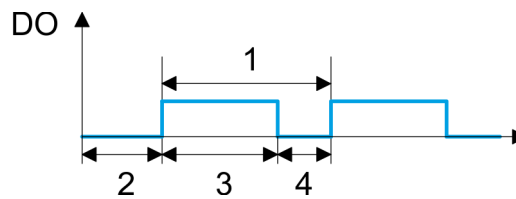

- 1 Period
- 2 On-delay
- 3 Pulse duration
- 4 Pulse pause







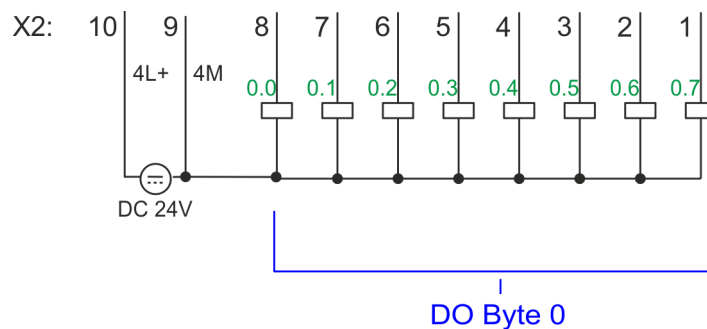

The counting function is disabled during the pulse width modulation on the same channel.

5.8.2 Wiring

5.8.2.1 Pulse width modulation outputs

X2: DO byte 0









X2	Function	Type	LED	Description
			 green  red	
7	DO 0.1	O		PWM 1
8	DO 0.0	O		PWM 0
9	0 V	I		4M: GND for PWM LED (red) is on at short circuit respectively overload
10	DC 24V	I		4L+: DC 24V power section supply for PWM

5.8.3 Proceeding

Hardware configuration

PWM and *pulse train* output use the same hardware configuration. Switching between these modes is done within the SFB 49. In the Siemens SIMATIC Manager the following steps should be executed:

1.  Perform a hardware configuration for the CPU. [↪ Chap. 4.4 'Hardware configuration - CPU' page 68](#)
2.  Double-click the counter sub module of the CPU 314C-2 PN/DP.
⇒ The dialog '*Properties*' is opened.
3.  As soon as you select the operating mode for the corresponding channel, a dialog box with default values for this counter mode is created and shown. For *PWM* respectively *pulse train* output select for the corresponding channel the operating mode '*Pulse width modulation - PWM*'.
4.  Perform the required parameter settings.
5.  Save your project with '*Station → Safe and compile*'.
6.  Transfer your project to your CPU.

User program

- The SFB 49 should cyclically be called (e.g. OB 1) for controlling the pulse width modulation.
 - The SFB 49 is used for *PWM* and *pulse train* output.
 - The switching between the modes takes place by the presetting of the *pulse number* (JOB_ID = 08h/09h). As soon as you specify a *pulse number* > 0, you switch to the *pulse train* mode, otherwise *PWM* is active.
- The SFB is to be called with the corresponding instance DB. Here the parameters of the SFB are stored.

5.8.4 Parametrization

5.8.4.1 Address assignment

Sub module	Input address	Access	Description
<i>Counter</i>	816	DINT	reserved
	820	DINT	reserved
	824	DINT	reserved
	828	DINT	reserved

Sub module	Output address	Access	Description
Counter	816	DWORD	reserved
	820	DWORD	reserved
	824	DWORD	reserved
	828	DWORD	reserved

5.8.4.2 Pulse width modulation

Parameter hardware configuration

Default values and structure of this dialog box depend on the selected 'Operating mode'. The following parameters are relevant for PWM, which must be specified or determined:

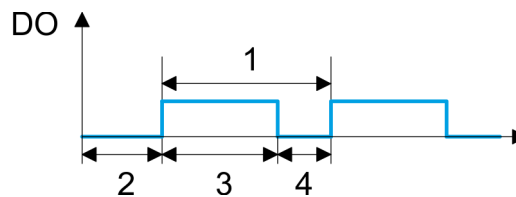

- 1 Period
- 2 On-delay
- 3 Pulse duration
- 4 Pulse pause



Parameter overview

Operating parameters	Description	Assignment
Output format	<p>Here specify the range of values for the output. The CPU hereby determines the pulse duration:</p> <ul style="list-style-type: none"> ■ Per mil <ul style="list-style-type: none"> – Output value is within 0 ... 1000 – Pulse duration = (Output value / 1000) x Period ■ S7 Analog value: <ul style="list-style-type: none"> – Output value is Siemens S7 analog value 0 ... 27648 – Pulse duration = (Output value / 27648) x Period 	Per mil
Time base	<p>Here you can set the time base, which will apply for resolution and range of values of the period duration, minimum pulse duration and on-delay.</p> <ul style="list-style-type: none"> ■ 1ms: Die Time base is 1ms ■ 0.1ms: Time base is 0.1ms 	0.1ms
On-delay	<p>Enter here a value for the time to expire from the start of the output sequence to the output of the pulse. The pulse sequence is output at the output channel, on expiration of the on-delay.</p> <p>Range of values: 0 ... 65535 from this there are the following effective values:</p> <ul style="list-style-type: none"> ■ Time base 1ms: 0 ... 65535ms ■ Time base 0.1ms: 0 ... 6553.5ms 	0

Operating parameters	Description	Assignment
Period	<p>With the period you define the length of the output sequence, which consists of pulse duration and pulse pause.</p> <p>Range of values:</p> <p>Time base 1ms: 1 ... 87ms</p> <p>Time base 0.1ms: 0.4 ... 87.0ms</p>	50*
Minimum pulse duration	<p>With the minimum pulse duration you can suppress short output pulses and short pulse pauses. All pulses or pauses, which are smaller than the minimum pulse duration, are suppressed. This allows you to filter very short pulses (spikes), which can not be recognized by the periphery.</p> <p>Range of values:</p> <p>Time base 1ms: 0 ... Period / 2 * 1ms</p> <p>Time base 0.1ms: 2 ... Period / 2 * 0.1ms</p>	2

*) This value can vary depending on the configuration tool and can be out of range. Values, which are out of range are invalid and must be adjusted accordingly!

5.8.5 Status indication

Digital output	LED	Description
	 green	
DO +0.0		PWM 0 has "1" signal
	<input type="checkbox"/>	PWM 0 has "0" signal
DO +0.1		PWM 1 has "1" signal
	<input type="checkbox"/>	PWM 1 has "0" signal

Pulse width modulation - PWM > Status indication

xL+

Power supply	LED <input checked="" type="checkbox"/> green	Description
1L+	<input checked="" type="checkbox"/>	DC 24V electronic section supply
	<input type="checkbox"/>	DC 24V electronic section supply not available
3L+	<input checked="" type="checkbox"/>	DC 24V power section supply inputs OK
	<input type="checkbox"/>	DC 24V power section supply inputs not available
4L+	<input checked="" type="checkbox"/>	DC 24V power section supply outputs OK
	<input type="checkbox"/>	DC 24V power section supply outputs not available

xF

Error	LED <input checked="" type="checkbox"/> green / <input checked="" type="checkbox"/> red	Description
4M	<input checked="" type="checkbox"/>	Error, overload respectively short circuit on the outputs
	<input type="checkbox"/>	no error

5.9 Pulse train

5.9.1 Properties

- By presetting of time parameters, the CPU evaluates a pulse sequence with according pulse/pause ratio and outputs it via the according output channel.
- The output is as a pulse-direction command (P/D).
 - Output frequency pattern via pulse train channel
 - To output the direction, an additional output is to be used, which is to be controlled via your user program.
- Channel 0 and 1 are supported
- Control by the user program via SFB 49



More information about the usage of this block may be found in the manual "SPEED7 Operation List" from VIP A.

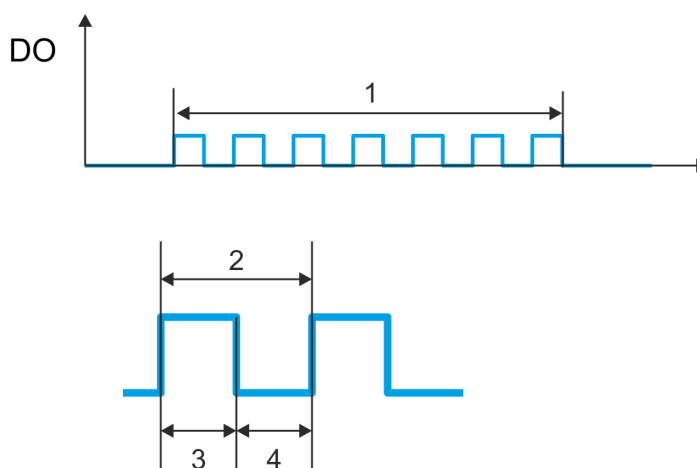

- 1 Number of pulses
- 2 Period duration
- 3 Pulse duration
- 4 Pulse pause



The counting function is disabled during the pulse train output on the same channel.

5.9.2 Wiring

5.9.2.1 Pulse train outputs

X2: DO byte 0

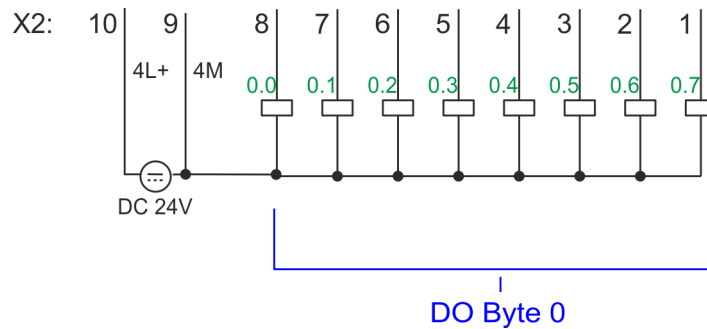

X2	Function	Type	LED ■ green ■ red	Description
7	DO 0.1	O	■	Pulse train 1
8	DO 0.0	O	■	Pulse train 0
9	0 V	I	■	4M: GND for pulse train LED (red) is on at short circuit respectively overload
10	DC 24V	I	■	4L+: DC 24V power section supply for pulse train

5.9.3 Proceeding

Hardware configuration

PWM and *pulse train* output use the same hardware configuration. Switching between these modes is done within SFB 49. In the Siemens SIMATIC Manager the following steps should be executed:

1. ➤ Perform a hardware configuration for the CPU. ↪ *Chap. 4.4 'Hardware configuration - CPU' page 68*
2. ➤ Double-click the counter sub module of the CPU 314C-2 PN/DP.
 ⇒ The dialog '*Properties*' is opened.
3. ➤ As soon as you select the operating mode for the corresponding channel, a dialog box with default values for this counter mode is created and shown. For *PWM* respectively *pulse train* output select for the corresponding channel the operating mode '*Pulse width modulation - PWM*'.
4. ➤ Perform the required parameter settings.
5. ➤ Save your project with '*Station → Safe and compile*'.
6. ➤ Transfer your project to your CPU.

User program

- The SFB 49 should cyclically be called (e.g. OB 1) for controlling the pulse train output.
 - The SFB 49 is used for *PWM* and *pulse train* output.
 - The switching between the modes takes place by the presetting of the *pulse number* (JOB_ID = 08h/09h). As soon as you specify a *pulse number* > 0, you switch to the *pulse train* mode, otherwise *PWM* is active.
- The SFB is to be called with the corresponding instance DB. Here the parameters of the SFB are stored.

5.9.4 Parametrization**5.9.4.1 Address assignment**

Sub module	Input address	Access	Description
Counter	816	DINT	reserved
	820	DINT	reserved
	824	DINT	reserved
	828	DINT	reserved

Sub module	Output address	Access	Description
Counter	816	DWORD	reserved
	820	DWORD	reserved
	824	DWORD	reserved
	828	DWORD	reserved

5.9.4.2 Pulse train output**Parameter hardware configuration**

Default values and structure of this dialog box depend on the selected 'Operating mode'. For *pulse train* following parameters are relevant, to be specified or determined:

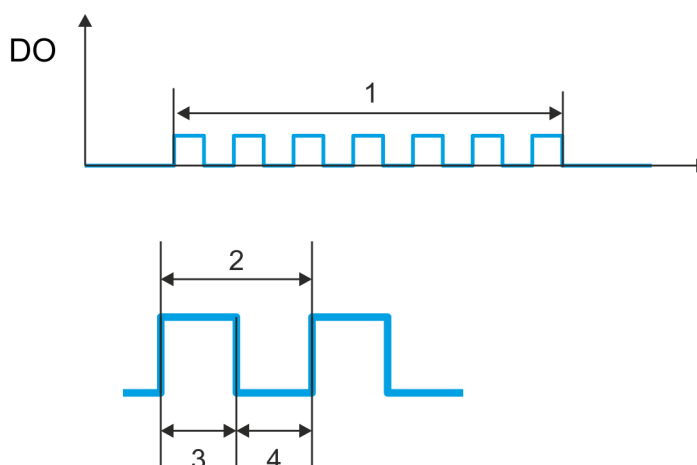

- 1 Number of pulses
- 2 Period duration
- 3 Pulse duration
- 4 Pulse pause

Parameter overview

Operating parameters	Description	Assignment
Output format	<p>Here specify the range of values for the output. The CPU hereby determines the pulse duration:</p> <ul style="list-style-type: none"> ■ Per mil <ul style="list-style-type: none"> – Output value is within 0 ... 1000 – Pulse duration = (Output value / 1000) x period duration ■ S7 Analog value: <ul style="list-style-type: none"> – Output value is Siemens S7 analog value 0 ... 27648 – Pulse duration = (Output value / 27648) x period duration 	Per mil
Time base	<p>Here you can set the time base, which will apply for resolution and range of values of the period duration, minimum pulse duration and on-delay.</p> <ul style="list-style-type: none"> ■ 1ms: The time base is 1ms ■ 0.1ms: Time base is 0.1ms 	0.1ms
On-delay	This parameter is ignored.	0
Period duration	<p>With <i>period duration</i> you define the length of the output sequence, which consists of pulse duration and pulse pause.</p> <p>Range of values:</p> <p>Time base 1ms: 1 ... 87ms</p> <p>Time base 0.1ms: 0.4 ... 87.0ms</p>	50*
Minimum pulse duration	<p>With the <i>minimum pulse duration</i> you can suppress short output pulses and short pulse pauses. All pulses or pauses, which are smaller than the <i>minimum pulse duration</i>, are suppressed. This allows you to filter very short pulses (spikes), which can not be recognized by the periphery.</p> <p>Range of values:</p> <p>Time base 1ms: 0 ... Period duration / 2 * 1ms</p> <p>Time base 0.1ms: 2 ... Period duration / 2 * 0.1ms</p>	2

*) This value can vary depending on the configuration tool and can be out of range. Values, which are out of range are invalid and must be adjusted accordingly!

5.9.5 Status indication

Digital output	LED	Description
DO +0.0	<input checked="" type="checkbox"/> green	Pulse train 0 has "1" signal
	<input type="checkbox"/>	Pulse train 0 has "0" signal
DO +0.1	<input checked="" type="checkbox"/>	Pulse train 1 has "1" signal
	<input type="checkbox"/>	Pulse train 1 has "0" signal

xL+

Power supply	LED ■ green	Description
1L+	■	DC 24V electronic section supply
	□	DC 24V electronic section supply not available
3L+	■	DC 24V power section supply inputs OK
	□	DC 24V power section supply inputs not available
4L+	■	DC 24V power section supply outputs OK
	□	DC 24V power section supply outputs not available

xF

Error	LED ■ green / ■ red	Description
4M	■	Error, overload respectively short circuit on the outputs
	□	no error

5.10 Diagnostic and interrupt

5.10.1 Overview

Hardware interrupt

The parametrization allows you to define the following trigger for a hardware interrupt:

- Edge at an digital interrupt input
- Reaching the comparison value
- Overflow respectively at overrun upper counter limit
- Underflow respectively at underrun lower counter limit
- Opening the HW gate with open SW gate - except for counter 3
- Closing the HW gate with open SW gate - except for counter 3

Diagnostics interrupt

The VIPA specific parameters allow you to define the following trigger for a diagnostics interrupt ↪ *Chap. 4.8 'Setting VIPA specific CPU parameters' page 80:*

- Hardware interrupt lost
- Error: 4L+ DC 24V DO power section supply
- Error: 3L+: DC 24V DI power section supply
- Short circuit overload: DO

5.10.2 Process interrupt



An interrupt for the corresponding channel operating mode can only be triggered if you have additionally parameterized 'Diagnostics+Process' at 'Select interrupt' of the 'Basic parameters'.

A process interrupt causes a call of the OB 40. Within the OB 40 you may find the logical basic address of the module that initialized the process interrupt by using the Local word 6. More detailed information about the initializing event is to find in the *local double word 8*. The assignment of *local double word 8* depends on the parameterized operating mode of each channel.

Local double word 8 of OB 40 at Alarm Inputs

Local byte	Bit 7...0
8	<ul style="list-style-type: none"> ■ Bit 0: Edge at I+0.0 ■ Bit 1: Edge at I+0.1 ■ Bit 2: Edge at I+0.2 ■ Bit 3: Edge at I+0.3 ■ Bit 4: Edge at I+0.4 ■ Bit 5: Edge at I+0.5 ■ Bit 6: Edge at I+0.6 ■ Bit 7: Edge at I+0.7
9	<ul style="list-style-type: none"> ■ Bit 0: Edge at I+1.0 ■ Bit 1: Edge at I+1.1 ■ Bit 2: Edge at I+1.2 ■ Bit 3: Edge at I+1.3 ■ Bit 4: Edge at I+1.4 ■ Bit 5: Edge at I+1.5 ■ Bit 6: Edge at I+1.6 ■ Bit 7: Edge at I+1.7
10...11	<ul style="list-style-type: none"> ■ Bit 7 ... 0: reserved

Local double word 8 of OB 40 at counter function

Local byte	Bit 7...0
8	<ul style="list-style-type: none"> ■ Bit 1, 0: 0 (fix) ■ Bit 2: Over-/underflow value counter 0 ■ Bit 3: Counter 0 reached comparison value ■ Bit 7 ... 4: 0 (fix)
9	<ul style="list-style-type: none"> ■ Bit 1, 0: 0 (fix) ■ Bit 2: Over-/underflow value counter 1 ■ Bit 3: Counter 1 reached comparison value ■ Bit 7 ... 4: 0 (fix)
10	<ul style="list-style-type: none"> ■ Bit 1, 0: 0 (fix) ■ Bit 2: Over-/underflow value counter 2 ■ Bit 3: Counter 2 reached comparison value ■ Bit 7 ... 4: 0 (fix)
11	<ul style="list-style-type: none"> ■ Bit 0: Gate counter 3 open (activated) ■ Bit 1: Gate counter 3 closed ■ Bit 2: Over-/underflow value counter 3 ■ Bit 3: Counter 3 reached comparison value ■ Bit 4: Counter 3 new latch value ■ Bit 7 ... 5: 0 (fix)

Local double word 8 of OB 40 at *frequency measurement*

Local byte	Bit 7...0
8	<ul style="list-style-type: none"> ■ Bit 0: End of measurement channel 0 (end of the integration time) ■ Bit 7 ... 1: 0 (fix)
9	<ul style="list-style-type: none"> ■ Bit 0: End of measurement channel 1 (end of the integration time) ■ Bit 7 ... 1: 0 (fix)
10	<ul style="list-style-type: none"> ■ Bit 0: End of measurement channel 2 (end of the integration time) ■ Bit 7 ... 1: 0 (fix)
11	<ul style="list-style-type: none"> ■ Bit 0: End of measurement channel 3 (end of the integration time) ■ Bit 7 ... 1: 0 (fix)

5.10.3 Diagnostic interrupt**Function**

An interrupt for the corresponding channel operating mode can only be triggered if you have additionally parameterized 'Diagnostics+Process' at 'Select interrupt' of the 'Basic parameters'.

Via the parameterization (record set 7Fh) you may activate a global diagnostic interrupt for the module. A diagnostic interrupt occurs when during a process interrupt execution in OB 40 another process interrupt is thrown for the same event. The initialization of a diagnostic interrupt interrupts the recent process interrupt execution in OB 40 and branches in OB 82 to diagnostic interrupt processing_{incoming}. If during the diagnostic interrupt processing other events are occurring at other channels that may also cause a process res. diagnostic interrupt, these are interim stored. After the end of the diagnostic interrupt processing at first all interim stored diagnostic interrupts are processed in the sequence of their occurrence and then all process interrupts. If a channel where currently a diagnostic interrupt_{incoming} is processed res. interim stored initializes further process interrupts, these get lost. When a process interrupt for which a diagnostic interrupt_{incoming} has been released is ready, the diagnostic interrupt processing is called again as diagnostic interrupt_{outgoing}. All events of a channel between diagnostic interrupt_{incoming} and diagnostic interrupt_{outgoing} are not stored and get lost. Within this time window (1. diagnostic interrupt_{incoming} until last diagnostic interrupt_{outgoing}) the SF-LED of the CPU is on. Additionally for every diagnostic interrupt_{incoming/outgoing} an entry in the diagnostic buffer of the CPU occurs.

Example:

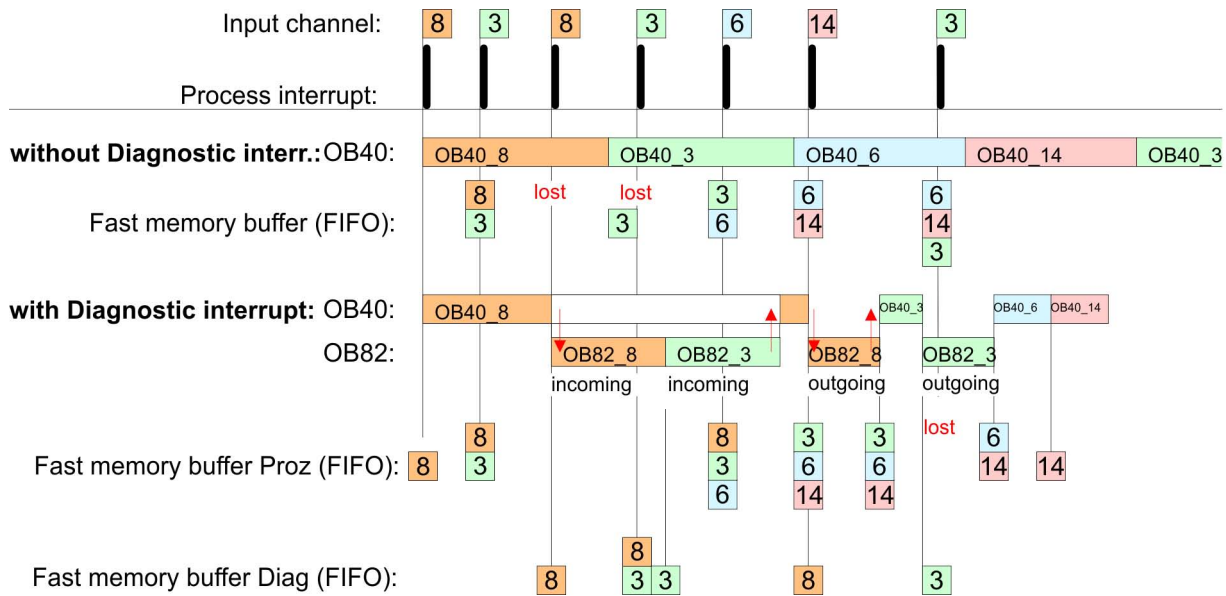

Diagnostic interrupt processing

Every OB 82 call causes an entry in the diagnostic buffer of the CPU containing error cause and module address. By using the SFC 59 you may read the diagnostic bytes. At de-activated diagnostic interrupt you have access to the last recent diagnostic event. If you've activated the diagnostic function in your hardware configuration, the contents of record set 0 are already in the local double word 8 when calling the OB 82. The SFC 59 allows you to also read the record set 1 that contains additional information. After leaving the OB 82 a clear assignment of the data to the last diagnostic interrupt is not longer possible. The record sets of the diagnostic range have the following structure:

Record set 0 Diagnostic_{incoming}

Byte	Bit 7...0
0	<ul style="list-style-type: none"> Bit 0: set at module failure <ul style="list-style-type: none"> Counter/Frequency measurement: Process interrupt lost Digital input: Process interrupt lost Missing power supply DI or DO Digital output: short circuit/overload Bit 1: set at internal error <ul style="list-style-type: none"> Missing power supply DI or DO Digital output: short circuit/overload Bit 2: set at external error Bit 3: set at channel error Bit 4: set at missing external power supply Bit 7 ... 5: 0 (fix)
1	<ul style="list-style-type: none"> Bit 3 ... 0: Module class <ul style="list-style-type: none"> 1111b: Digital module or 1000b: Function module Bit 4: Channel information present <ul style="list-style-type: none"> Counter/Frequency measurement: Process interrupt lost Digital input: Process interrupt lost Missing power supply DI or DO Digital output: short circuit/overload Bit 7 ... 5: 0 (fix)

Byte	Bit 7...0
2	<ul style="list-style-type: none"> ■ Bit 3 ... 0: 0 (fix) ■ Bit 4: set at missing internal power supply <ul style="list-style-type: none"> – Missing power supply DI or DO ■ Bit 7 ... 5: 0 (fix)
3	<ul style="list-style-type: none"> ■ Bit 5 ... 0: 0 (fix) ■ Bit 6: Process interrupt lost ■ Bit 7: 0 (fix)

Record set 0 Diagnostic_{out-}going

After the removing error a diagnostic message_{outgoing} takes place if the diagnostic interrupt release is still active.

Byte	Bit 7...0
0	<ul style="list-style-type: none"> ■ Bit 0: set at module failure <ul style="list-style-type: none"> – Counter/Frequency measurement: Process interrupt lost – Digital input: Process interrupt lost – Missing power supply DI or DO – Digital output: short circuit/overload ■ Bit 1: set at internal error <ul style="list-style-type: none"> – Missing power supply DI or DO – Digital output: short circuit/overload ■ Bit 2: set at external error ■ Bit 3: set at channel error ■ Bit 4: set at missing external power supply ■ Bit 7 ... 5: 0 (fix)
1	<ul style="list-style-type: none"> ■ Bit 3 ... 0: Module class <ul style="list-style-type: none"> – 1111b: Digital module or – 1000b: Function module ■ Bit 4: Channel information present <ul style="list-style-type: none"> – Counter/Frequency measurement: Process interrupt lost – Digital input: Process interrupt lost – Missing power supply DI or DO – Digital output: short circuit/overload ■ Bit 7 ... 5: 0 (fix)
2	<ul style="list-style-type: none"> ■ Bit 3 ... 0: 0 (fix) ■ Bit 4: set at missing internal power supply <ul style="list-style-type: none"> – Missing power supply DI or DO ■ Bit 7 ... 5: 0 (fix)
3	<ul style="list-style-type: none"> ■ Bit 7 ... 0: 0 (fix)



The record set 0 of the alarm interrupts, counter function, frequency measurement and pulse width modulation has the same structure. There are differences in the structure of record set 1.

Diagnostic record set 1 at Alarm Inputs

The record set 1 contains the 4byte of the record set 0 and additionally 12byte module specific diagnostic data. The diagnostic bytes have the following assignment:

Byte	Bit 7...0
0 ... 3	Content record set 0 ↗ 'Record set 0 Diagnostic _{incoming} ' page 158
4	<ul style="list-style-type: none"> ■ Bit 6 ... 0: Channel type (here 70h) <ul style="list-style-type: none"> – 70h: Digital input ■ Bit 7: More channel types present <ul style="list-style-type: none"> – 0: no – 1: yes
5	Number of diagnostic bits per channel (here 08h)
6	Number of channels of a module (here 08h)
7	<ul style="list-style-type: none"> ■ Bit 0: Error in channel group 0 (I+0.0 ... I+0.3) ■ Bit 1: Error in channel group 1 (I+0.4 ... I+0.7) ■ Bit 2: Error in channel group 2 (I+1.0 ... I+1.3) ■ Bit 3: Error in channel group 2 (I+1.4 ... I+1.7) ■ Bit 7 ... 4: reserved
8	Diagnostic interrupt due to "process interrupt lost" at... <ul style="list-style-type: none"> ■ Bit 0: ... input I+0.0 ■ Bit 1: 0 (fix) ■ Bit 2: ... input I+0.1 ■ Bit 3: 0 (fix) ■ Bit 4: ... input I+0.2 ■ Bit 5: 0 (fix) ■ Bit 6: ... input I+0.3 ■ Bit 7: 0 (fix)
9	Diagnostic interrupt due to "process interrupt lost" at... <ul style="list-style-type: none"> ■ Bit 0: ... input I+0.4 ■ Bit 1: 0 (fix) ■ Bit 2: ... input I+0.5 ■ Bit 3: 0 (fix) ■ Bit 4: ... input I+0.6 ■ Bit 5: 0 (fix) ■ Bit 6: ... input I+0.7 ■ Bit 7: 0 (fix)
10	Diagnostic interrupt due to "process interrupt lost" at... <ul style="list-style-type: none"> ■ Bit 0: ... input I+1.0 ■ Bit 1: 0 (fix) ■ Bit 2: ... input I+1.1 ■ Bit 3: 0 (fix) ■ Bit 4: ... input I+1.2 ■ Bit 5: 0 (fix) ■ Bit 6: ... input I+1.3 ■ Bit 7: 0 (fix)

Byte	Bit 7...0
11	Diagnostic interrupt due to "process interrupt lost" at... <ul style="list-style-type: none"> ■ Bit 0: ... input I+1.4 ■ Bit 1: 0 (fix) ■ Bit 2: ... input I+1.5 ■ Bit 3: 0 (fix) ■ Bit 4: ... input I+1.6 ■ Bit 5: 0 (fix) ■ Bit 6: ... input I+1.7 ■ Bit 7: 0 (fix)
12 ... 15	■ Bit 7 ... 0: reserved

Diagnostic record set 1 at counter function

The record set 1 contains the 4byte of the record set 0 and additionally 12byte module specific diagnostic data. The diagnostic bytes have the following assignment:

Byte	Bit 7...0
0 ... 3	Content record set 0 ↪ 'Record set 0 Diagnostic _{incoming} ' page 158
4	<ul style="list-style-type: none"> ■ Bit 6 ... 0: Channel type (here 76h) <ul style="list-style-type: none"> – 76h: Function module ■ Bit 7: More channel types present <ul style="list-style-type: none"> – 0: no – 1: yes
5	Number of diagnostic bits per channel (here 08h)
6	Number of channels of a module (here 04h)
7	<ul style="list-style-type: none"> ■ Bit 0: Error in channel group 0 (Counter 0) ■ Bit 1: Error in channel group 1 (Counter 1) ■ Bit 2: Error in channel group 2 (Counter 2) ■ Bit 3: Error in channel group 3 (Counter 3) ■ Bit 7 ... 4: reserved
8	Diagnostic interrupt due to "process interrupt lost" at... <ul style="list-style-type: none"> ■ Bit 1, 0: reserved ■ Bit 2: Over-/underflow/end value counter 0 ■ Bit 3: Counter 0 reached comparison value ■ Bit 7 ... 4: 0 (fix)
9	Diagnostic interrupt due to "process interrupt lost" at... <ul style="list-style-type: none"> ■ Bit 1, 0: reserved ■ Bit 2: Over-/underflow/end value counter 1 ■ Bit 3: Counter 1 reached comparison value ■ Bit 7 ... 4: 0 (fix)
10	Diagnostic interrupt due to "process interrupt lost" at... <ul style="list-style-type: none"> ■ Bit 1, 0: reserved ■ Bit 2: Over-/underflow/end value counter 2 ■ Bit 3: Counter 2 reached comparison value ■ Bit 7 ... 4: 0 (fix)

Byte	Bit 7...0
11	Diagnostic interrupt due to "process interrupt lost" at... <ul style="list-style-type: none"> ■ Bit 0: Gate counter 3 open (activated) ■ Bit 1: Gate counter 3 closed ■ Bit 2: Over-/underflow/end value counter 3 ■ Bit 3: Counter 3 reached comparison value ■ Bit 4: Counter 3 new latch value ■ Bit 7 ... 5: 0 (fix)
12 ...15	■ Bit 7 ... 0: reserved

Diagnostic Record set 1 at frequency measurement

The record set 1 contains the 4byte of the record set 0 and additionally 12byte module specific diagnostic data. The diagnostic bytes have the following assignment:

Byte	Bit 7...0
0 ... 3	Content record set 0 ↪ 'Record set 0 Diagnostic _{incoming} ' page 158
4	<ul style="list-style-type: none"> ■ Bit 6 ... 0: Channel type (here 76h) <ul style="list-style-type: none"> – 76h: Function module ■ Bit 7: More channel types present <ul style="list-style-type: none"> – 0: no – 1: yes
5	Number of diagnostic bits per channel (here 08h)
6	Number of channels of a module (here 04h)
7	<ul style="list-style-type: none"> ■ Bit 0: Error in channel group 4 (Frequency meter 0) ■ Bit 1: Error in channel group 5 (Frequency meter 1) ■ Bit 2: Error in channel group 6 (Frequency meter 2) ■ Bit 3: Error in channel group 7 (Frequency meter 3) ■ Bit 7 ... 4: 0 (fix)
8	Diagnostic interrupt due to "process interrupt lost" at... <ul style="list-style-type: none"> ■ Bit 0: End of measurement channel 0 (End of integration time) ■ Bit 7 ... 1: 0 (fix)
9	Diagnostic interrupt due to "process interrupt lost" at... <ul style="list-style-type: none"> ■ Bit 0: End of measurement channel 1 (End of integration time) ■ Bit 7 ... 1: 0 (fix)
10	Diagnostic interrupt due to "process interrupt lost" at... <ul style="list-style-type: none"> ■ Bit 0: End of measurement channel 2 (End of integration time) ■ Bit 7 ... 1: 0 (fix)
11	Diagnostic interrupt due to "process interrupt lost" at... <ul style="list-style-type: none"> ■ Bit 0: End of measurement channel 3 (End of integration time) ■ Bit 7 ... 1: 0 (fix)
12 ... 15	0 (fix)

6 Deployment PG/OP communication - productive

6.1 Basics - Industrial Ethernet in automation

Overview

The flow of information in a company presents a vast spectrum of requirements that must be met by the communication systems. Depending on the area of business the bus system or LAN must support a different number of users, different volumes of data must be transferred and the intervals between transfers may vary, etc. It is for this reason that different bus systems are employed depending on the respective task. These may be subdivided into different classes. The following model depicts the relationship between the different bus systems and the hierarchical structures of a company:

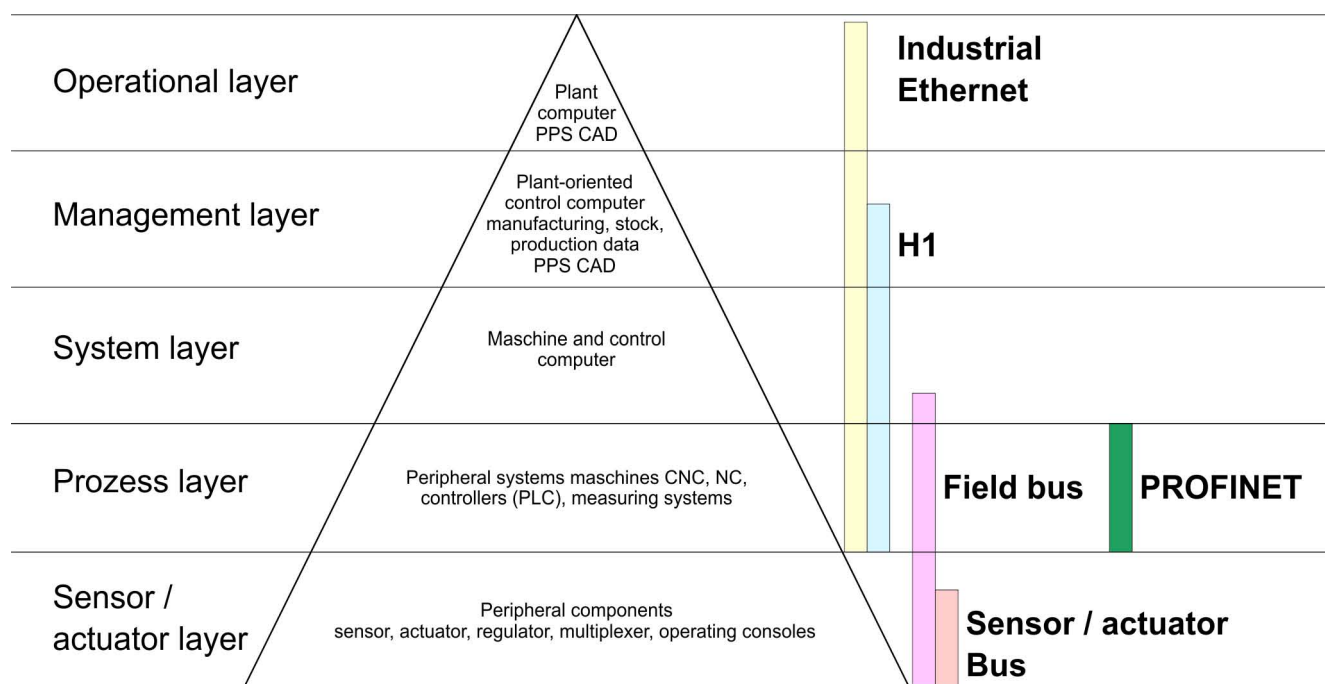

Industrial Ethernet

Industrial Ethernet is an electrical net based on shielded twisted pair cabling or optical net based on optical fibre. Industrial Ethernet is defined by the international standard IEEE 802.3

The net access of Industrial Ethernet corresponds to IEEE 802.3 - CSMA/CD (**C**arrier **S**ense **M**ultiple **A**ccess/**C**ollision **D**etection) scheme:

- Every station "listens" on the bus cable and receives communication messages that are addressed to it.
- Stations will only initiate a transmission when the line is unoccupied.
- In the event that two participants should start transmitting simultaneously, they will detect this and stop transmitting to restart after a random delay time has expired.
- Using switches there is the possibility for communication without collisions.

6.2 Basics - ISO/OSI reference model

Overview

The ISO/OSI reference model is based on a proposal that was developed by the International Standards Organization (ISO). This represents the first step towards an international standard for the different protocols. It is referred to as the ISO-OSI layer model. OSI is the abbreviation for **O**pen **S**ystem **I**nterconnection, the communication between open systems. The ISO/OSI reference model does not represent a network architecture as it does not define the services and protocols used by the different layers. The model simply specifies the tasks that the different layers must perform. All current communication systems are based on the ISO/OSI reference model, which is defined by the ISO 7498 standard. The reference model structures communication systems into 7 layers that cover different communication tasks. In this manner the complexity of the communication between different systems is divided amongst different layers to simplify the task.

The following layers have been defined:

- Layer 7 - Application Layer
- Layer 6 - Presentation Layer
- Layer 5 - Session Layer
- Layer 4 - Transport Layer
- Layer 3 - Network Layer
- Layer 2 - Data Link Layer
- Layer 1- Physical Layer

Depending on the complexity and the requirements of the communication mechanisms a communication system may use a subset of these layers.

Layer 1 - Bit communication layer (physical layer)

The bit communication layer (physical layer) is concerned with the transfer of data bits via the communication channel. This layer is therefore responsible for the mechanical, electrical and the procedural interfaces and the physical communication medium located below the bit communication layer:

- Which voltage represents a logical 0 or a 1?
- The minimum time the voltage is present to be recognized as a bit.
- The pin assignment of the respective interface.

Layer 2 - Security layer (data link layer)

This layer performs error-checking functions for bit strings transferred between two communicating partners. This includes the recognition and correction or flagging of communication errors and flow control functions. The security layer (data link layer) converts raw communication data into a sequence of frames. This is where frame limits are inserted on the transmitting side and where the receiving side detects them. These limits consist of special bit patterns that are inserted at the beginning and at the end of every frame. The security layer often also incorporates flow control and error detection functions. The data security layer is divided into two sub-levels, the LLC and the MAC level. The MAC (**M**edia **A**ccess **C**ontrol) is the lower level and controls how senders are sharing a single transmit channel. The LLC (**L**ogical **L**ink **C**ontrol) is the upper level that establishes the connection for transferring the data frames from one device into the other.

Layer 3 - Network layer

The network layer is an agency layer. Business of this layer is to control the exchange of binary data between stations that are not directly connected. It is responsible for the logical connections of layer 2 communications. Layer 3 supports the identification of the single network addresses and the establishing and disconnecting of logical communication channels. Additionally, layer 3 manages the prior transfer of data and the error processing of data packets. IP (Internet Protocol) is based on Layer 3.

Layer 4 - Transport layer

Layer 4 connects the network structures with the structures of the higher levels by dividing the messages of higher layers into segments and passes them on to the network layer. Hereby, the transport layer converts the transport addresses into network addresses. Common transport protocols are: TCP, SPX, NWLink and NetBEUI.

Layer 5 - Session layer	The session layer is also called the communication control layer. It relieves the communication between service deliverer and the requestor by establishing and holding the connection if the transport system has a short time fail out. At this layer, logical users may communicate via several connections at the same time. If the transport system fails, a new connection is established if needed. Additionally this layer provides methods for control and synchronization tasks.
Layer 6 - Presentation layer	This layer manages the presentation of the messages, when different network systems are using different representations of data. Layer 6 converts the data into a format that is acceptable for both communication partners. Here compression/decompression and encrypting/decrypting tasks are processed. This layer is also called interpreter. A typical use of this layer is the terminal emulation.
Layer 7 - Application layer	The application layer is the link between the user application and the network. The tasks of the application layer include the network services like file, print, message, data base and application services as well as the according rules. This layer is composed from a series of protocols that are permanently expanded following the increasing needs of the user.

6.3 Basics - Terms

Network (LAN)

A network res. LAN (Local Area Network) provides a link between different stations that enables them to communicate with each other. Network stations consist of PCs, IPCs, TCP/IP adapters, etc. Network stations are separated by a minimum distance and connected by means of a network cable. The combination of network stations and the network cable represent a complete segment. All the segments of a network form the Ethernet (physics of a network).

Twisted Pair

In the early days of networking the Triaxial- (yellow cable) or thin Ethernet cable (Cheapernet) was used as communication medium. This has been superseded by the twisted-pair network cable due to its immunity to interference. The CPU has a twisted-pair connector. The twisted-pair cable consists of 8 cores that are twisted together in pairs. Due to these twists this system provides an increased level of immunity to electrical interference. For linking please use twisted pair cable which at least corresponds to the category 5. Where the coaxial Ethernet networks are based on a bus topology the twisted-pair network is based on a point-to-point scheme. The network that may be established by means of this cable has a star topology. Every station is connected to the star coupler (hub/switch) by means of a separate cable. The hub/switch provides the interface to the Ethernet.

Hub (repeater)

The hub is the central element that is required to implement a twisted-pair Ethernet network. It is the job of the hub to regenerate and to amplify the signals in both directions. At the same time it must have the facility to detect and process segment wide collisions and to relay this information. The hub is not accessible by means of a separate network address since it is not visible to the stations on the network. A hub has provisions to interface to Ethernet or to another hub res. switch.

Switch

A switch also is a central element for realizing Ethernet on Twisted Pair. Several stations res. hubs are connected via a switch. Afterwards they are able to communicate with each other via the switch without interfering the network. An intelligent hardware analyses the incoming telegrams of every port of the switch and passes them collision free on to the destination stations of the switch. A switch optimizes the bandwidth in every connected segment of a network. Switches enable exclusive connections between the segments of a network changing at request.

6.4 Basics - Protocols

Overview

Protocols define a set of instructions or standards that enable computer to establish communication connections and exchange information as error free as possible. A commonly established protocol for the standardization of the complete computer communication is the so called ISO/OSI layer model, a model based upon seven layers with rules for the usage of hardware and software ↪ *Chap. 6.2 'Basics - ISO/OSI reference model' page 164*

The following protocols are used:

- Siemens S7 connections
- Open communication
 - TCP native according to RFC 793
 - ISO on TCP according to RFC 1006
 - UDP according to RFC 768

Siemens S7 connections

With the Siemens S7 connection large data sets may be transferred between PLC systems based on Siemens STEP®7. Here the stations are connected via Ethernet. Precondition for the Siemens S7 communication is a configured connection table, which contains the defined connections for communication. Here NetPro from Siemens may be used.

Properties:

- A communication connection is specified by a connection ID for each connection partner.
- The acknowledgement of the data transfer is established from the partner station at level 7 of the ISO/OSI reference model.
- At the PLC side FB/SFB VIPA handling blocks are necessary for data transfer for the Siemens S7 connections.



More information about the usage of these blocks may be found in the manual "SPEED7 Operation List" from VIPA.

Open communication

In the *'open communication'* the communication takes place via the user program by means of handling blocks. These blocks are also part of the Siemens SIMATIC Manager. You will find these in the *'Standard Library'* at *'Communication Blocks'*.

- *Connection-oriented protocols:*

Connection-oriented protocols establish a (logical) connection to the communication partner before data transmission is started. And if necessary they terminate the connection after the data transfer was finished. Connection-oriented protocols are used for data transmission when reliable, guaranteed delivery is of particular importance. In general, many logical connections can exist on one physical line. The following connection-oriented protocols are supported with FBs for open communication via Industrial Ethernet:

- *TCP native accord. to RFC 793:*

During data transmission, no information about the length or about the start and end of a message is transmitted. However, the receiver has no means of detecting where one message ends in the data stream and the next one begins. The transfer is stream-oriented. For this reason, it is recommended that the data length of the FBs is identical for the sending and receiving station. If the number of received data does not fit to the preset length you either will get not the whole data, or you will get data of the following job.

- *ISO on TCP accord. to RFC 1006:*

During data transmission, information on the length and the end of the message is also transmitted. If you have specified the length of the data to be received greater than the length of the data to be sent, the receive block will copy the received data completely into the receive range.

- *Connection-less protocol:*

There is thus no establishment and termination of a connection with a remote partner. Connection-less protocols transmit data with no acknowledge and with no reliable guaranteed delivery to the remote partner.

- *UDP accord. to RFC 768:*

In this case, when calling the sending block you have to specify the address parameters of the receiver (IP address and port number). During data transmission, information on the length and the end of the message is also transmitted. In order to be able to use the sending and receiving blocks first you have to configure the local communications access point at both sides. With each new call of the sending block, you re-reference the remote partner by specifying its IP address and its port number.

6.5 Basics - IP address and subnet**IP address structure**

Exclusively IPv4 is supported. At IPv4 the IP address is a 32bit address that must be unique within the network and consists of 4 numbers that are separated by a dot. Every IP address is a combination of a *Net-ID* and a *Host-ID* and has the following

Structure: **xxx.xxx.xxx.xxx**

Range: 000.000.000.000 to 255.255.255.255

Net-ID, Host-ID

The **Network-ID** identifies a network res. a network controller that administrates the network. The **Host-ID** marks the network connections of a participant (host) to this network.

Subnet mask

The **Host-ID** can be further divided into a *Subnet-ID* and a new *Host-ID* by using a bit for bit AND assignment with the Subnet mask.

The area of the original **Host-ID** that is overwritten by 1 of the Subnet mask becomes the **Subnet-ID**, the rest is the new **Host-ID**.

Subnet mask	binary all "1"	binary all "0"	
IPv4 address	Net-ID	Host-ID	
Subnet mask and IPv4 address	Net-ID	Subnet-ID	new Host-ID

Address at first start-up

At the first start-up of the CPU, the Ethernet PG/OP channel does not have an IP address.

Information about the assignment of IP address data to the Ethernet PG/OP channel may be found in [Chap. 4.6 'Hardware configuration - Ethernet PG/OP channel' page 71](#).

Address classes

For IPv4 addresses there are five address formats (class A to class E) that are all of a length of 4byte = 32bit.

Class A	0	Network-ID (1+7bit)	Host-ID (24bit)
Class B	10	Network-ID (2+14bit)	Host-ID (16bit)
Class C	110	Network-ID (3+21bit)	Host-ID (8bit)
Class D	1110	Multicast group	
Class E	11110	Reserved	

The classes A, B and C are used for individual addresses, class D for multicast addresses and class E is reserved for special purposes. The address formats of the 3 classes A, B, C are only differing in the length of Network-ID and Host-ID.

Private IP networks

These addresses can be used as net-ID by several organizations without causing conflicts, for these IP addresses are neither assigned in the Internet nor are routed in the Internet. To build up private IP-Networks within the Internet, RFC1597/1918 reserves the following address areas:

Network class	from IP	to IP	Standard subnet mask
A	10. <u>0.0.0</u>	10. <u>255.255.255</u>	255. <u>0.0.0</u>
B	172.16. <u>0.0</u>	172.31. <u>255.255</u>	255.255. <u>0.0</u>
C	192.168. <u>0.0</u>	192.168. <u>255.255</u>	255.255.255. <u>0</u>

(The Host-ID is underlined.)

Reserved Host-IDs

Some Host-IDs are reserved for special purposes.

Host-ID = "0"	Identifier of this network, reserved!
Host-ID = maximum (binary complete "1")	Broadcast address of this network



Never choose an IP address with Host-ID=0 or Host-ID=maximum! (e.g. for class B with subnet mask = 255.255.0.0, the "172.16.0.0" is reserved and the "172.16.255.255" is occupied as local broadcast address for this network.)

6.6 Fast introduction

Overview

At the first commissioning respectively after an overall reset with PowerON again of the CPU, the Ethernet PG/OP channel has no IP address. This can only be reached by its MAC address. By means of the MAC address, which is printed at the front as 'MAC PG/OP:...', you can assign IP address data. The assignment takes place directly via the hardware configuration of the Siemens SIMATIC Manager.

Steps of configuration

For the configuration of the Ethernet PG/OP channel for productive connections please follow the following approach:

- Hardware configuration - CPU
- Hardware configuration - Ethernet PG/OP channel
- Configure connections
 - Siemens S7 connections
(Configuration via Siemens NetPro, communication via VIPA handling blocks)
 - Open communication
(Configuration and communication happens by standard handling blocks)
- Transfer of the complete project to CPU

6.7 Hardware configuration

Overview

At the first commissioning respectively after an overall reset with PowerON again of the CPU, the Ethernet PG/OP channel has no IP address. This can only be reached by its MAC address. By means of the MAC address, which is printed at the front as 'MAC PG/OP:...', you can assign IP address data. The assignment takes place directly via the hardware configuration of the Siemens SIMATIC Manager.

- CPU
 - ↳ *Chap. 4.4 'Hardware configuration - CPU' page 68*
- Ethernet PG/OP channel
 - ↳ *Chap. 4.6 'Hardware configuration - Ethernet PG/OP channel' page 71*

6.8 Configure Siemens S7 connections

Overview

The project engineering of connections i.e. the "link-up" between stations happens in NetPro from Siemens. NetPro is a graphical user interface for the link-up of stations. A communication connection enables the program controlled communication between two participants at the Industrial Ethernet. The communication partners may here be part of the same project or - at multi projects - separated within related part projects. Communication connections to partners outside of a project are configured via the object "In unknown project" or via deputy objects like "Other stations" or Siemens "SIMATIC S5 Station". The communication is controlled by the user program with VIPA handling blocks. To use this blocks, configured communication connections are always necessary in the active station.

↳ 'Link-up stations' page 172

↳ 'Projecting connections' page 173

↳ 'Siemens S7 connection - Communication functions' page 175

Properties communication connection

The following properties are characterizing a communication connection:

- One station always executes an active connection establishment.
- Bi-directional data transfer (Send and receive on one connection)
- Both participant have equal rights, i.e. every participant may initialize the send res. receive process event controlled.
- Except of the UDP connection, at a communication connection the address of the communication partner is set via the project engineering. Here the connection is active established by one station.

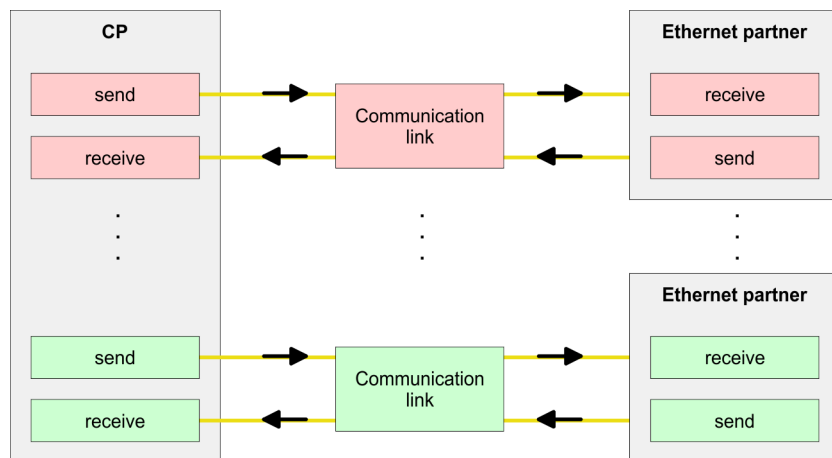

Requirements

- Siemens SIMATIC Manager V 5.5 SP2 or higher and SIMATIC NET are installed.
- With the hardware configuration the according CP was assigned with IP address data by its properties.



Every station outside of the recent project must be configured as replacement objects like e.g. Siemens "SIMATIC S5" or "other station" or with the object "In unknown project". When creating a connection you may also choose the partner type "unspecified" and set the required remote parameter directly in the connection dialog.

Work environment of NetPro

For the project engineering of connections, a thorough knowledge with NetPro from Siemens is required! The following passage only describes the basic usage of NetPro. More detailed information about NetPro is to be found in the according online manual res. documentation. Start NetPro by clicking on a "net" in the Siemens SIMATIC Manager or on "connections" within the CPU.

The environment of NetPro has the following structure:

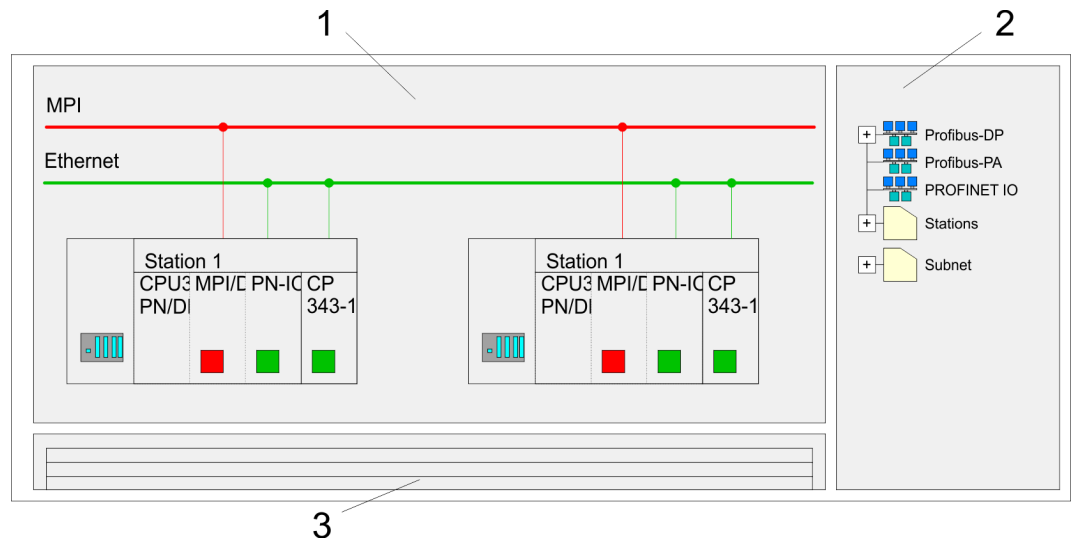

- 1 *Graphic net view:* All stations and networks are displayed in a graphic view. By clicking on the according component you may access and alter the concerning properties.
- 2 *Net objects:* This area displays all available net objects in a directory view. By dragging a wanted object to the net view you may include further net objects and open them in the hardware configurator.
- 3 *Connection table:* The connection table lists all connections in a table. This list is only shown when you highlighted a connectable module like e.g. a CPU. You may insert new connections into this table with the according command.

PLC stations

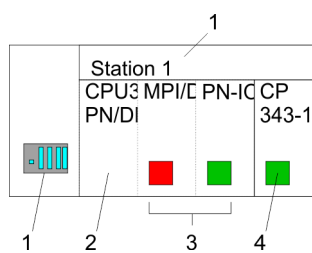

You receive the following graphical display for every PLC station and their component. By selecting the single components, the context menu offers you several functions:

- 1 *Station:* This includes a PLC station with rack, CPU and communication components. Via the context menu you may configure a station added from the net objects and its concerning components in the hardware configurator. After returning to NetPro, the new configured components are shown.
- 2 *CPU:* A click onto the CPU shows the connection table. The connection table shows all connections that are configured for the CPU.
- 3 *Internal communication components:* This displays the communication components that are available in your CPU. The PROFINET IO controller is to be configured by the PN-IO component.
- 4 *Ethernet PG/OP channel:* The internal Ethernet PG/OP channel must always be configured as external CP in the hardware configuration.

Link-up stations

NetPro offers you the option to link-up the communicating stations. You may link-up the stations via the properties in the hardware configuration or graphically via NetPro. For this you point the mouse on the coloured net mark of the according CP and drag and drop it to the net you want to link. Now the CP is linked up to the wanted net by means of a line.

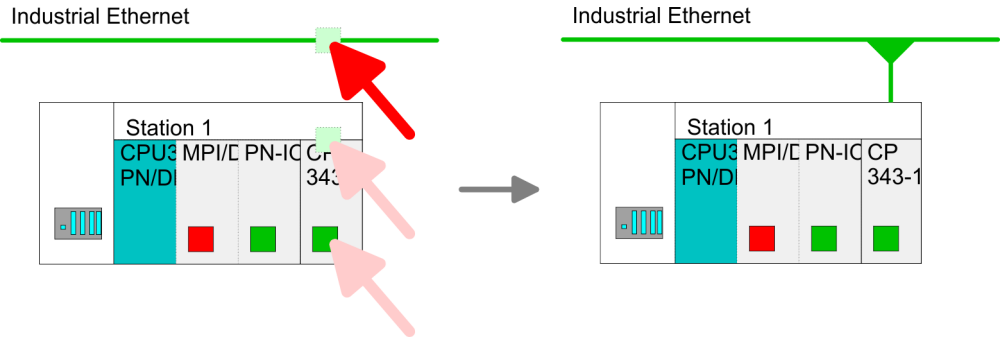

Projecting connections

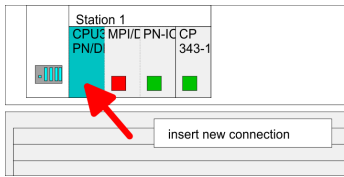

1. ➔ For the project engineering of connections, open the connection list by selecting the according CPU. Choose *Insert new connection* in the context menu:
 - *Connection partner (partner station)*
A dialog window opens where you may choose the connection partner and the *connection type*.
 - *Specified connection partner*
Each station configured in the Siemens SIMATIC Manager is listed in the table of connection partner. These stations are unique specified by an IP address and a subnet mask.
 - *Unspecified connection partner*
Here the connection partner may exist in the *current project* or in an unknown project. Connection jobs to an *unknown project* must be defined by an unique connection name, which is to be used in the projects of both stations. Due to this allocation the connection remains *unspecified*.
2. ➔ Choose the connection partner and the type of connection and confirm with [OK].
 - ⇒ If activated, a properties dialog for the according connection opens as link to your PLC user program.

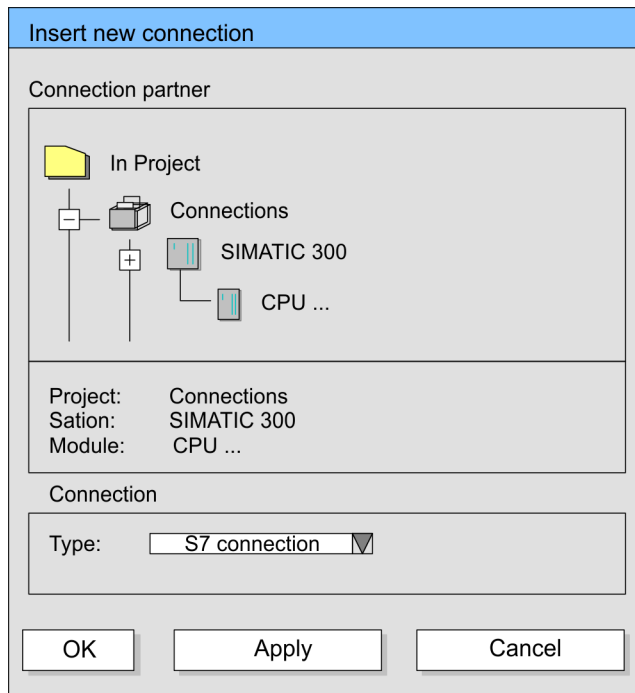

3. ➔ After every connection was configured by this way, you may save and compile your project and exit NetPro.

Configure Siemens S7 connections

Connection types With this CPU exclusively Siemens S7 connection may be configured with Siemens NetPro.

- Siemens S7 connection**
- For data transfer with Siemens S7 connections the FB/SFB VIPA handling blocks are necessary; the deployment is described in the manual "Operation list" of your CPU.
 - At Siemens S7 connections the communication connections are specified by a connection ID for each communication partner.
 - A connection is specified by the local and partner connection end point.
 - At Siemens S7 connections the TSAPs must be congruent crosswise. The following parameters define a connection end point:

The following parameters define a connection end point:

Station A				Station B
remote TSAP	→	Siemens	→	local TSAP
local TSAP	←	S7 connection	←	remote TSAP
ID A				ID B

Combination options with deployment of the FB/SFB VIPA handling blocks

Connection partner	Connection establishing	Connection
specified in NetPro (in the current project)	active/passive	specified
unspecified in NetPro (in the current project)	active	specified
	passive	unspecified
unspecified in NetPro (in the unknown project)	active/passive	specified (connection name in an other project)

In the following every relevant parameter of a Siemens S7 connection is described:

- *Local connection end point:*
Here you may define how the connection is to be established. Since the Siemens SIMATIC Manager can identify the communication options by means of the end points, some options are already preset and may not be changed.
 - *Establish an active connection:*
An established connection is precondition for data transfer. By activating the option Establish an active connection the local station establishes the connection. Please regard not every station is able to establish a connection. Here the job is to be made by the partner station.
 - *One-way:*
If activated only one-way communication blocks like PUT and GET may be used for communication in the user program. Here the partner station acts as server, which neither may send active nor receive active
- *Block parameters*
 - *Local ID:*
The ID is the link to your PLC program. The ID must be identical to the ID of the call interface of the FB/SFB VIPA handling block.
 - *[Default]:*
As soon as you click at [Default], the ID is reset to system generated ID.
- *Connection path:*
In this part of the dialog window the connection path between the local and the partner station may be set. Depending on the linking of the modules the possible interfaces for communication are listed in a selection field.
 - *[Address details]:*
With this button a dialog window is opened, which shows address information about the local and partner station. The parameters may also be changed.
 - *TSAP:*
With Siemens S7 connections a TSAP is automatically generated of the connection resource (one-way/two-way) and state of place (rack/slot respectively system internal ID at PC stations).
 - *Connection resource:*
The connection resource is part of the TSAP of the local station respectively of the partner. Not every connection resource may be used for every connection type. Depending on the connection partner and the connection type the range of values is limited respectively the connection resource is fix specified.

Siemens S7 connection - Communication functions

With the SPEED7 CPUs of VIPA there are two possibilities for the deployment of the communication functions:

- *Siemens S7-300 communication functions:*
By integration of the function blocks FB 12 ... FB 15 from VIPA you may access the Siemens S7-300 communication functions.
- *Siemens S7-400 communication functions:*
For the Siemens S7-400 communication functions the SFB 12 ... SFB 15 are to be used, which were integrated to the operating system of the CPU. Here copy the interface description of the SFBs from the standard library at system function block to the directory container, generate an instance data block for each call and call the SFB with the associated instance data block.

Function blocks

FB/SFB	Label	Description
FB/SFB 12	BSEND	<p>Sending data in blocks:</p> <p>FB/SFB 12 BSEND sends data to a remote partner FB/SFB of the type BRCV (FB/SFB 13). The data area to be transmitted is segmented. Each segment is sent individually to the partner. The last segment is acknowledged by the partner as it is received, independently of the calling up of the corresponding FB/SFB/FB BRCV. With this type of data transfer, more data can be transported between the communications partners than is possible with all other communication FBs/SFBs for configured S7 connections, namely 65534bytes.</p>
FB/SFB 13	BRCV	<p>Receiving data in blocks:</p> <p>The FB/SFB 13 BRCV can receive data from a remote partner FB/SFB of the type BSEND (FB/SFB 12). The parameter R_ID of both FB/SFBs must be identical. After each received data segment an acknowledgement is sent to the partner FB/SFB and the LEN parameter is updated.</p>
FB/SFB 14	GET	<p>Remote CPU read:</p> <p>The FB/SFB 14 GET can be used to read data from a remote CPU. The respective CPU must be in RUN mode or in STOP mode.</p>
FB/SFB 15	PUT	<p>Remote CPU write:</p> <p>The FB/SFB 15 PUT can be used to write data to a remote CPU. The respective CPU may be in RUN mode or in STOP mode.</p>

6.9 Configure Open Communication

You can use *Open Communication* to communicate with other users on the Ethernet via your user program. For this the following protocols are available.

Connection-oriented protocols

- Connection-oriented protocols establish a (logical) connection to the communication partner before data transmission is started.
- And if necessary they terminate the connection after the data transfer was finished.
- Connection-oriented protocols are used for data transmission when reliable, guaranteed delivery is of particular importance.
- In general, many logical connections can exist on one physical line.

The following connection-oriented protocols are supported with FBs for open communication via Industrial Ethernet:

- *TCP/IP native according to RFC 793 (connection types 01h and 11h):*
 - During data transmission, no information about the length or about the start and end of a message is transmitted.
 - The receiver has no means of detecting where one message ends in the data stream and the next one begins.
 - The transfer is stream-oriented. For this reason, it is recommended that the data length of the FBs is identical for the sending and receiving station.
 - If the number of received data does not fit to the preset length you either will get not the whole data, or you will get data of the following job. The receive block copies as many bytes into the receive area as you have specified as length. After this, it will set NDR to TRUE and write RCVD_LEN with the value of LEN. With each additional call, you will thus receive another block of sent data.
- *ISO on TCP according to RFC 1006:*
 - During data transmission, information on the length and the end of the message is also transmitted.
 - The transfer is block-oriented
 - If you have specified the length of the data to be received greater than the length of the data to be sent, the receive block will copy the received data completely into the receive range. After this, it will set NDR to TRUE and write RCVD_LEN with the length of the sent data.
 - If you have specified the length of the data to be received less than the length of the sent data, the receive block will not copy any data into the receive range but instead will supply the following error information: ERROR = 1, STATUS = 8088h.

Connection-less protocol

- There is thus no establishment and termination of a connection with a remote partner.
- Connection-less protocols transmit data with no acknowledge and with no reliable guaranteed delivery to the remote partner.

The following connection-oriented protocol is supported with FBs for open communication via Industrial Ethernet:

- *UDP according to RFC 768 (with connection type 13h):*
 - In this case, when calling the sending block you have to specify the address parameters of the receiver (IP address and port number).
 - During data transmission, information on the length and the end of the message is also transmitted.
 - In order to be able to use the sending and receiving blocks first you have to configure the local communications access point at both sides.
 - With each new call of the sending block, you re-reference the remote partner by specifying its IP address and its port number.
 - If you have specified the length of the data to be received greater than the length of the data to be sent, the receive block will copy the received data completely into the receive range. After this, it will set NDR to TRUE and write RCVD_LEN with the length of the sent data.
 - If you have specified the length of the data to be received less than the length of the sent data, the receive block will not copy any data into the receive range but instead will supply the following error information: ERROR = 1, STATUS = 8088h.

Handling blocks

Those in the following listed UTDs and FBs serve for "open communication" with other Ethernet capable communication partners via your user program. These blocks are part of the Siemens SIMATIC Manager. You will find these in the "Standard Library" at "Communication Blocks". Please consider when using the blocks for open communication that the partner station does not have to be configured with these blocks. This can be configured with AG_SEND/AG_RECEIVE or IP_CONFIG. First you have to establish a hardware configuration of the CPU and Ethernet PG/OP channel before you can use the handling blocks.

Configure Open Communication

Hardware configuration:

- CPU
 - ↳ Chap. 4.4 'Hardware configuration - CPU' page 68
- Ethernet PG/OP channel
 - ↳ Chap. 4.6 'Hardware configuration - Ethernet PG/OP channel' page 71

To specify the Ethernet PG/OP channel, the following values are defined in the UDT 65:

- *local_device_id*
 - 00h: Ethernet PG/OP channel of the CPU
- *next_staddr_len*
 - 01h: Ethernet PG/OP channel of the CPU
- *next_staddr*
 - 04h: Ethernet PG/OP channel of the CPU

UDTs

FB	Designation	Connection-oriented protocols: TCP native as per RFC 793, ISO on TCP as per RFC 1006	Connectionless protocol: UDP according to RFC 768
UDT 65*	TCON_PAR	Data structure for assigning connection parameters	Data structure for assigning parameters for the local communications access point
UDT 66*	TCON_ADR		Data structure for assigning addressing parameters for the remote partner

*) More information about the usage of these blocks may also be found in the manual "SPEED7 Operation List" from VIPA.

FBs

FB	Designation	Connection-oriented protocols: TCP native as per RFC 793, ISO on TCP as per RFC 1006	Connectionless protocol: UDP according to RFC 768
FB 63*	TSEND	Sending data	
FB 64*	TRCV	Receiving data	
FB 65*	TCON	Establishing a connection	Configuring the local communications access point
FB 66*	TDISCON	Terminating a connection	Closing the local communications access point
FB 67*	TUSEND		Sending data
FB 68*	TURCV		Receiving data

*) More information about the usage of these blocks may also be found in the manual "SPEED7 Operation List" from VIPA.

7 Deployment PG/OP communication - PROFINET



- With firmware version V2.4, there is a PROFINET IO controller available via the Ethernet PG/OP channel.
- As soon as you use the PROFINET functionality via the Ethernet PG/OP channel, this affects the performance and response time of your system and due to the system the cycle time of the OB1 is extended by 2ms.

7.1 Basics PROFINET

General

- PROFINET is an open Industrial Ethernet Standard from PROFIBUS & PROFINET International (PI) for automation.
- PROFINET is standardized in the IEC 61158.
- PROFINET uses TCP/IP and IT standards and supplements the PROFIBUS technology for applications, where fast data communication with industrial IT functions is demanded.

There are 2 PROFINET function classes:

- PROFINET IO
- PROFINET CBA

These may be realized in 3 performance steps:

- TCP/IP communication
- RT communication
- IRT communication

PROFINET IO

- With PROFINET IO an I/O data sight to the distributed periphery is described.
- PROFINET IO describes the whole data transfer between IO controller and IO device.
- PROFINET is configured like PROFIBUS.
- PROFINET IO always contains the real time concept.
- Contrary to the master-slave procedure of PROFIBUS, PROFINET uses the provider-consumer model. This supports the communication relations (AR = Application Relation) between equal participants in the Ethernet. Here the provider sends its data without a request of the communication partner.
- Apart from the user data exchange also functions for parametrization and diagnostics are supported.

PROFINET CBA

- PROFINET CBA means **C**omponent **B**ased **A**utomation.
- This component model describes the communication between autonomously working stations.
- It makes a simple modularization of complex plants possible, by distributed intelligence by means of graphic configuration for communication of intelligent modules.

TCP/IP communication

This is the open communication via Ethernet TCP/IP without any demand on real-time.

RT Communication

- RT means **R**eal-**T**ime.
- The RT communication represents the basics for data transfer at PROFINET IO.
- Here RT data are handled with higher priority.

- IRT Communication**
- IRT means **I**sochronous **R**eal-**T**ime.
 - With the IRT communication the bus cycle begins clock-exactly i.e. with a maximum permissible tolerance and is again synchronized. Thereby the time-controlled and synchronous transfer of data is guaranteed.
 - Here sync telegrams of a sync master in the network serve for.
- Properties of PROFINET**
- PROFINET of IEC 61158 has the following properties:
- Full-duplex transfer with 100MBit/s via copper respectively fibre optics.
 - Switched Ethernet
 - Auto negotiation (negotiates the transfer parameters)
 - Auto crossover (transmission and receipt lines are crossed automatically if necessary)
 - Wireless communication via WLAN
 - UDP/IP is used as overlaid protocol. UDP means **U**ser **D**atagram **P**rotocol and contains the unprotected connectionless broadcast communication within IP.
- PROFINET devices**
- Like PROFIBUS DP also with PROFINET IO the following devices are classified according to their tasks:
- IO controller
 - The *IO controller* is equivalent to the master of PROFIBUS.
 - This is the PLC with PROFINET connection, in which the PLC program runs.
 - IO device
 - The *IO device* is a distributed I/O field device, which is connected to PROFINET.
 - The IO device is equal to the slave of PROFIBUS.
 - IO supervisor
 - The *IO supervisor* is an engineering station as e.g. programming unit, PC or HMI interface for commissioning and diagnostics.
- AR**
- AR (**A**pplication **R**elation) corresponds to a connection to an IO controller or IO supervisor.
- API**
- API means **A**pplication **P**rocess Identifier and defines besides *Slot* and *Subslot* a further addressing level.
 - With this additional addressing mode with using of different applications, the overlapping of data areas can be prevented.
 - The following APIs are currently supported by the PROFINET IO devices from VIPA:
 - DEFAULT_API (0x00000000)
 - DRIVE_API (0x00003A00)
 - ENCODER_API (0x00003D00)
 - FIELDBUS_INTEGRATION_API (0x00004600)
 - PROFINET_IO_LINK_API (0x00004E01)
 - RFID_READER_API (0x00005B00)
 - BARCODE_READER_API (0x00005B10)
 - INTELLIGENT_PUMP_API (0x00005D00)
- GSDML file**
- To configure a device I/O connection in your own configuration tool, you've got all the information about your PROFINET components in form of a GSDML file. This file may be found for System MICRO in the download area of www.vipa.com at '*Config files* → *PROFINET*'.
 - Please install the GSDML file in your configuration tool.

- More information about installing the GSDML file may be found at the manual of the according engineering tool.
- Structure and content of the GSDML file are defined by IEC 61158.

Addressing

In contrast to the PROFIBUS address, in PROFINET each device may be definitely identified with its PROFINET interface:

- Device name
- IP address respectively MAC address

Transfer medium

PROFINET is compatible to Ethernet in accordance with the IEEE standards. The connection of the PROFINET IO field devices is exclusively established via switches as network components. This is made either as star via multi-port switches or as line by means of switches, integrated to the field devices.

7.2 PROFINET installation guidelines

Generals to data security

The topic of data security and access protection have become increasingly important in the industrial environment. The increased networking of entire industrial systems to the network levels within the company together with the functions of remote maintenance have all served to increase vulnerability. Threats can arise from internal manipulation like technical errors, operator and program errors respectively from external manipulation like software viruses and worms, trojans and password phishing.

Precautions

The most important precautions to prevent manipulation and loss of data security in the industrial environment are:

- Encrypting the data traffic by means of certificates.
- Filtering and inspection of the traffic by means of VPN - "Virtual Private Networks".
- Identification of the nodes by "Authentication" via save channels.
- Segmenting in protected automation cells, so that only devices in the same group can exchange data.

Guidelines for information security

With the "VDI/VDE 2182 sheet 1", Information Security in the Industrial Automation - General procedural model, VDI guidelines, the VDI/VDE society for measuring and automation engineering has published a guide for implementing a security architecture in the industrial environment. The guideline can be found at www.vdi.de PROFIBUS & PROFINET International (PI) can support you in setting up security standards by means of the "PROFINET Security Guideline". More concerning this can be found at the corresponding web site e.g. www.profibus.com

Industrial Ethernet

- Due to the open standard of PROFINET standard Ethernet components may be used.
- For industrial environment and due to the high transfer rate of 100MBit/s your PROFINET system should consist of Industrial Ethernet components.
- All the devices interconnected by switches are located in one and the same network. All the devices in a network can communicate directly with each other.
- A network is physically limited by a router.
- If devices need to communicate beyond the limits of a network, you have to configure the router so that it allows this communication to take place.

Topology

- Linear
 - With the linear structure all the communication devices are connected via a linear bus topology.
 - Here the linear bus topology is realized with switches that are already integrated into the PROFINET device.
 - If a communication member fails, communication across the failed member is no longer possible.
- Star
 - If you connect communication devices to a switch with more than 2 PROFINET interfaces, you automatically create a star network topology.
 - If an individual PROFINET device fails, this does not automatically lead to failure of the entire network, in contrast to other structures.
 - It is only if a switch fails that part of the communication network will fail as well.
- Ring
 - In order to increase the availability of a network the both open ends of a linear bus topology may be connected by a switch.
 - By configuring the switch as redundancy manager on a break in the network it ensures that the data is redirected over an intact network connection.
- Tree
 - If you interconnect several star structures, you obtain a tree network topology.

7.3 Deployment as PROFINET IO controller**7.3.1 Steps of configuration**

- With firmware version V2.4, there is a PROFINET IO controller available via the Ethernet PG/OP channel.
- As soon as you use the PROFINET functionality via the Ethernet PG/OP channel, this affects the performance and response time of your system and due to the system the cycle time of the OB1 is extended by 2ms.

**Range of functions**

Please regard that the PROFINET IO controller supports only the PROFINET functions, which are described in this manual, even if the Siemens CPU, which is used for configuration, offers further functions! To use some described PROFINET functions, it is necessary to deploy another Siemens CPU for configuration. Here, however, is pointed to explicitly.

The configuration of the PROFINET IO controller for PROFINET communication should be done by the following procedure:

1. ➤ Commissioning and Initialization (assignment IP address data)
2. ➤ Hardware configuration - CPU
3. ➤ Configuration PROFINET IO controller
4. ➤ Configuration PROFINET IO devices



With the Siemens SIMATIC Manager, the CPU M13-CCF0000 from VIPA is to be configured as

CPU 314C-2 PN/DP (314-6EH04-0AB0 V3.3)

!

7.3.2 Commissioning and initialization

Assembly and commissioning

1. ➤ Install your System MICRO with your CPU.
2. ➤ Wire the system by connecting cables for voltage supply and signals
3. ➤ Connect your PROFINET IO controller with Ethernet.
4. ➤ Switch on the power supply.

⇒ After a short boot time, the CP is in idle.

At the first commissioning respectively after an overall reset of the CPU, the Ethernet PG/OP channel has no IP address.

Assign IP address parameters

This function is supported only if the PROFINET IO controller is not yet configured. You get valid IP address parameters from your system administrator. The assignment of the IP address data happens online in the Siemens SIMATIC Manager starting with version V 5.5 & SP2 with the following proceeding:

1. ➤ Start the Siemens SIMATIC Manager.
2. ➤ Switch to "TCP/IP -> Network card" using 'Options → Set PG/PC interface →'.
3. ➤ Open the dialog for initialization of a station with 'PLC → Edit Ethernet node'.
4. ➤ To get the stations and their MAC address, use the [Browse] button or type in the MAC address. The Mac address may be found at the front of the CPU.
5. ➤ Choose if necessary the known MAC address of the list of found stations.
6. ➤ Either type in the IP configuration like IP address, subnet mask and gateway. Or your station is automatically provided with IP parameters by means of a DHCP server. Depending of the chosen option the DHCP server is to be supplied with MAC address, equipment name or client ID. The client ID is a numerical order of max. 63 characters. The following characters are allowed: Hyphen "-", 0-9, a-z, A-Z
7. ➤ Confirm with [Assign IP configuration].

Directly after the assignment the PROFINET IO controller is online reachable using the set IP address data. You can take the IP address data to your project by means of the hardware configuration. ↪ *Chap. 4.4 'Hardware configuration - CPU' page 68*

7.3.3 Configuration PROFINET IO controller

7.3.3.1 Precondition

To parameterize the PROFINET IO controller of the CPU, the following conditions must be fulfilled:

- The PROFINET IO controller is online reachable, this means an initialization was established.
- The hardware configuration described before was established and the PROFINET IO controller is networked.

Proceeding

➔ Open the properties dialog of the PROFINET IO controller by a double-click at PN-IO.

1	
2	CPU ...
X...	PN-IO
3	

PROFINET-IO-System

The PROFINET interface of the PROFINET IO controller is parameterized with PN-IO, the port with Port 1. In the following these parameters for PN-IO and Port 1 are described.

7.3.3.2 PN-IO**Tab: 'General'****Short description**

Designation of the IO controller. For the IO controller of VIPA, the *short description* is "PN-IO".

Device name

The device name on the Ethernet subnet must be unique. During initialization the device name is derived from the short description. You can change this at any time.

Support device replacement without exchangeable medium

This parameter is not evaluated. With configured topology the *device replacement without exchangeable medium* is supported. ↪ *Chap. 7.7 'Device replacement without exchangeable medium/PG' page 195*

Properties

With *properties* you can enter the IP address, subnet mask and gateway for the PROFINET interface and select the subnet to be connected.

Tab: 'Addresses'

The CPU reports errors of the IO controller via the *interface address*, as soon as e.g. an error during synchronization of the IO controller occurs. With the *PROFINET IO system address* the CPU reports e.g. failure/return of the PROFINET IO system. This address is also used to identify the IO system to which the device belongs, if an IO device fails.

Tab: 'PROFINET'

With the operation field "OB82 / I/O fault task..." you can cause the CPU to call the OB 82 at an error event of the PROFINET interface. An entry to the diagnostics buffer is always done. The other parameters here are not relevant for the use of the VIPA PROFINET CPU.

Tab: 'I-Device'

These settings are not required for the use of the PROFINET IO controller as an I-Device and should not be changed. ↪ *Chap. 7.4 'Deployment as PROFINET I-Device' page 186*

Tab: 'Synchronization'

These settings are not relevant and should not be changed.

Tab: 'Media Redundancy' (MRP)

MRP is supported exclusively as a *redundancy client*. ↪ *Chap. 7.5 'MRP' page 193*

- Tab: 'Time-of-day synchronization'** In this area you can configure time-of-day master for time-of-day synchronization in the network. ↪ *Chap. 4.6.1.1.1 'Time-of-day synchronization' page 74*
- Tab: 'Options'**
- Interval** Here you can set the interval time with which "Keep-Alive" telegrams are to be sent to a connection partner. This ensures that a communication partner can still be reached because the connection resources are automatically released again after the expiration *interval* time.
- 7.3.3.3 Port 1**
- Tab: 'General'** Shown is the short name "Port...". In the field Name another designation may be selected, which is also shown in the configuration table At *comment* you may describe your entry near more. The comment also appears in the configuration table.
- Tab: 'Addresses'** Via the *port* address the diagnostics information of the IO controller may be accessed.
- Tab: 'Topology'** These parameters serve for the port setting for topology. ↪ *Chap. 7.6 'Topology' page 194*
- Tab: 'Options'** These parameters serve for the port setting. Here the following parameters are supported:
- Connection
 - Here you can make settings for transmission medium and type. Ensure that the setting for the local port and the partner port are identical.
 - PROFINET requires 100Mbit/s in duplex mode.
 - Boundaries
 - *Boundaries* are limitations for the transfer of certain Ethernet frames. The following *Boundaries* are supported:
 - '*End of detection of accessible nodes*': DCP frames for detecting accessible nodes are not forwarded. When enabled, participants which are lying behind this port, are no longer recognized and can not be reached by the controller.
 - '*End of topology discovery*': When enabled, this port does not support topology discovery, i.e. LLDP frames are not forwarded.

7.3.4 Configuration PROFINET IO device

- Precondition** The modules, which may be configured here are listed in the hardware catalog.
- For the deployment of the PROFINET IO devices from VIPA you have to include the modules into the hardware catalog by means of the GSDML file from VIPA.
 - After the installation of the GSDML file the PROFINET IO devices from VIPA may be found in the hardware catalog at '*PROFINET IO* ➔ *Additional field devices* ➔ *I/O* ➔ *VIPA ...*'

Configure IO devices

Now the project engineering of the PROFINET IO controller is finished. Please link up now your IO devices with periphery to your IO controller.

1. ➔ For the project engineering of PROFINET IO device you search the concerning PROFINET IO device in the hardware catalog at *PROFINET-IO* and drag&drop it in the subnet of your IO controller.
2. ➔ Assign a name to the IO device. The configured name must match the name of the device. Information about setting the device name can be found in the manual of the IO device.
3. ➔ Enter a valid IP address. The IP address is normally assigned automatically by the hardware configurator. If this is not desired, you can assign the IP address manually.
4. ➔ Link up the modules of your IO device in the plugged sequence and add the addresses that should be used by the modules.
5. ➔ If needed, parametrize the modules.
6. ➔ Save, compile and transfer your project. ↪ *Chap. 4.9 'Project transfer' page 81*

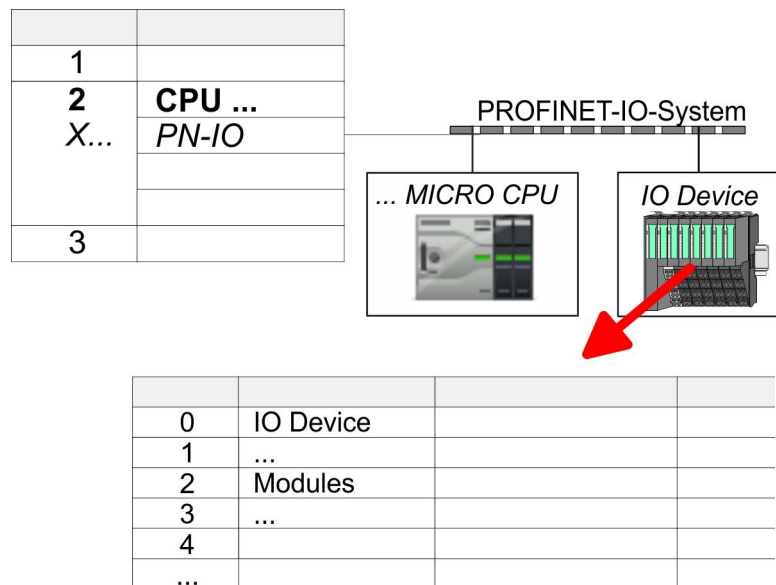

7.4 Deployment as PROFINET I-Device

7.4.1 Steps of configuration

Functionality



- *With firmware version V. 2.4, there is a PROFINET IO controller available via the Ethernet PG/OP channel, which can be configured as I-Device.*
- *As soon as you use the PROFINET functionality via the Ethernet PG/OP channel, this affects the performance and response time of your system and due to the system the cycle time of the OB1 is extended by 2ms.*



Range of functions

Please regard that the PROFINET IO controller supports only the PROFINET functions, which are described in this manual, even if the Siemens CPU, which is used for configuration, offers further functions! To use some described PROFINET functions, it is necessary to deploy another Siemens CPU for configuration. Here, however, is pointed to explicitly.

The I-Device (Intelligent IO device) functionality of a CPU allows data to be exchanged with an IO controller, which are preprocessed by the CPU. In this case, the I-Device is connected as an IO device to a higher-level IO controller. The process values recorded in central or decentralized periphery can be preprocessed via a user program and made available to the higher-level PROFINET IO controller by means of PROFINET.

- The configuration of the integrated PROFINET IO controller of the VIPA CPU as an I-Device is made via a virtual PROFINET devices, which is to be installed by means of a GSDML from VIPA in the hardware catalog.
- The communication takes place via input/output areas, which are defined in the I-Device.
- The size of the areas for input and output data is max. 768byte.
- The I-Device is made available to a deterministic PROFINET IO system via a PROFINET IO interface and thus supports the real-time communication *Real-Time*.
- The I-Device functionality meets the requirements of the RT class I (A) and corresponds to the PROFINET specification version V2.3.
- The configuration of a VIPA PROFINET CPU as an IO controller and at the same time as an I-Device is possible. The influence of the I-Device configuration on the system limits or performance of the PROFINET controller is equated with that of a device. This means that when the IO controller and I-Device are used at the same time on the PROFINET controller, the I-Device is to be regarded as an additional device for determining the system limits.
- In order for the higher-level IO controller to communicate with the VIPA I-Device, the following must be observed:
 - I-Device and higher-level IO controllers must be configured in different networks. Their IP addresses must be in the same IP circuit.
 - The device name of the PROFINET controller of the I-Device must match the device name of the I-Device at the higher-level IO controller.

Configuration

The configuration of the PROFINET IO controller as I-Device should be done by the following procedure:

1. ➤ Installation of the GSDML files
2. ➤ Configuration as I-Device
3. ➤ Configuration in the higher-level IO controller

7.4.2 Installing the GSDML file

The following GSDML files are required for configuring the integrated PROFINET IO controller of the VIPA CPU as I-Device in the Siemens SIMATIC Manager:

- GSDML for I-Device
- GSDML for I-Device at IO controller

Proceeding

1. You can find the GSDML files in the download area of www.vipa.com. Load the file and unzip it on your PC.
2. Start the Siemens SIMATIC Manager and install via 'Options → Install new GSD file' both GSD files.
 - ⇒ After the installation you can find the following virtual devices in the *hardware catalog* at 'PROFINET IO → Additional field devices → ... → VIPA MICRO System':
 - PN I-Device for VIPA CPU
 - This allows you to configure the Input/output areas in the I-Device of the VIPA CPU.
 - PN I-Device for higher-level CPU
 - This allows you to connect the VIPA I-Device to the higher-level IO controller.

7.4.3 Configuration as I-Device

It is assumed that a hardware configuration of the CPU exists. ↗ Chap. 4.4 'Hardware configuration - CPU' page 68

1. For the project engineering of PROFINET I-Device you have to search the virtual device 'PN I-Device for VIPA CPU' in the hardware catalog at PROFINET-IO and drag&drop it in the PROFINET subnet.

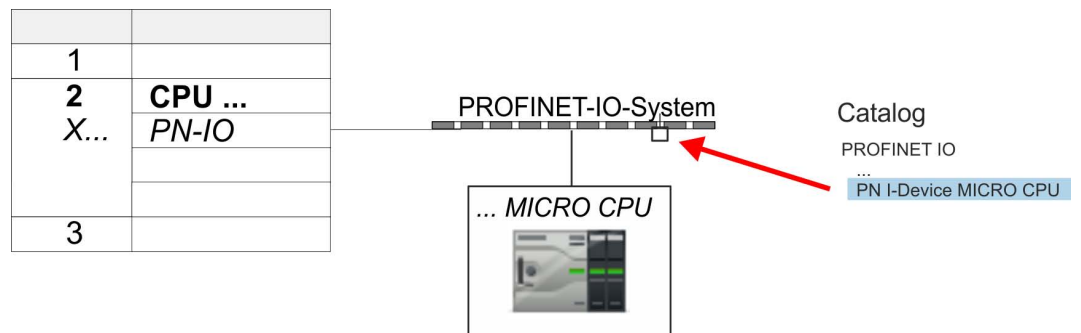

2. Open the properties dialog of the PROFINET IO controller of the CPU by a double-click at 'PN-IO' and assign the name for the I-Device.

i Write down the Name. This name must also be specified as the 'device name' of the I-Device for the higher-level IO controller.

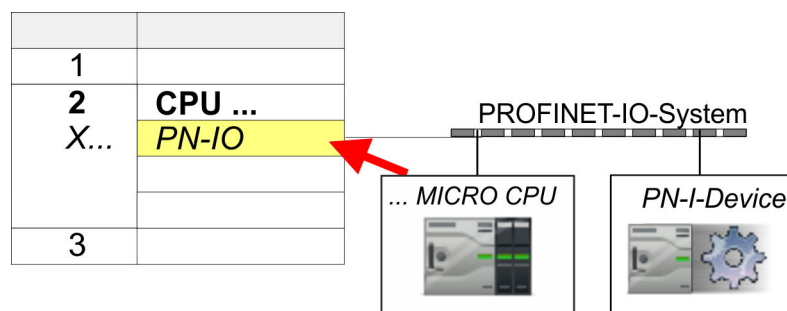

3. For 'PN-IO' at 'slot' 'X...' assign an IP address via the properties dialog.

4. ➔ Create the transfer areas by dragging them to the 'slots' as I/O areas from the hardware catalog. There must be no gaps in the slots. To create the transfer areas, the following input and output areas are available that can be assigned to the virtual I-Device:

- Input: 1, 8, 16, 32, 64, 128, 256, 512 byte
- Output: 1, 8, 16, 32, 64, 128, 256, 512 byte

The data direction for *Input* or *Output* refers to the view of the I-Device.

- *Input* areas define data that are sent from the higher-level IO controller to the I-Device and which are mapped to the input address area of the CPU.
- *Output* areas define data that are sent to the higher-level IO controller and which are to stored in the output address area of the CPU.

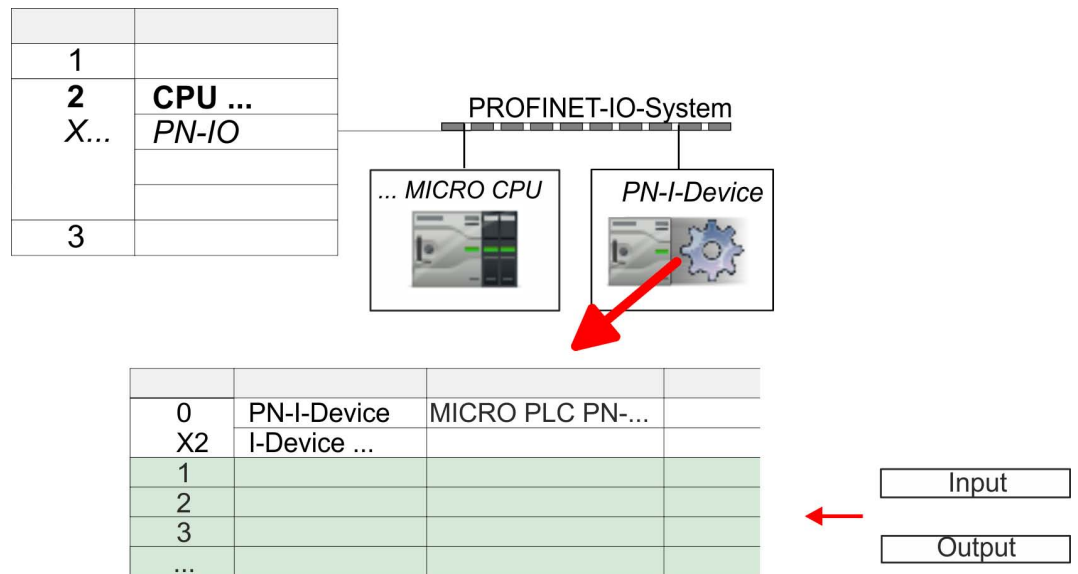

5. ➔ Save and transfer your project to the CPU.

7.4.4 Configuration in the higher-level IO controller

It is assumed that a CPU is configured with IP address with the higher-level IO controller. The IP address must be in the same IP circuit as the IP address of the I-Device.

1. ➔ Open the project of the CPU with the higher-level IO controller.
2. ➔ For the project engineering of VIPA I-Device in the high-level IO controller you have to search the device 'PN I-Device for high-level CPU' in the hardware catalog at PROFINET-IO and drag&drop it in the PROFINET subnet.

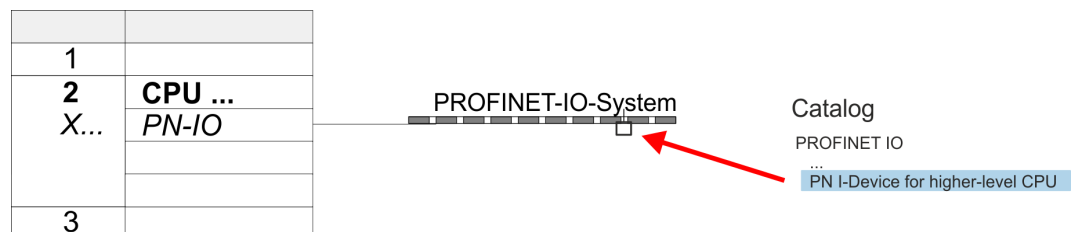

3. → Open the properties dialog by double-clicking 'PN-I-Device' and enter at 'device name' the previously noted name of the VIPA I-Device.



The configured name must match the name of the PROFINET IO controller 'PN-IO' of the I-Device CPU, which you have noted before! ↪ Chap. 7.4.3 'Configuration as I-Device' page 188

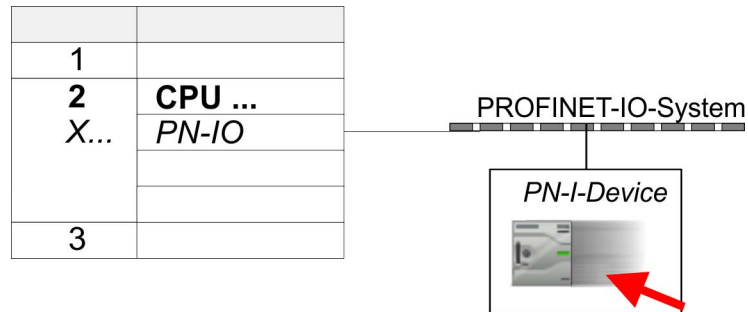

4. → Configure an input area of the same size for each output area of the I-Device in the IO controller and vice versa. Here also no gaps may arise. In particular, make sure that the order of the transfer areas matches that of the I-Device configuration. The following transfer units are available:
- Input: 1, 8, 16, 32, 64, 128, 256, 512 byte per slot
 - Output: 1, 8, 16, 32, 64, 128, 256, 512 byte per slot
5. → Save and transfer your project to the CPU.
- ⇒ Your VIPA PROFINET controller is now connected as an I-Device to the higher-level PROFINET IO controller.



I-Device with S7 routing

S7 routing is not possible with the procedure above. S7 routing is only possible if the I-Device and the higher-level I/O controller are configured in the same network. The device names must not be identical. By using identical names and extending the name of the I-Device with "-x", this is detected internally and used appropriately for S7 routing.

7.4.5 Error behavior and interrupts

Error behavior

The system shows the following error behavior ...

- ... at gaps in the 'slot' configuration:
 - If the configuration of the I-Device contains gaps in the 'slot' configuration (i.e. there are free 'slots' before used 'slots'), the configuration is rejected and 0xEA64 is returned as a configuration error in the diagnostic buffer.
 - If the configuration of the higher-level IO controller contains gaps in the 'slot' configuration (i.e. there are free 'slots' before used 'slots'), the connection is rejected with the PN IO Status *ErrorCode1* = 0x40 and *ErrorCode2* = 0x04 (AR_OUT_OF_RESOURCE).
- ... at modules, which differ from the configured:
 - A *ModuleDiffBlock* is generated and the wrong modules are not served.

- ... if the number of configured modules in the IO controller is greater than the number of configured modules in the I-Device:
 - The IO controller receives a *ModuleDiffBlock* with *ModuleStatus* "NoModule" for modules that are not configured in the I-Device. The I-Device sets the status of the non-configured modules to "bad".
- ... if the number of configured modules in the I-Device is greater than the number of configured modules in the IO controller:
 - The IO controller does not receive an error because the additional modules are unknown.

Starting position	IO controller in RUN, I-Device in RUN
Event	I-Device CPU goes to STOP
Reaction	<ul style="list-style-type: none"> ■ An OB 85 is called in the IO controller for each input and output transfer area, which is located in the process image, if messages of process image transfer errors are parametrized. ↪ 78 ■ An OB 122 is triggered in the IO controller for each peripheral direct access to an input or output transfer area.

Starting position	IO controller in RUN, I-Device in RUN
Event	IO controller goes to STOP
Reaction	<ul style="list-style-type: none"> ■ An OB 85 is called in the I-Device for each input transfer area, which is located in the process image, if messages of process image transfer errors are parametrized. ↪ 78 ■ In the I-Device, an OB 122 is triggered for each peripheral direct access to an input transfer area.
	Note: Output transfer areas can still be accessed!

Starting position	IO controller in RUN, I-Device in RUN
Event	Station failure I-Device, e.g. by bus interruption
Condition	I-Device must remain operational without a bus connection, i.e. the power supply must further exist.
Reaction	<ul style="list-style-type: none"> ■ An OB 86 (station failure) is called up in the IO controller. ■ An OB 85 is called in the IO controller for each input and output transfer area, which is located in the process image, if messages of process image transfer errors are parametrized. ↪ 78 ■ An OB 122 is triggered in the IO controller for each peripheral direct access to an input or output transfer area. ■ An OB 86 (station failure) is called up in the I-device. ■ An OB 85 is called in the IO controller for each input and output transfer area, which is located in the process image, if messages of process image transfer errors are parametrized. ↪ 78 ■ In the I-device, an OB 122 is triggered for each peripheral direct access to an input or output transfer area.

Starting position		IO controller in RUN, I-Device in RUN
Event		Station recovery
Reaction		<ul style="list-style-type: none"> ■ An OB 86 (recovery) is called in the IO controller. ■ An OB 85 is called in the IO controller until the OB 86 has been called, for each input and output transfer area, which is in the process diagram, if messages of process image transfer errors are parametrized. ↪ 78 ■ An OB 122 is triggered in the IO controller until the OB 86 is called, for each peripheral direct access to an input or output transfer area. ■ An OB 86 (return) is called in the I-Device. ■ An OB 83 (sub module recovery) is called for each input transfer area in the I-Device. ■ In the I-device, an OB 85 is called for each input transfer area, which is in the process image, if messages of process image transfer errors are parametrized and the corresponding OB 83 has not yet been called. ↪ 78 ■ An OB 122 is triggered in the I-Device for each peripheral direct access to an input transfer area, until the corresponding OB 83 has been called.
Starting position		Controller in RUN, I-Device in STOP
Event		I-Device starts
Reaction		<ul style="list-style-type: none"> ■ The OB 100 (start-up) is called in the I-Device. ■ The OB 83 (Return-of-Submodule) for input sub modules of the transfer areas to the higher-level IO controller is called in the I-Device. ■ An OB 85 is called in the I-device for each input transfer area, which is located in the process image, if messages of process image transfer errors are parametrized. ↪ 78 ■ In the I-Device, an OB 122 is triggered for each peripheral direct access to an input transfer area. ■ OB 83 (Return-of-Submodule) for input and output sub modules of the transfer areas to the I-Device is called in the IO controller. ■ An OB 85 is called in the IO controller for each input and output transfer area, which is located in the process diagram, if messages of process image transfer errors are parametrized and the corresponding OB 83 has not yet been called. ↪ 78 ■ In the IO controller, an OB 122 is triggered for each peripheral direct access to an input or output transfer area until the corresponding OB 83 has been called.
Starting position		IO controller is in STOP, I-Device in RUN
Event		IO controller starts
Reaction		<ul style="list-style-type: none"> ■ The OB 83 (Return-of-Submodule) for input sub modules of the transfer areas to the higher-level IO controller is called in the I-Device. ■ An OB 85 is called for each transfer area, which is located in the process image, in the I-device if messages of process image transfer errors are parametrized and the corresponding OB 83 has not yet been called. ↪ 78 ■ An OB 122 is triggered in the I-Device for each peripheral direct access to an input transfer area, until the corresponding OB 83 has been called. ■ The OB 100 (startup) is called in the IO controller.

7.5 MRP

Overview

To increase the network availability of an industrial Ethernet network, you can connect a *line topology* together to a *ring topology*. To set up a ring topology with media redundancy, you have to bring together the two free ends of a linear bus topology in one device. Closing the linear bus topology to form a ring is achieved with two ports (ring ports) of a device in the ring. At least one device of the ring takes the role of the *redundancy manager*. All other devices in the ring are *redundancy clients*. A standard media redundancy method is MRP (Media Redundancy Protocol). Up to 50 devices per ring can participate. The MRP (**M**edia **R**edundancy **P**rotocol) is specified in the standard IEC 61158 Type 10 "PROFINET".

Precondition

- The ring in which you want to use MRP may consist only of devices that support this function.
- "MRP" must be activated for all devices in the ring.
- All devices must be connected via their ring ports.
- The ring may contain max. 50 devices.
- The connection setting (transmission medium/duplex) must be set to "full duplex" and at least 100Mbit/s for all ring ports. Otherwise there may be a loss of data traffic.

Function

- The data paths between the individual devices are automatically reconfigured if the ring is interrupted at any point. After reconfiguration, the devices are accessible again.
- In the redundancy manager, one of the both ring ports are blocked for uninterrupted network operation for normal communication so that no data telegrams are circulated. In terms of data transmission, the ring topology is a linear bus topology.
- The *redundancy manager* monitors the ring for interruptions. For this he sends test frames from both ring port 1 and ring port 2. The test frames run through the ring in both directions until they arrive at the other ring port of the redundancy manager.
- As soon as the interruption is removed, the original transmission paths are restored, the two ring ports of the redundancy manager are disconnected and the redundancy clients informed of the change. The redundancy clients then use the new paths to the other devices.

Reconfiguration time

The time between the ring interruption and restoration of a functional linear topology is known as the *reconfiguration time*. At *MRP* the *reconfiguration time* is typically 200ms.

VIPA PROFINET CP as redundancy client

MRP is only supported as *redundancy client*. If the ring is opened or closed, you will be informed via the OB 82 "Neighbourhood change". With SFB 54 you can get more information.



The use of MRP in the operating mode I-Device is not permissible and is rejected during the configuration!

7.6 Topology

Overview

By configuring the topology you specify for the PROFINET IO controller the physical connections between the stations in your PROFINET IO system. These "neighbourhood relations" are used among others at "Device replacement without exchangeable medium". Here by comparison of target and current topology, the IO device without a name is detected and automatically integrated to the user data traffic. By configuring the topology you have the following options:

- You can evaluate topological errors in your application program
- You have greater flexibility in planning and expansion of a plant



Support Topology editor is limited

Please consider that the support for the topology editor of the Siemens SIMATIC Manager is limited. Here you have only the possibility to configure the target topology offline. An online matching is currently not possible. An interconnection of the ports is also possible by means of the port properties!

Interconnection by means of the *Port* properties

1. Click in the hardware configurator at the according PROFINET port and open the properties dialog via 'Context menu → Object properties' and select the register 'Topology'.
 - ⇒ The properties dialog to interconnect the ports is opened.
2. Here you have the following parameters:
 - Port interconnection
 - Local port: Name of the local port
 - Medium: Specifying the line type (copper, fibre optic cable). Currently, this parameter is not evaluated.
 - Cable name Specifying a cable name
 - Partners
 - Partner port: Name of the port to which the selected port is interconnected.
 - Alternating partner ports: By specifying at 'Partner port' "Any partner", you can configure alternating partner ports for the I/O devices. Currently, this parameter is not evaluated.
 - Cable data
 - Cable length: Depending on the port medium you can set in the select list the cable length, if the medium between two stations does not change. Here the signal delay time is automatically calculated. Currently, this parameter is not evaluated.
 - Signal delay time: If the medium between two stations changes, a signal delay time can be defined here. Currently, this parameter is not evaluated.
3. Close the properties dialog with [OK] again.

7.7 Device replacement without exchangeable medium/PG

Overview

IO devices, which support the PROFINET function *Device replacement without exchangeable medium/PG* get their device name from the controller with the exchange. These can be replaced without installing an "exchangeable medium" (memory card) with the stored device name respectively without assigning a device name by a PG. To assign the device name the IO controller uses the configured *Topology* and the "neighbourhood relationship", which is determined by the IO devices.

Thus the *Device replacement without exchangeable medium/PG* is possible, the following requirements must be met:

- The *Topology* of your PROFINET IO system with the corresponding IO devices must be configured.
- The IO controller and the respective adjacent to the unit to be replaced IO device must support the functionality *Device replacement without exchangeable medium/PG*.
- In the IO controller in the '*Properties*' the option *Support device replacement without exchangeable medium* must be enabled.
- The replaced device must be reset to delivery state, before.

Configuring the function

The configuration of the function *Device replacement without exchangeable medium/PG* in your PROFINET IO system happens with the following approach:

1. ➤ Double-click at the PROFINET interface of the IO controller of the CPU.
⇒ The properties dialog of this PROFINET interface is opened
2. ➤ Enable in the register '*General*' the option '*Support device replacement without exchangeable medium*'.
3. ➤ Apply the settings with [OK].
4. ➤ Save and translate the hardware configuration.
5. ➤ Configure your *Topology*. ↪ *Chap. 7.6 'Topology' page 194*
6. ➤ Transfer your project to the CPU.

Prepare the replace device

For the replacement the "replace device" must be in "delivery state". If you have not received a new "replace device" from VIPA, you have to prepare this with the following approach:

1. ➤ For this connect your "replace device" local at your PG.
2. ➤ Start the Siemens SIMATIC Manager and execute '*PLC → Edit Ethernet node*'
3. ➤ Click at '*Nodes accessible online*' at [Browse].
4. ➤ Select the according IO device, which you identify as your "replace device".
5. ➤ Click at '*Reset to factory settings*' at [Reset].
⇒ Your IO device is now reset and has then "delivery state".

Replace device

For the replacement the "replace device" must be in "delivery state".

1. ➤ Disconnect if not already done your device to be exchanged from power.
2. ➤ Replace this by your "replace device".
3. ➤ Connect the "replaced device" to power and turn it ON.
⇒ Here by comparison of target and current topology, the "replaced device" is automatically detected by the IO controller and automatically integrated to the user data traffic.

7.8 Commissioning and start-up behavior

- Start-up on delivery state** In the delivery state the CPU is overall reset. After power ON the PROFINET part has no configuration the PROFINET has no configuration. The PROFINET part is passive and can be found by the device search.
- Online with bus parameters without project**
- For the communication between IO controller and IO device the ways for the communication are to be defined before. For the clear specification of the communication ways, these are established during the start-up by the IO controller, based on the project data. Here the configuration takes place by a hardware configuration.
 - As soon as the project data were transmitted, the IO controller performs a new system start-up.
 - In this state the IO controller may be accessed and its CPU may be configured via Ethernet by the IO controller by means of the IP address.
- IO device configuration**
- The PROFINET IO controller is configured by a hardware configuration. After the transmission of the project into the IO controller, the IO controller has the whole information for the addressing of and the data exchange with the IO devices.
 - During the system start-up of the IO controller the IO devices are supplied with their configured IP address by means of the DCP protocol. After PowerON and after transmitting a new hardware configuration, due to the project data the system start-up of the IO controller is initialized and it runs automatically. During the system start-up the IO controller establishes a clear communication relation (CR) and an application relation (AR) to an IO device. Here the cyclic IO data, the acyclic R/W services and the expected modules/sub modules are specified.
 - The PROFINET IO controller does not have any physical LEDs to show the status. The status information are stored as virtual LED states. During runtime, you can determine their status using the SSL partial lists xy19h or xy74h. ↪ *Chap. 7.9.5 'Diagnostics status indication via SSLs' page 199*
 - The BF3 LED is on when a PROFINET IO device is configured as "linked" but a bus cable is connected.
 - If the IO controller has received a valid configuration with at least one IO device, the BS2-LED gets on.
 - With Ethernet interface parameters, which are unsuitable for PROFINET operation, the BS2-LED flashes at 1Hz.
 - If the IP address of the IO controller can not be used because e.g. it is duplicated, the BS2-LED flashes at 0.5Hz.
 - If at least one IO device is not in cyclic data exchange after the start-up, the BF3 LED blinks.
 - If all IO devices are in cyclic data exchange, the BF3 LED gets off. After a successful system start-up the system is ready for communication.
- CPU state influences the IO process data**
- After PowerON respectively a receipt of a new hardware configuration the configuration data are automatically transferred to the IO controller. Dependent on the CPU state the following behavior is shown by the IO controller:
- Behavior at CPU STOP
 - In the STOP state of the CPU an output telegram is further cyclically sent, but the contained data are marked as "invalid" and as output data zeros are transmitted.
 - The IO controller further receives the input data of the IO devices and transfers them cyclically to the input area of the CPU.
 - Behavior at CPU RUN
 - The IO controller cyclically reads the output data from the CPU and transfers these as telegram to the configured IO devices.
 - The IO controller receives the input data of the IO devices and transfers them cyclically to the input area of the CPU.

7.9 PROFINET diagnostics

7.9.1 Overview

There are the following possibilities to get diagnostics information from your system:

- Diagnostics with the configuration and engineering tool
- Diagnostics during runtime in the user program (OB 1, SFB 52)
- Diagnostics via OB start information
- Diagnostics status indication via SSLs

7.9.2 Diagnostics with the configuration and engineering tool

If you are connected from your configuration respectively engineering tool via Ethernet with the PROFINET IO controller, online diagnostics information may be accessed.

E.g. with 'Station → Open online' you get information about the state of your system. Here missing respectively faulty components are shown by symbols.

In the following figure e.g. there is shown that the configured device 3 is missing and device 4 reports an error.

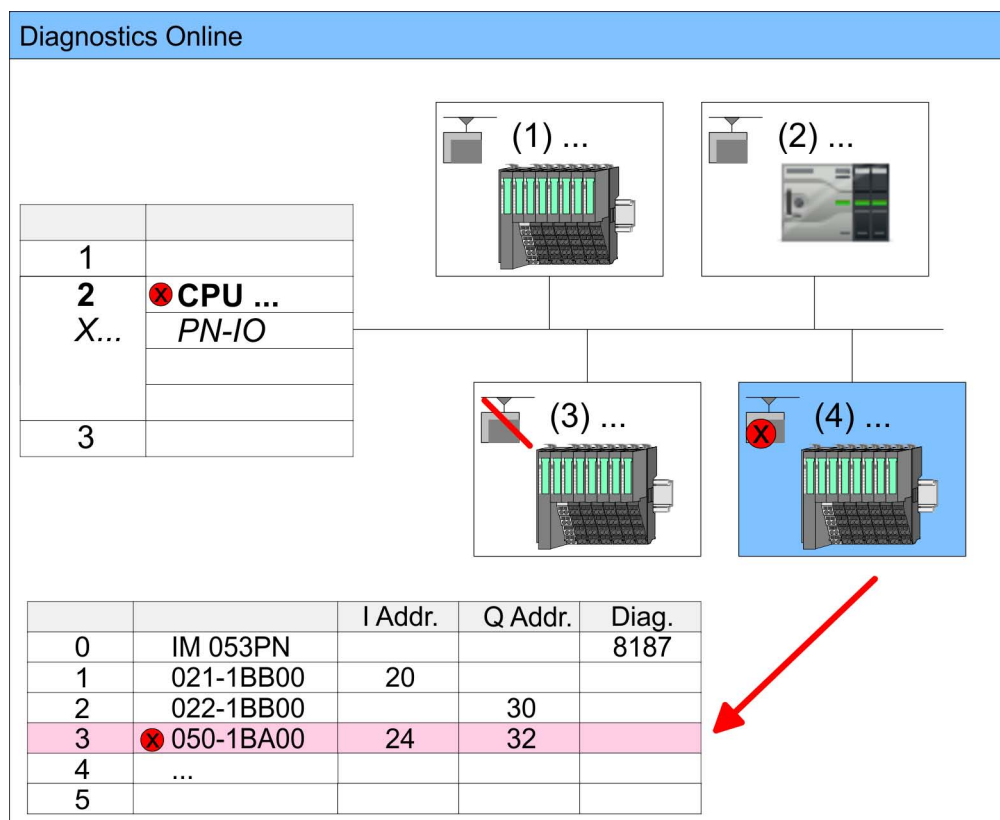

7.9.3 Diagnostics during runtime in the user program

With SFB 52 RDREC (read record) you can access diagnostics data from your user program e.g. in OB 1. The SFB 52 RDREC operates asynchronously, that is, processing covers multiple SFB calls.



More information about the usage of this block may be found in the manual "SPEED7 Operation List" from VIPA.

Example OB 1

For the cyclic access to the diagnostics data of the System SLIO counter module 050-1BA00 the following example may be used in the OB 1:

```

AN M10.3 'If the reading terminated (BUSY=0) and
AN M10.1 'there is no job triggered (REQ=0) then
S M10.1 'start transfer of record (REQ:=1)
L W#16#4000 'Number of record set (0x4000)
T MW12
CALL SFB 52, DB52 'Call SFB 52 with Instance DB
  REQ :=M10.1      'Trigger flag
  ID :=DW#16#0018 'Smaller addr. of mixed module
  INDEX :=MW12
  MLEN :=14       'Length record set 0x4000
                   'with 1 entry
  VALID :=M10.2   'Validity of the record set
  BUSY :=M10.3    'Flag job just running
  ERROR :=M10.4   'Error bit during read access
  STATUS :=MD14   'Error codes
  LEN :=MW16      'Length of the read record set
  RECORD :=P#M 100.0 Byte 40
                   'Target (MB100, 40byte)

U M10.1
R M10.1          'Reset REQ

```

Diagnostics data

The counter module 050-1BA00 serves for 20byte diagnostics data. The diagnostics data of the System SLIO module 050-1BA00 have the following structure:

Name:	Bytes	Function	Default
ERR_A	1	Diagnostics	00h
MODTYP	1	Module information	18h
ERR_C	1	reserved	00h
ERR_D	1	Diagnostics	00h
CHTYP	1	Channel type	76h
NUMBIT	1	Number diagnostics bits per channel	08h
NUMCH	1	Number channels of the module	01h
CHERR	1	Channel error	00h
CH0ERR	1	Channel-specific error	00h
CH1ERR...CH7ERR	7	reserved	00h
DIAG_US	4	µs ticker	00h



More information about the diagnostics data may be found in the System SLIO manual HB300_FM_050-1BA00.

7.9.4 Diagnostics via OB start information

- On an error the faulty system generates a diagnostics message for the CPU. Then the CPU calls the according diagnostics OB. Here the CPU operating system transfers start information to the local data of the OB.
- By evaluating the start information of the according OB you can get information about cause and location of the error.
- During runtime you can access the start information with the system function SFC 6 RD_SINFO.
- Please consider that you can even read the start information in the OB himself, because the data are temporary data.

Depending on the type of error, the following OBs are called in a diagnostics event:

- OB 82 on an error of an module at the IO device (Diagnostics interrupt)
- OB 83 on inserting respectively removing a module on a IO device
- OB 86 on failure respectively return of a IO device















More information about the OBs and their start information may be found in the online help of your programming tool and in the manual "SPEED7 Operation List" from VIPA.



7.9.5 Diagnostics status indication via SSLs

The PROFINET IO controller does not have any physical LEDs to show the status. The status information are stored as virtual LED states. During runtime, you can determine their status using the SSL partial lists xy19h or xy74h. More can be found in the manual operation list (HB00_OPL_SP7) of your CPU.

Virtual LEDs PROFINET

BF3 (bus error)	BS2 (Bus status)	MT2 (Maintenance)	Meaning
<input type="checkbox"/>	<input type="checkbox"/>	<input type="checkbox"/>	PROFINET is not configured.
<input type="checkbox"/>	<input checked="" type="checkbox"/>	<input type="checkbox"/>	PROFINET is configured with valid Ethernet interface parameter, valid IP address and at least one IO device.
<input checked="" type="checkbox"/>	X	X	<ul style="list-style-type: none"> ■ Bus error, no connection to sub net/switch. ■ Wrong transfer rate ■ Full-duplex-transmission is not activated.
<input checked="" type="checkbox"/> 2Hz	X	X	<ul style="list-style-type: none"> ■ Failure of a connected IO device. ■ At least one IO device is not access-able. ■ Faulty configuration ■ I device is configured, but no connection exists yet.

BF3 (bus error)	BS2 (Bus status)	MT2 (Maintenance)	Meaning
X	 1Hz	X	<ul style="list-style-type: none"> Ethernet interface parameter are not valid. I-Device is configured and <i>Link mode</i> does not correspond to '100 Mbps full duplex'.
X	 0.5Hz	X	There was no IP address assigned.
X	X		Maintenance event of an IO device is pending respectively an internal error happened.
 4s on, 1s off	X	 4s on, 1s off	Simultaneous blinking indicates a not valid configuration.
 4Hz		 4Hz	The alternate blinking indicates that a firmware update of the PROFINET IO controller is executed.
			Firmware update of the PROFINET IO controller is finished without error.
X	X	 2Hz	With a suited configuration tool you can cause the MT LED to blink by means of the function ' <i>Member blink test</i> '. This can be useful for e.g. identification of the module.

on:  | off:  | blinking:  | not relevant: X

Deployment BS LED - Bus status

- BS LED: off
 - PROFINET is not configured.
- BS LED: blinks with 1Hz
 - Ethernet interface parameter are not valid.
- BS LED: blinks with 0.5Hz
 - There was no IP address assigned.
- BS LED: on
 - PROFINET is configured with valid Ethernet interface parameter, valid IP address and at least one IO device.

Deployment of the MT LED - Maintenance

- MT LED: off
 - There is no maintenance event pending.
- MT LED: on
 - Maintenance event of an IO device is pending respectively an internal error happened.
 - Here in the diagnostic buffer of the CPU, an entry was created, where you can find more information about the maintenance event and to resolve it. ↪ *Chap. 4.19 'Diagnostic entries' page 105*
 - Resolve the error and execute PowerOFF/ON.
 - Currently you need to perform a power cycle, to switch the MT-LED off again.
- MT LED: blinks
 - With a suited configuration tool you can cause the LED to blink by means of the function '*Member blink test*'. This can be useful for e.g. identification of the module.
 - Simultaneous blinking together with BF2 LED (4s on, 1s off) indicates that the configuration is invalid.
 - The alternate blinking with BF2 LED with 4Hz indicates that a firmware update of the PROFINET IO controller is executed.

7.10 PROFINET system limits

Maximum number of devices and configurable connections

$$D = \sum_{i=1}^n \frac{1}{A_i}$$

Based on the devices, which have to communicate with the IO controller per ms, you can determine the maximum number of devices. This also results in the maximum number of configurable connections. The *Devices per ms* can be determined by the sum formula of the individual refresh times (A).

- D Devices per ms
- n Number of devices
- A Refresh time device



Please note that the value D must always be rounded to the nearest smaller integer!

The PROFINET IO controller has the following system limits

Devices per ms (D)	Max. number of devices	Max. number of configurable connections
3	8	0
2	8	2
1	8	2
0	8	2

Output bytes per ms

$$O = \sum_{i=1}^n \frac{B_i}{A_i}$$

- O Output bytes per ms
- n Number of devices
- B Number output bytes per device
- A Refresh time per device

The PROFINET IO controller has the following system limits:

- Max. Number output bytes per ms: 800
- Max. Number output bytes per device: 768

Input bytes per ms

$$I = \sum_{i=1}^n \frac{C_i}{A_i}$$

- I Input bytes per ms
- n Number of devices
- C Number input bytes per device
- A Refresh time per device

The PROFINET IO controller has the following system limits:

- Max. number input bytes per ms: 800
- Max. number input bytes per device: 768

8 Option: PtP communication

8.1 Fast introduction

General

For the PtP communication the use of the optionally available extension module EM M09 is required. The extension module provides interface X1: PtP (RS422/485) with fixed pin assignment. ↪ *Chap. 2.4 'Mounting' page 14*

- PtP functionality
 - Using the PtP functionality the interface is allowed to connect via serial point-to-point connection to different source res. target systems.

Protocols

The protocols respectively procedures ASCII, STX/ETX, 3964R, USS and Modbus are supported.

Parametrization

The parametrization of the serial interface happens during runtime using the FC/SFC 216 (SER_CFG). For this you have to store the parameters in a DB for all protocols except ASCII.

Communication

The FCs/SFCs are controlling the communication. Send takes place via FC/SFC 217 (SER_SND) and receive via FC/SFC 218 (SER_RCV). The repeated call of the FC/SFC 217 SER_SND delivers a return value for 3964R, USS and Modbus via RetVal that contains, among other things, recent information about the acknowledgement of the partner station. The protocols USS and Modbus allow to evaluate the receipt telegram by calling the FC/SFC 218 SER_RCV after SER_SND. The FCs/SFCs are included in the consignment of the CPU.



Use FCs instead SFCs

Please regard that the special VIPA SFCs are not shown in the CPU. Please use for programming tools e.g. Siemens SIMATIC Manager and TIA Portal the according FCs of the VIPA library.

Overview FCs/SFCs for serial communication

The following FCs/SFCs are used for the serial communication:

FC/SFC		Description
FC/SFC 216	SER_CFG	RS485 parameterize
FC/SFC 217	SER_SND	RS485 send
FC/SFC 218	SER_RCV	RS485 receive



More information about the usage of these blocks may be found in the manual "SPEED7 Operation List" from VIPA.

8.2 Principle of the data transfer

- RS485 PtP communication** The data transfer is handled during runtime by using FC/SFCs. The principle of data transfer is the same for all protocols and is shortly illustrated in the following.
- Data, which are written into the according data channel by the CPU, is stored in a FIFO send buffer (first in first out) with a size of 2x1024byte and then put out via the interface.
 - When the interface receives data, this is stored in a FIFO receive buffer with a size of 2x1024byte and can there be read by the CPU.
 - If the data is transferred via a protocol, the embedding of the data to the according protocol happens automatically.
 - In opposite to ASCII and STX/ETX, the protocols 3964R, USS and Modbus require the acknowledgement of the partner.
 - An additional call of the FC/SFC 217 SER_SND causes a return value in RetVal that includes among others recent information about the acknowledgement of the partner.
 - Further on for USS and Modbus after a SER_SND the acknowledgement telegram must be evaluated by a call of the FC/SFC 218 SER_RCV.

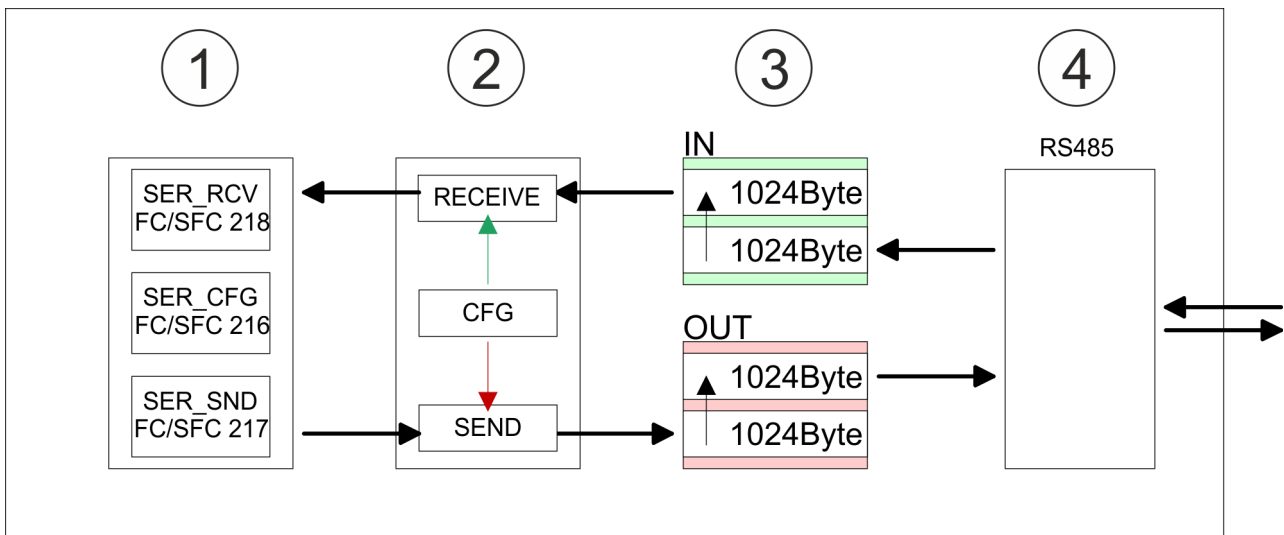

- 1 Program
- 2 Protocol
- 3 FIFO buffer
- 4 Interface

8.3 PtP communication via extension module EM M09

X1 PtP (RS422/485)



9pin SubD jack: (isolated)

Using the *PtP* functionality the RS485 interface is allowed to connect via serial point-to-point connection to different source res. target systems.

- Protocols:
 - ASCII
 - STX/ETX
 - 3964R
 - USS
 - Modbus master (ASCII, RTU)
- Serial bus connection
 - Full-duplex Four-wire operation (RS422)
 - Half-duplex Two-wire operation (RS485)
 - Data transfer rate: max 115 kBaud

Enable PtP functionality

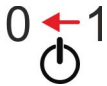

A hardware configuration to enable the PtP functionality is not necessary.

1. ➤ Turn off the power supply.

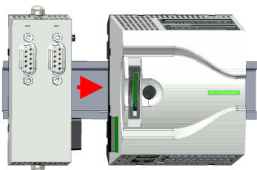

2. ➤ Mount the extension module. ↪ *Chap. 2.4 'Mounting' page 14*

3. ➤ Establish a cable connection to the communication partner.

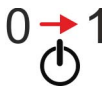

4. ➤ Switch on the power supply.

⇒ After a short boot time the interface X1 PtP is ready for PtP communication.

RS485 cabling with PROFIBUS cable

X1 PtP

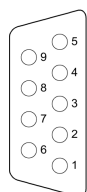

- ① n. c.
- ② TxD-P (line B) - RS422
- ③ RxD-P (line B) - RS422
RxD/TxD-P (line B) - RS485
- ④ RTS
- ⑤ M5V
- ⑥ P5V
- ⑦ TxD-N (line A) - RS422
- ⑧ RxD-N (line A) RS422
RxD/TxD-N (line A) - RS485
- ⑨ n.c.

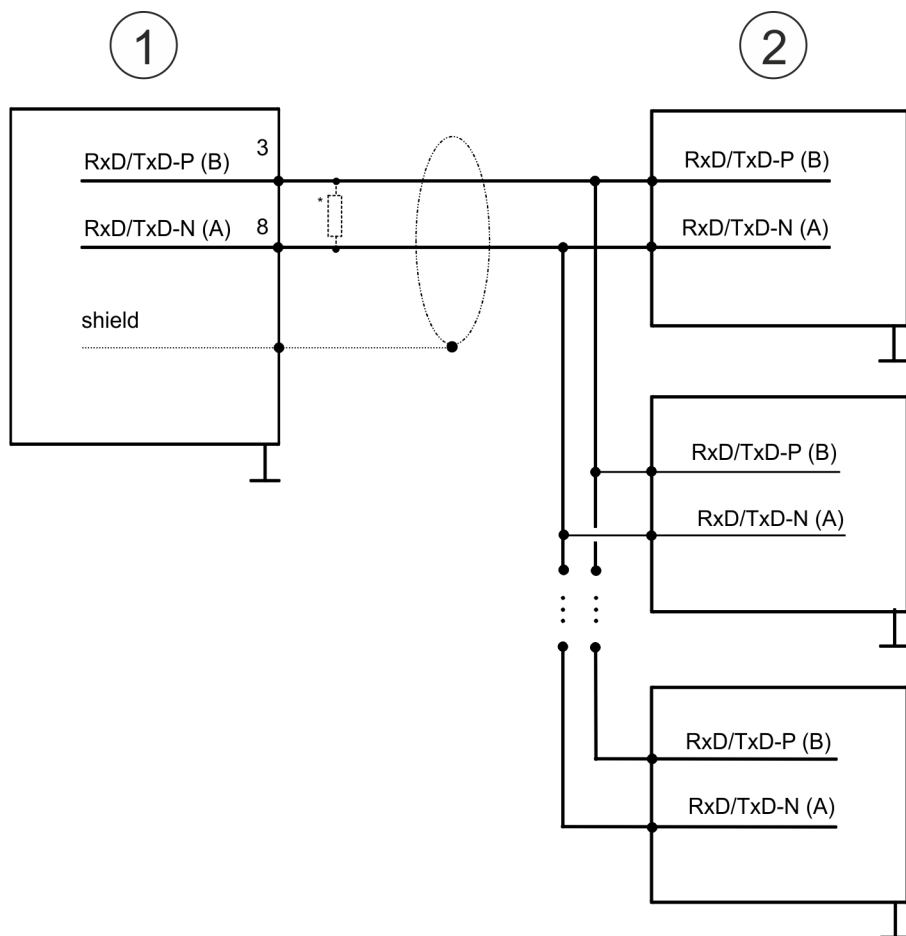

- 1 X1 PtP interface
- 2 Periphery



- *) For traffic-free data transfer use a terminating resistor of approximately 120Ω .
- Never connect the cable shield and the M5V (pin 5) together, due to the compensation currents the interfaces could be destroyed!

RS485 cabling with defined static voltage levels

For isolated interfaces you have 5V (P5V) isolated at pin 6 and the corresponding ground (M5V) at pin 5. With this isolated voltage, you can assign defined static voltage levels to the signal lines and so ensure a low reflection level.

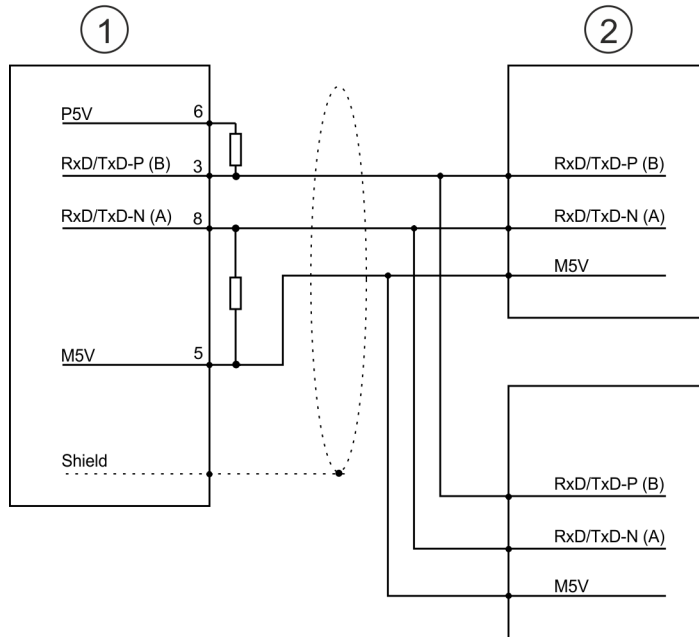
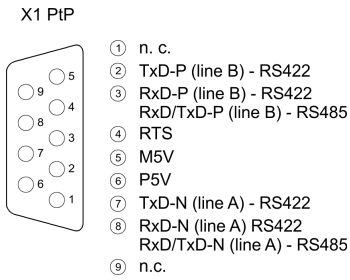

- 1 X1 PtP interface
- 2 Periphery

RS422 cabling

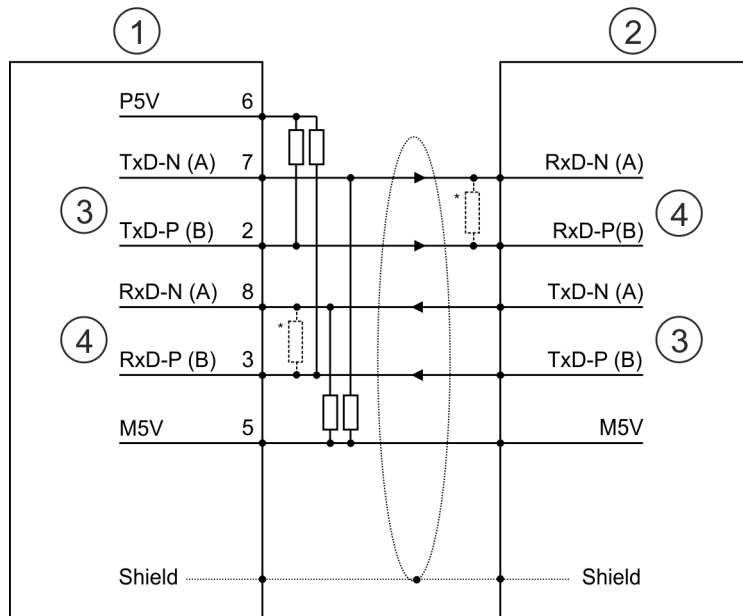
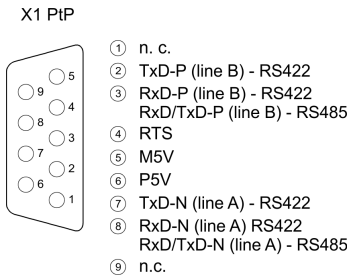

- 1 X1 PtP interface
- 2 Periphery
- 3 Send
- 4 Receive
- *) For line lengths >50m, you have to solder a terminating resistor of approx. 330Ω on the receiver side for traffic-free data transfer.

RS422 cabling with defined static voltage levels

For isolated interfaces you have 5V (P5V) isolated at pin 6 and the corresponding ground (M5V) at pin 5. With this isolated voltage, you can assign defined static voltage levels to the signal lines and so ensure a low reflection level.

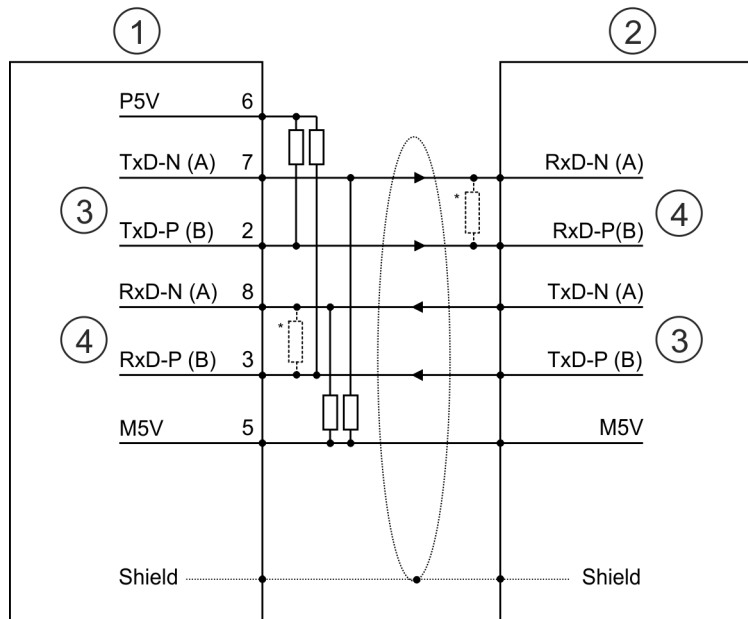
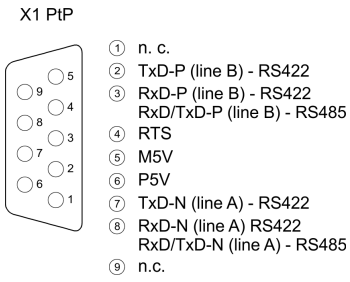

- 1 X1 PtP interface
- 2 Periphery
- 3 Send
- 4 Receive
- *) For line lengths >50m, you have to solder a terminating resistor of approx. 330Ω on the receiver side for traffic-free data transfer.

Status indication



X1 PtP	Description
TxD	
<input checked="" type="checkbox"/> green flickers	Send activity
<input type="checkbox"/>	No send activity

8.4 Parametrization

8.4.1 FC/SFC 216 - SER_CFG - Parametrization PtP

The parametrization happens during runtime deploying the FC/SFC 216 (SER_CFG). You have to store the parameters for STX/ETX, 3964R, USS and Modbus in a DB.

8.5 Communication

8.5.1 FC/SFC 217 - SER_SND - Send to PtP

This block sends data via the serial interface. The repeated call of the FC/SFC 217 SER_SND delivers a return value for 3964R, USS and Modbus via RETVAL that contains, among other things, recent information about the acknowledgement of the partner station. The protocols USS and Modbus require to evaluate the receipt telegram by calling the FC/SFC 218 SER_RCV after SER_SND.

8.5.2 FC/SFC 218 - SER_RCV - Receive from PtP

This block receives data via the serial interface. Using the FC/SFC 218 SER_RCV after SER_SND with the protocols USS and Modbus the acknowledgement telegram can be read.



More information about the usage of these blocks may be found in the manual "SPEED7 Operation List" from VIPA.

8.6 Protocols and procedures

Overview

The CPU supports the following protocols and procedures:

- ASCII communication
- STX/ETX
- 3964R
- USS
- Modbus

ASCII

ASCII data communication is one of the simple forms of data exchange. Incoming characters are transferred 1 to 1. At ASCII, with every cycle the read FC/SFC is used to store the data that is in the buffer at request time in a parametrized receive data block. If a telegram is spread over various cycles, the data is overwritten. There is no reception acknowledgement. The communication procedure has to be controlled by the concerning user application. For this you can use the FB 1 - Receive_ASCII.



More information about the usage of this block may be found in the manual "SPEED7 Operation List" from VIPA.

STX/ETX

STX/ETX is a simple protocol with start and end ID, where STX stands for **Start of Text** and ETX for **End of Text**.

- Any data transferred from the periphery must be preceded by a Start followed by the data characters and the end character. Depending of the byte width the following ASCII characters can be transferred: 5bit: not allowed; 6bit: 20...3Fh, 7bit: 20...7Fh, 8bit: 20...FFh.
- The effective data, which includes all the characters between Start and End are transferred to the CPU when the End has been received.

- When data is send from the CPU to a peripheral device, any user data is handed to the FC/SFC 217 (SER_SND) and is transferred with added Start- and End-ID to the communication partner.
- You may work with 1, 2 or no Start- and with 1, 2 or no End-ID.
- If no End-ID is defined, all read characters are transferred to the CPU after a parameterizable character delay time (Timeout).

As Start-res. End-ID all Hex values from 01h to 1Fh are permissible. Characters above 1Fh are ignored. In the user data, characters below 20h are not allowed and may cause errors. The number of Start- and End-IDs may be different (1 Start, 2 End res. 2 Start, 1 End or other combinations). For not used start and end characters you have to enter FFh in the hardware configuration.

Message structure:

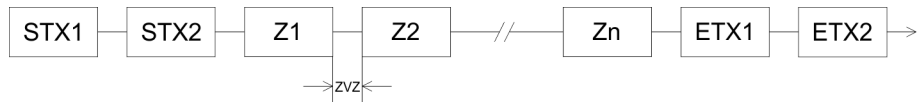

3964

The 3964R procedure controls the data transfer of a point-to-point link between the CPU and a communication partner. The procedure adds control characters to the message data during data transfer. These control characters may be used by the communication partner to verify the complete and error free receipt.

The procedure employs the following control characters:

- STX: **S**tart of **T**ext
- DLE: **D**ata **L**ink **E**scape
- ETX: **E**nd of **T**ext
- BCC: **B**lock **C**heck **C**haracter
- NAK: **N**egative **A**cknowledge

You may transfer a maximum of 255byte per message.

Procedure

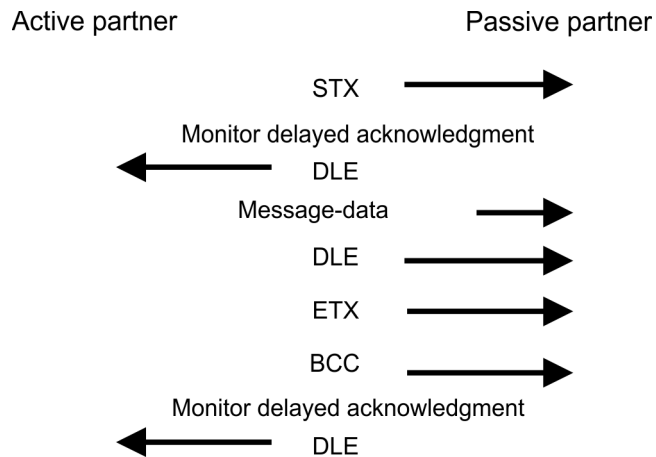

When a DLE is transferred as part of the information it is repeated to distinguish between data characters and DLE control characters that are used to establish and to terminate the connection (DLE duplication). The DLE duplication is reversed in the receiving station.

The 3964R procedure requires that a lower priority is assigned to the communication partner. When communication partners issue simultaneous send commands, the station with the lower priority will delay its send command.

USS

The USS protocol (**U**niverselle **s**erielle **S**chnittstelle = universal serial interface) is a serial transfer protocol defined by Siemens for the drive and system components. This allows to build-up a serial bus connection between a superordinated master and several slave systems. The USS protocol enables a time cyclic telegram traffic by presetting a fix telegram length.

The following features characterize the USS protocol:

- Multi point connection
- Master slave access procedure
- Single master system
- Max. 32 participants
- Simple and secure telegram frame

It is essential:

- You may connect 1 master and max. 31 slaves at the bus
- The single slaves are addressed by the master via an address sign in the telegram.
- The communication happens exclusively in half-duplex operation.
- After a send command, the acknowledgement telegram must be read by a call of the FC/SFC 218 SER_RCV.

The telegrams for send and receive have the following structure:

Master slave telegram

STX	LGE	ADR	PKE		IND		PWE		STW		HSW		BCC
02h			H	L	H	L	H	L	H	L	H	L	

Slave master telegram

STX	LGE	ADR	PKE		IND		PWE		ZSW		HIW		BCC
02h			H	L	H	L	H	L	H	L	H	L	

with

- STX - Start sign
- STW - Control word
- LGE - Telegram length
- ZSW - State word
- ADR - Address
- HSW - Main set value
- PKE - Parameter ID
- HIW - Main effective value
- IND - Index
- BCC - Block Check Character
- PWE - Parameter value

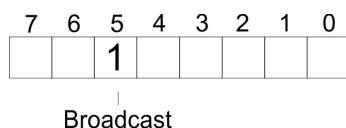
Broadcast with set bit 5 in ADR byte

A request can be directed to a certain slave or be sent to all slaves as broadcast message. For the identification of a broadcast message you have to set bit 5 to 1 in the ADR byte. Here the slave addr. (bit 0 ... 4) is ignored. In opposite to a "normal" send command, the broadcast does not require a telegram evaluation via FC/SFC 218 SER_RCV. Only write commands may be sent as broadcast.

Modbus

- The Modbus protocol is a communication protocol that fixes a hierarchic structure with one master and several slaves.
- Physically, Modbus works with a serial half-duplex connection. There are no bus conflicts occurring, because the master can only communicate with one slave at a time.
- After a request from the master, this waits for a preset delay time for an answer of the slave. During the delay time, communication with other slaves is not possible.
- After a send command, the acknowledgement telegram must be read by a call of the FC/SFC 218 SER_RCV.
- The request telegrams send by the master and the respond telegrams of a slave have the following structure:

Telegram structure

Start sign	Slave address	Function Code	Data	Flow control	End sign
------------	---------------	---------------	------	--------------	----------

Broadcast with slave address = 0

- A request can be directed to a special slave or at all slaves as broadcast message.
- To mark a broadcast message, the slave address 0 is used.
- In opposite to a "normal" send command, the broadcast does not require a telegram evaluation via FC/SFC 218 SER_RCV.
- Only write commands may be sent as broadcast.

ASCII, RTU mode

Modbus offers 2 different transfer modes. The mode selection happens during runtime by using the FC/SFC 216 SER_CFG.

- ASCII mode: Every byte is transferred in the 2 sign ASCII code. The data are marked with a start and an end sign. This causes a transparent but slow transfer.
- RTU mode: Every byte is transferred as one character. This enables a higher data pass through as the ASCII mode. Instead of start and end sign, a time control is used.

Supported Modbus protocols

The following Modbus Protocols are supported by the RS485 interface:

- Modbus RTU Master
- Modbus ASCII Master

8.7 Modbus - Function codes

Naming convention

Modbus has some naming conventions:

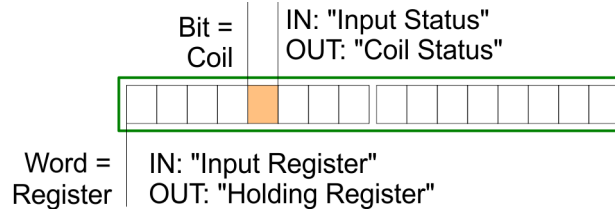

- Modbus differentiates between bit and word access; bits = "Coils" and words = "Register".
- Bit inputs are referred to as "Input-Status" and bit outputs as "Coil-Status".
- word inputs are referred to as "Input-Register" and word outputs as "Holding-Register".

Range definitions

Normally the access at Modbus happens by means of the ranges 0x, 1x, 3x and 4x.

0x and 1x gives you access to digital bit areas and 3x and 4x to analog word areas.

For the CPs from VIPA is not differentiating digital and analog data, the following assignment is valid:

- 0x - Bit area for master output data
Access via function code 01h, 05h, 0Fh
- 1x - Bit area for master input data
Access via function code 02h
- 3x - word area for master input data
Access via function code 04h
- 4x - word area for master output data
Access via function code 03h, 06h, 10h

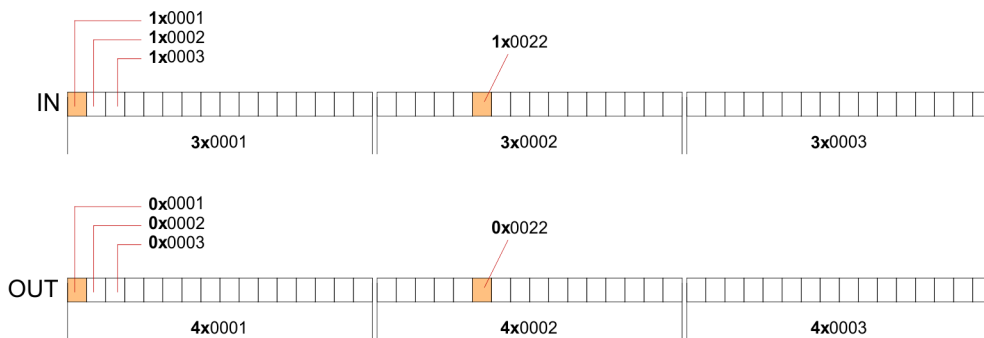

A description of the function codes follows below.

Overview

With the following Modbus function codes a Modbus master can access a Modbus slave:
With the following Modbus function codes a Modbus master can access a Modbus slave.
The description always takes place from the point of view of the master:

Code	Command	Description
01h	Read n bits	Read n bits of master output area 0x
02h	Read n bits	Read n bits of master input area 1x
03h	Read n words	Read n words of master output area 4x
04h	Read n words	Read n words master input area 3x
05h	Write 1 bit	Write 1 bit to master output area 0x
06h	Write 1 word	Write 1 word to master output area 4x
0Fh	Write n bits	Write n bits to master output area 0x
10h	Write n words	Write n words to master output area 4x

Point of View of "Input" and "Output" data

The description always takes place from the point of view of the master. Here data, which were sent from master to slave, up to their target are designated as "output" data (OUT) and contrary slave data received by the master were designated as "input" data (IN).

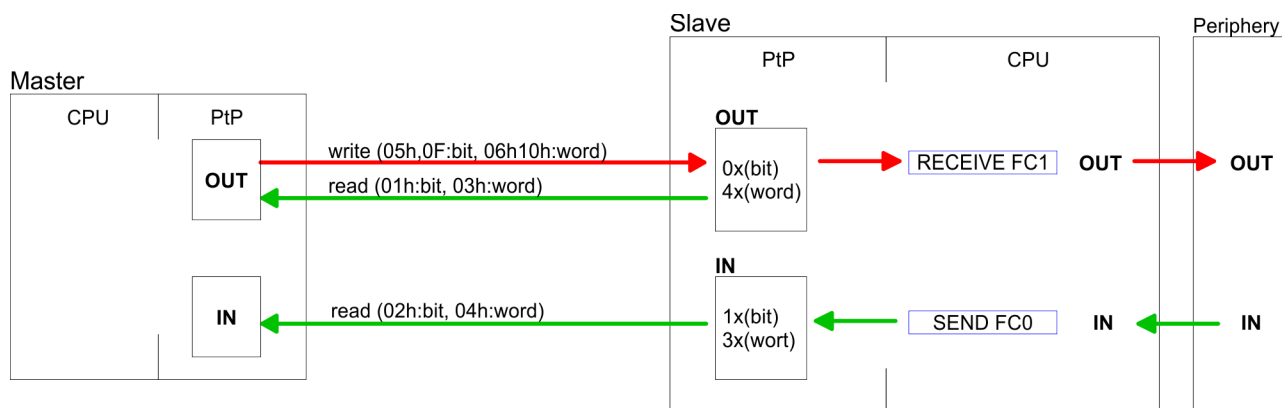

Respond of the slave

If the slave announces an error, the function code is send back with an "ORed" 80h. Without an error, the function code is sent back.

Slave answer:	Function code OR 80h	→ Error
	Function code	→ OK

Byte sequence in a word

1 word	
High-byte	Low-byte

Check sum CRC, RTU, LRC

The shown check sums CRC at RTU and LRC at ASCII mode are automatically added to every telegram. They are not shown in the data block.

Read n bits 01h, 02h

Code 01h: Read n bits of master output area 0x
 Code 02h: Read n bits of master input area 1x

Modbus - Function codes

Command telegram

Slave address	Function code	Address 1. bit	Number of bits	Check sum CRC/LRC
1byte	1byte	1word	1word	1word

Respond telegram

Slave address	Function code	Number of read bytes	Data 1. byte	Data 2. byte	...	Check sum CRC/LRC
1byte	1byte	1byte	1byte	1byte		1word
			max. 250byte			

Read n words 03h, 04h

03h: Read n words of master output area 4x

04h: Read n words master input area 3x

Command telegram

Slave address	Function code	Address 1. bit	Number of words	Check sum CRC/LRC
1byte	1byte	1word	1word	1word

Respond telegram

Slave address	Function code	Number of read bytes	Data 1. word	Data 2. word	...	Check sum CRC/LRC
1byte	1byte	1byte	1word	1word		1word
			max. 125words			

Write 1 bit 05h

Code 05h: Write 1 bit to master output area 0x

A status change is via "Status bit" with following values:

"Status bit" = 0000h → Bit = 0

"Status bit" = FF00h → Bit = 1

Command telegram

Slave address	Function code	Address bit	Status bit	Check sum CRC/LRC
1byte	1byte	1word	1word	1word

Respond telegram

Slave address	Function code	Address bit	Status bit	Check sum CRC/LRC
1byte	1byte	1word	1word	1word

Write 1 word 06h

Code 06h: Write 1 word to master output area 4x

Command telegram

Slave address	Function code	Address word	Value word	Check sum CRC/LRC
1byte	1byte	1word	1word	1word

Respond telegram

Slave address	Function code	Address word	Value word	Check sum CRC/LRC
1byte	1byte	1word	1word	1word

Write n bits 0Fh

Code 0Fh: Write n bits to master output area 0x

Please regard that the number of bits has additionally to be set in byte.

Command telegram

Slave address	Function code	Address 1. bit	Number of bits	Number of bytes	Data 1. byte	Data 2. byte	...	Check sum CRC/LRC
1byte	1byte	1word	1word	1byte	1byte	1byte	1byte	1word
					max. 250byte			

Respond telegram

Slave address	Function code	Address 1. bit	Number of bits	Check sum CRC/LRC
1byte	1byte	1word	1word	1word

Write n words 10h

Code 10h: Write n words to master output area 4x

Command telegram

Slave address	Function code	Address 1. word	Number of words	Number of bytes	Data 1. word	Data 2. word	...	Check sum CRC/LRC
1byte	1byte	1word	1word	1byte	1word	1word	1word	1word
					max. 125words			

Respond telegram

Slave address	Function code	Address 1. word	Number of words	Check sum CRC/LRC
1byte	1byte	1word	1word	1word

9 Option: Deployment PROFIBUS communication

9.1 Fast introduction

Overview

For the PROFIBUS communication the use of the optionally available extension module EM M09 is required. The extension module provides interface X2: MPI(PB) with fixed pin assignment. ↗ *Chap. 2.4 'Mounting' page 14* The PROFIBUS DP slave is to be configured in the hardware configurator from Siemens. Here the configuration happens by the sub module X1 (MPI/DP) of the Siemens CPU.



*To switch the interface X2 MPI(PB) to PROFIBUS functionality you have to activate the according bus functionality by means of a VSC storage media from VIPA. By plugging the VSC storage card and then an overall reset the according functionality is activated. ↗ *Chap. 4.15 'Deployment storage media - VSD, VSC' page 98**

Steps of configuration

The configuration of the PROFIBUS DP slave should be done with the following approach:

- **Activating bus functionality by means of a VSC**
- **Hardware configuration - CPU**
- **Use as DP slave**
 - With activating the bus functionality 'PROFIBUS DP slave' by means of a VSC, the bus functionality 'PROFIBUS DP slave' is unlocked.
- **Transfer of the entire project to the CPU**



With the Siemens SIMATIC Manager, the CPU M13-CCF0000 from VIPA is to be configured as

CPU 314C-2 PN/DP (314-6EH04-0AB0 V3.3)

The PROFIBUS DP slave is to be configured and connected via the sub module X1 (MPI/DP).

9.2 PROFIBUS communication

PROFIBUS DP

- PROFIBUS is an international standard applicable to an open and serial field bus for building, manufacturing and process automation that can be used to create a low (sensor-/actuator level) or medium (process level) performance network of programmable logic controllers.
- PROFIBUS comprises an assortment of compatible versions. The following details refer to PROFIBUS DP.
- PROFIBUS DP is a special protocol intended mainly for automation tasks in a manufacturing environment. DP is very fast, offers Plug'n'Play facilities and provides a cost-effective alternative to parallel cabling between PLC and remote I/O. PROFIBUS DP was designed for high-speed data communication on the sensor-actuator level.
- The data transfer referred to as "Data Exchange" is cyclical. During one bus cycle, the master reads input values from the slaves and writes output information to the slaves.

DP slave operation

For the deployment in a super-ordinated master system you first have to project your slave system as Siemens CPU in slave operation mode with configured in-/output areas. Afterwards you configure your master system. Couple your slave system to your master system by dragging the CPU 31x from the hardware catalog at *Configured stations* onto the master system, choose your slave system and connect it.

Operating mode DP slave: Test, commissioning, routing (active/passive)

There is the possibility to enable the option '*Test, commissioning, routing*' in the hardware configuration by means of the properties dialog of the PROFIBUS via the register '*Operating mode*' at '*DP slave*'. The activation affects as follows:

- The PROFIBUS interface gets an "active" PROFIBUS node, this means it is involved in the token rotation.
- Via this interface you have PG/OP functions (programming, status request, control, test).
- The PROFIBUS interface serves as a gateway (S7 routing).
- The bus rotation time can exceed.

When disabled, the PROFIBUS interface operates as passive DP slave with the following characteristics:

- The PROFIBUS interface gets an "passive" PROFIBUS node, this means it is not involved in the token rotation.
- Bus rotation time is not influenced.
- S7 routing is not possible.

9.3 PROFIBUS communication via extension module EM M09

X2 MPI(PB)



9pin SubD jack: (isolated)

The interface supports the following functionalities, which are switch able by an hardware configuration:

- MPI (default / after overall reset)
The MPI interface serves for the connection between programming unit and CPU. By means of this the project engineering and programming happens. In addition MPI serves for communication between several CPUs or between HMIs and CPU. Standard setting is MPI address 2.
- PROFIBUS DP slave (option)
The PROFIBUS slave functionality of this interface can be activated by configuring the sub module 'MPI/DP' of the CPU in the hardware configuration.

Enable PROFIBUS functionality

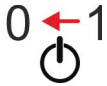

The activation of the PROFIBUS functionality of the extension module EM M09 happens with the following proceeding:

1. ➔ Turn off the power supply.

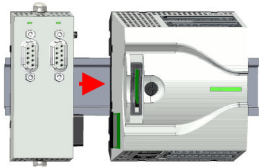

2. ➔ Mount the extension module. ↪ *Chap. 2.4 'Mounting' page 14*

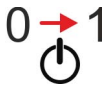

3. ➔ Switch on the power supply.

⇒ After a short boot time the interface X2 MPI(PB) is ready for MPI communication with the MPI address 2.



To switch the interface X2 MPI(PB) to PROFIBUS functionality you have to activate the according bus functionality by means of a VSC storage media from VIPA. By plugging the VSC storage card and then an overall reset the according functionality is activated. ↪ *Chap. 4.15 'Deployment storage media - VSD, VSC' page 98*

X2 MPI(PB)

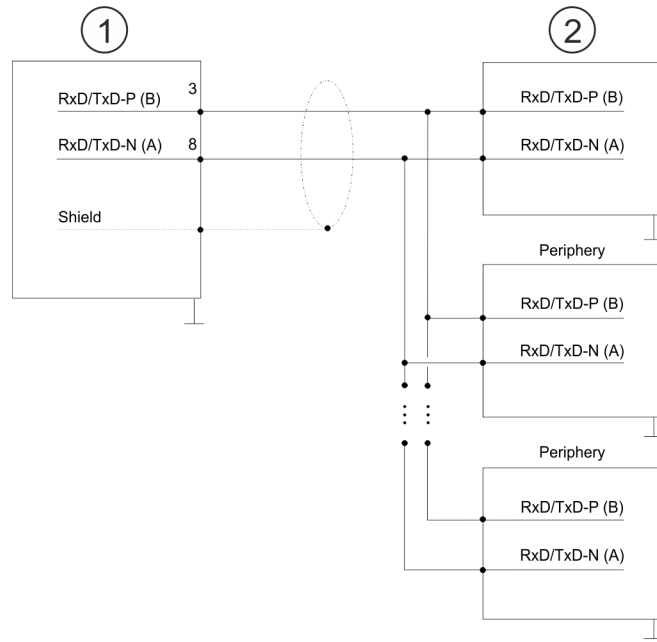
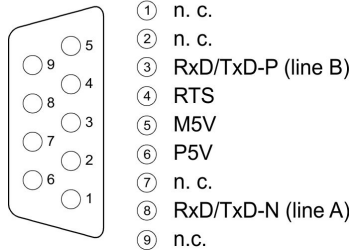

- 1 RS485 interface
- 2 Periphery



Never connect the cable shield and the M5V (pin 5) together, since the interfaces could be destroyed!

Status indication



X2 MPI(PB) DE	Description
<input checked="" type="checkbox"/> green	<ul style="list-style-type: none"> ■ Slave is in DE (data exchange). ■ Slave exchanges data with the master. ■ Slave is in RUN state
<input checked="" type="checkbox"/> green blinking	<ul style="list-style-type: none"> ■ Slave CPU is in state start-up. ■ Slave-CPU is without master.
<input type="checkbox"/>	<ul style="list-style-type: none"> ■ There is no power supply. ■ Slave has no configuration.

9.4 Deployment as PROFIBUS DP slave

Fast introduction

In the following the deployment of the PROFIBUS section as "intelligent" DP slave on master system is described, which exclusively may be configured in the Siemens SIMATIC Manager. The following steps are required:

1. ➤ Configure a station with a CPU with operating mode DP slave.
2. ➤ Connect to PROFIBUS and configure the in-/output area for the slave section.
3. ➤ Save and compile your project.
4. ➤ Configure another station with another CPU with operating mode DP master.
5. ➤ Connect to PROFIBUS and configure the in-/output ranges for the master section.
6. ➤ Save, compile and transfer your project to your CPU.

Project engineering of the slave section

1. ➤ Start the Siemens SIMATIC Manager and configure a CPU as described at "Hardware configuration - CPU".
2. ➤ Designate the station as "...DP slave".
3. ➤ Add your modules according to the real hardware assembly.
4. ➤ Open the properties dialog of the DP interface of the CPU by means of a double-click at 'MPI/DP'.
5. ➤ Set Interface type to "PROFIBUS".
6. ➤ Connect to PROFIBUS and preset an address (e.g. 3) and confirm with [OK].
7. ➤ Switch at Operating mode to "DP slave" .
8. ➤ Via Configuration you define the in-/output address area of the slave CPU, which are to be assigned to the DP slave.
9. ➤ Save, compile and transfer your project to your CPU.

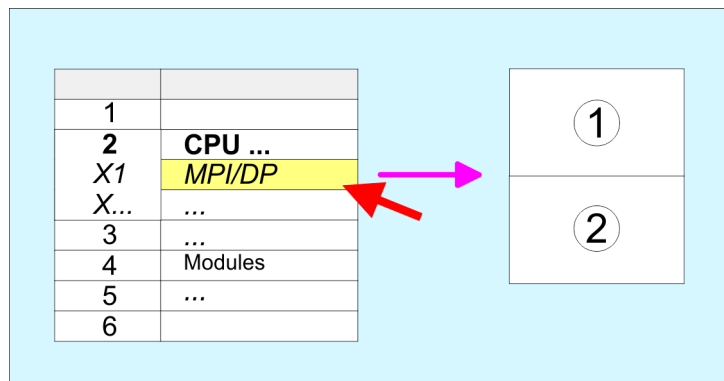

- 1 Standard bus: Object properties
Operating mode: DP slave
Connect: PROFIBUS
PROFIBUS address > 1
- 2 Configuration
Input area
Output area

Project engineering of the master section

1. ➤ Insert another station and configure a CPU.
2. ➤ Designate the station as "...DP master".
3. ➤ Add your modules according to the real hardware assembly.

4. ➤ Open the properties dialog of the DP interface of the CPU by means of a double-click at 'MPI/DP'.
5. ➤ Set Interface: type to "PROFIBUS".
6. ➤ Connect to PROFIBUS and preset an address (e.g. 2) and confirm with [OK].
7. ➤ Switch at Operating mode to "DP master" and confirm the dialog with [OK].
8. ➤ Connect your slave system to this master system by dragging the "CPU 31x" from the hardware catalog at *Configured stations* onto the master system and select your slave system to be coupled.
9. ➤ Open the *Configuration at Object properties* of your slave system.
10. ➤ Via double click to the according configuration line you assign the according input address area on the master CPU to the slave output data and the output address area to the slave input data.
11. ➤ Save, compile and transfer your project to your CPU.

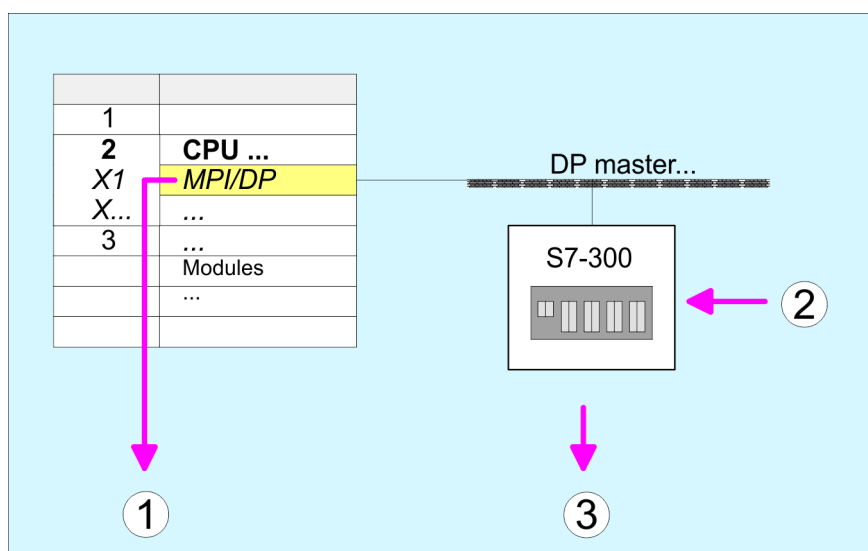

- 1 Standard bus: Object properties
Operating mode: DP master
PROFIBUS address > 1
- 2 Hardware catalog: CPU 31x

- 3 DP master system: Object properties
Input area slave CPU = Output area master CPU
Output area slave CPU = Input area master CPU

9.5 PROFIBUS installation guidelines

PROFIBUS in general

- A PROFIBUS DP network may only be built up in linear structure.
- PROFIBUS DP consists of minimum one segment with at least one master and one slave.
- A master has always been deployed together with a CPU.
- PROFIBUS supports max. 126 participants.
- Per segment a max. of 32 participants is permitted.
- The max. segment length depends on the transfer rate:
 - 9.6 ... 187.5bit/s → 1000m
 - 500kbit/s → 400m
 - 1.5Mbit/s → 200m
 - 3 ... 12Mbit/s → 100m
- Max. 10 segments may be built up. The segments are connected via repeaters. Every repeater counts for one participant.
- The bus respectively a segment is to be terminated at both ends.
- All participants are communicating with the same transfer rate. The slaves adjust themselves automatically on the transfer rate.

Transfer medium

- As transfer medium PROFIBUS uses an isolated twisted-pair cable based upon the RS485 interface.
- The RS485 interface is working with voltage differences. Though it is less irritable from influences than a voltage or a current interface. You are able to configure the network as well linear as in a tree structure.
- Max. 32 participants per segment are permitted. Within a segment the members are linear connected. The segments are connected via repeaters. The maximum segment length depends on the transfer rate.
- PROFIBUS DP uses a transfer rate between 9.6kbit/s and 12Mbit/s, the slaves are following automatically. All participants are communicating with the same transfer rate.
- The bus structure under RS485 allows an easy connection res. disconnection of stations as well as starting the system step by step. Later expansions don't have any influence on stations that are already integrated. The system realizes automatically if one partner had a fail down or is new in the network.

Bus connection

The following picture illustrates the terminating resistors of the respective start and end station.

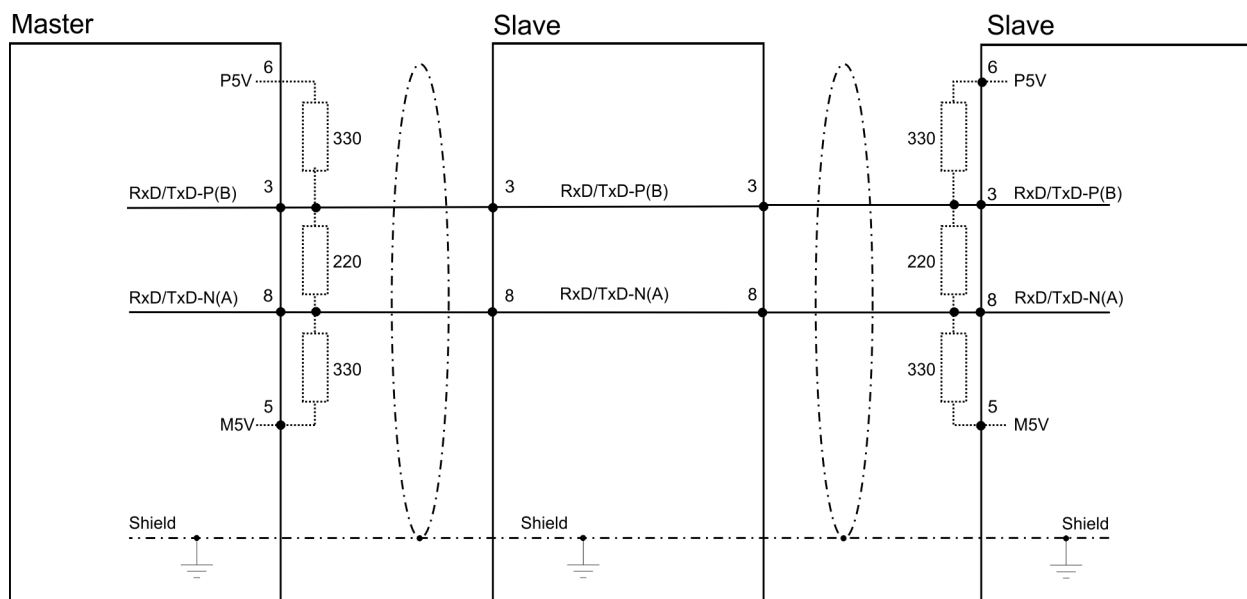



The PROFIBUS line has to be terminated with its ripple resistor. Please make sure to terminate the last participants on the bus at both ends by activating the terminating resistor.

EasyConn bus connector



In PROFIBUS all participants are wired parallel. For that purpose, the bus cable must be feed-through. Via the order number 972-0DP10 you may order the bus connector "EasyConn" from VIPA. This is a bus connector with switchable terminating resistor and integrated bus diagnostic.

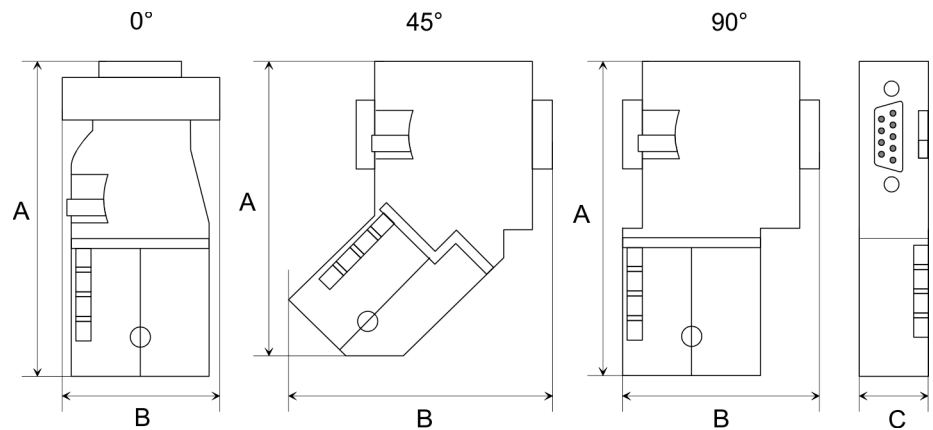

Dimensions in mm	0°	45°	90°
A	64	61	66
B	34	53	40
C	15.8	15.8	15.8



To connect this EasyConn plug, please use the standard PROFIBUS cable type A (EN50170). Starting with release 5 you also can use highly flexible bus cable:

Lapp cable order no: 2170222, 2170822, 2170322.

With the order no. 905-6AA00 VIPA offers the "EasyStrip" de-isolating tool that makes the connection of the EasyConn much easier.



Dimensions in mm

Termination with "EasyConn"

The "EasyConn" bus connector is provided with a switch that is used to activate a terminating resistor.

Wiring

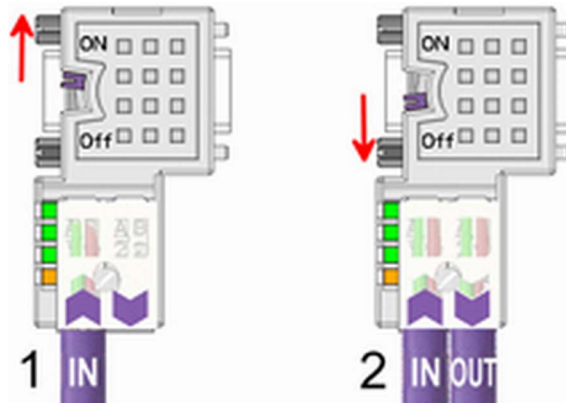

- [1] 1./last bus participant
- [2] further participants



CAUTION!

The terminating resistor is only effective, if the connector is installed at a bus participant and the bus participant is connected to a power supply.

The tightening torque of the screws to fix the connector to a device must not exceed 0.02Nm!



A complete description of installation and deployment of the terminating resistors is delivered with the connector.

Assembly

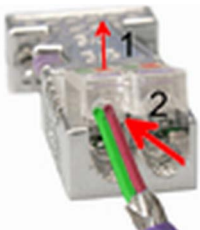

1. Loosen the screw.
2. Lift contact-cover.
3. Insert both wires into the ducts provided (watch for the correct line colour as below!)
4. Please take care not to cause a short circuit between screen and data lines!



5. Close the contact cover.
6. Tighten screw (max. tightening torque 0.08Nm).



The green line must be connected to A, the red line to B!

10 Configuration with VIPA *SPEED7 Studio*

10.1 *SPEED7 Studio* - Overview

SPEED7 Studio - Working environment

In this part the project engineering of the VIPA CPU in the VIPA *SPEED7 Studio* is shown. Here only the basic usage of the *SPEED7 Studio* together with a VIPA CPU is shown. Please note that software changes can not always be considered and it may thus be deviations to the description. In the *SPEED7 Studio* your VIPA PLCs may be configured and linked. For diagnostics online tools are available.



*More information can be found in the online help respectively in documentation of the *SPEED7 Studio*.*

Starting the *SPEED7 Studio*



- ➔ Click at the button. You can find *SPEED7 Studio* in Windows Start at 'VIPA'.
- ⇒ *SPEED7 Studio* is started. The *start page* is opened.

SPEED7 Studio

Project Folder	Source	Last Access
MyProject	local	10/29/2013 5:59:03 PM

- (1) Start You can create a new project, open a saved project, or delete projects.
- (2) Project If a project is open, you can open the 'Project overview' or add a new device.
- (3) Last projects Here recently opened projects are listed.



*You can repeatedly run *SPEED7 Studio* in order to work with different projects. You can not open the same project in the various instances of *SPEED7 Studio*.*

End SPEED7 Studio

- ➔ Select one of the following options if you want to end the program:
 - **Main window:** Click on the Close button of the *SPEED7 Studio* program window.
 - **Menu bar** Select '*File* ➔ *Exit*'.
 - **Keyboard:** Press [Alt] + [F4].

After you have made changes to the project, a dialogue window opens where you can select whether to save or ignore the changes.

⇒ *SPEED7 Studio* is ended.

10.2 SPEED7 Studio - Work environment

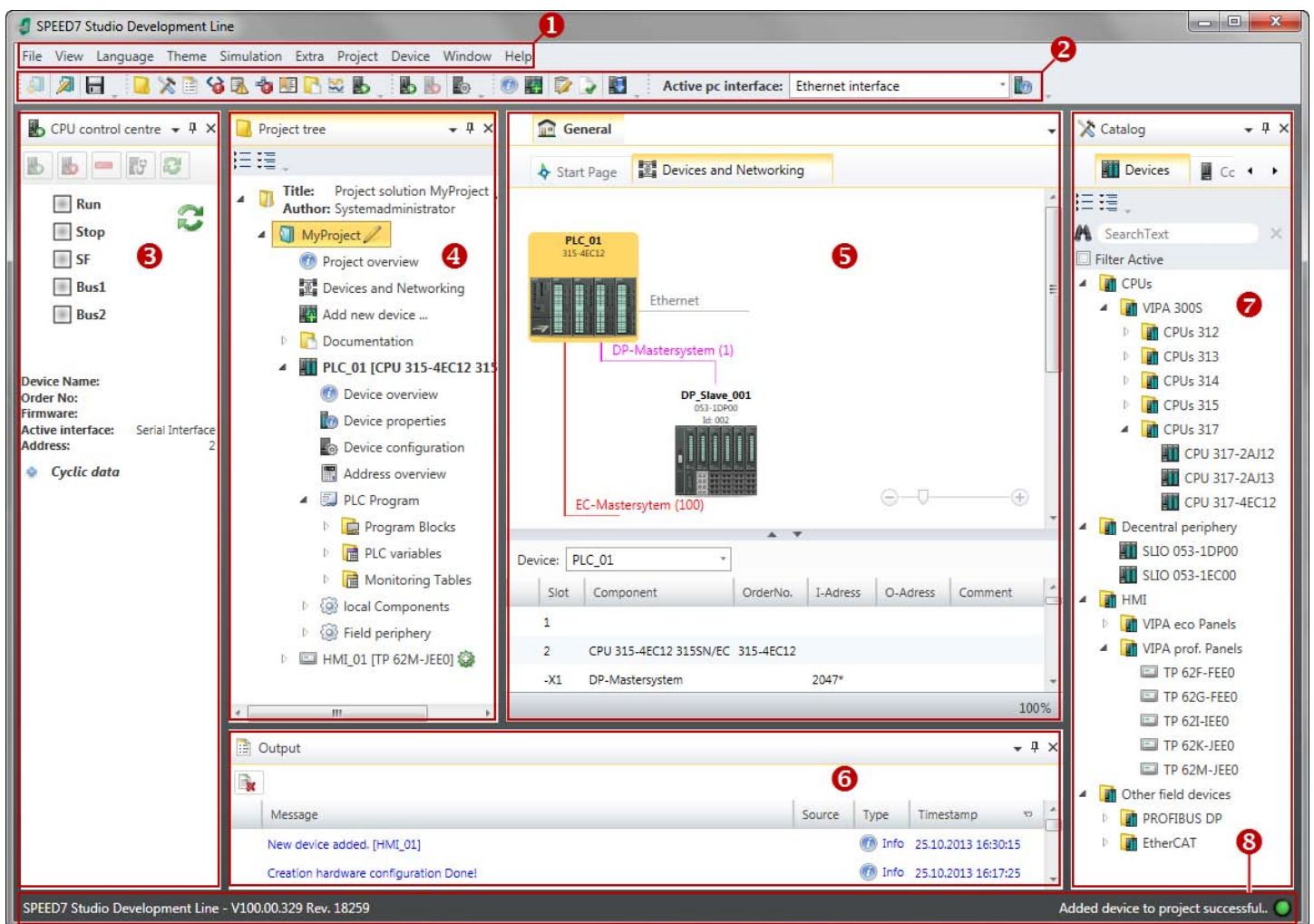

- (1) Menu bar
- (2) Toolbar
- (3) CPU control centre
- (4) Project tree
- (5) Area of operations
- (6) Output range
- (7) Catalog/properties
- (8) Status line

You can show and hide additional windows and the arrangement and size of the windows can be adjusted.

- (1) Menu bar**
- Most of the commands you need for working with *SPEED7 Studio* are provided in the menu bar. Further commands can be accessed via the context menus using the right mouse button, e.g. functions of a device in the project tree.
- The menu commands *'Project'* and *'Device'* are only shown if a project is open. The menu commands *'Image'* is only shown if a HMI image is open.
- You can use the menus with the mouse or the keyboard.
- (2) Toolbar**
- Important commands you need for working with *SPEED7 Studio* are provided in the toolbar. More commands can be accessed via the toolbars and push buttons of different editors.
- Some of the commands in the toolbar are only shown if a project is open.
- (3) CPU control centre**
- In the CPU control centre, you can view the current mode and other control data and control the CPU.
- (4) Project tree**
- Any project device and project data can be accessed via the project tree. The project tree includes any object which you have created in the project, e.g. devices, components, program blocks, HMI images. Here you can add or remove devices and components. Furthermore, you can open editors in order to edit settings, configurations, the control program and visualisation.
- (5) Area of operations**
- Devices and project data can be edited in the area of operations. You can open different editors for this purpose. The register in the area of operations is divided into two register levels. You can switch through the editors in the area of operations via the tabs.
- (6) Output range**
- Information on executed activities and background operations are displayed on the output range.
- (7) Catalog/properties**
- Devices and components which you want to add to the project can be selected in the catalog. You can also select objects which you want to add to the PLC program or to HMI images.
- (8) Status line**
- The version of *SPEED7 Studio* is displayed at the left edge of the status line. The progress bar for background operations and status messages is shown at the right edge. As long as there are no background operations, the status message created at last is shown.

10.2.1 Project tree

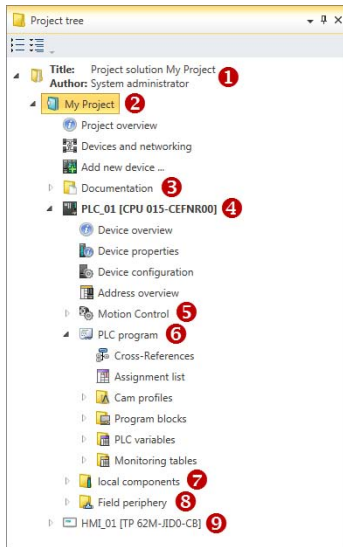

- (1) Title and author
- (2) Project
- (3) Documentation
- (4) PLC
- (5) Motion Control
- (6) PLC program
- (7) Local components
- (8) Field periphery
- (9) HMI

In the project tree, you can access commands in order to add or delete objects, e.g. add/delete devices or add/delete blocks.

You can open editors via the project tree if you want to edit settings, configurations, the control program and visualisation.

Moreover, you can retrieve information, e.g. project overview, device properties or properties of the bus system.

Show project tree

If the project tree is not displayed, you must select either 'View → Project tree' or press [Strg]+[Shift]+[P].





Show projects in the project tree

In order to display the project in the project tree, you must create a new project or open a stored project.

It is not possible to edit several projects at the same time. It is possible to run *SPEED7 Studio* simultaneously several times on one PC if you want to use it for various projects.

Show/hide objects

The objects in the project tree are arranged in a tree structure. You can show or hide objects:

-  Hide all objects ('Project → Reduce project tree')
-  Show all objects ('Project → Expand project tree')
-  Hide slave objects / close folder
-  Show slave objects / open folder

Recognise object state

Icons behind an object in the project tree provide indications of the object state.

10.2.2 Catalog

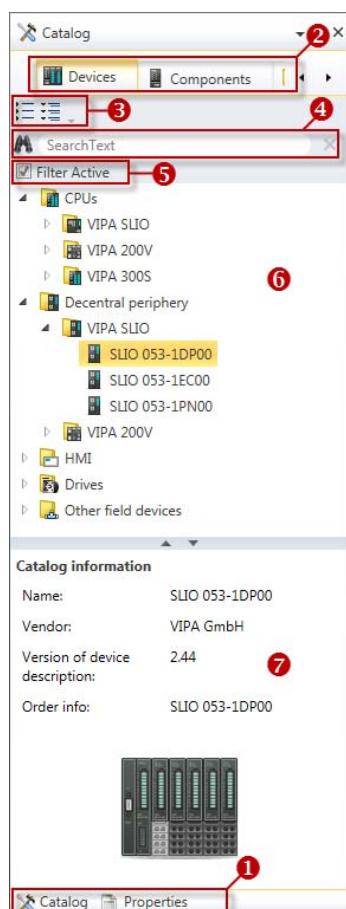

- (1) Switching to another view
- (2) Register
- (3) Show/hide objects
- (4) Search
- (5) Filter
- (6) Objects
- (7) Catalog information

Devices and components which you want to add to the project can be selected in the catalog. You can also select objects which you want to add to the PLC program or to HMI images.

Show catalog:

If the catalog is not displayed, you must select either 'View → Catalog' or press [Strg]+[Shift]+[C].

(1) Switch to another view

If the properties are displayed instead of the catalog, you must click on 'Catalog' at the lower screen edge.

(2) Register

Certain tabs are displayed in the catalog, depending on which editor window is opened in the foreground.

(3) Show/hide objects

The objects in the catalog are arranged in a tree structure. You can show or hide objects:

Hide all objects ('Project → Reduce project tree')

 Hide all objects ('Project → Reduce catalog tree')

 Show all objects ('Project → Expand catalog tree')

 Hide slave objects / close folder

 Show slave objects / open folder

(4) Search

You can search for certain objects in the catalog.

1. Enter a search text in the input field.
 - ⇒ Only those objects are displayed in the catalog which contain the search text.
2. Click on to delete the search text.
 - ⇒ All objects are displayed in the catalog.

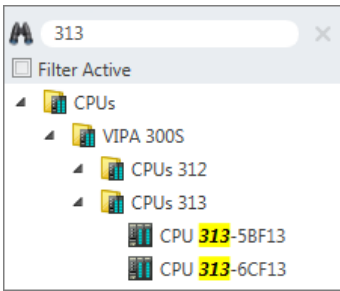

(5) Filter

With 'enabled' Filter, only these modules are shown in the *Catalog* which are relevant for configuration

(6) Add object

- ➔ Drag the desired object from the catalog to a suitable position.
 - ⇒ The object is added.

Example

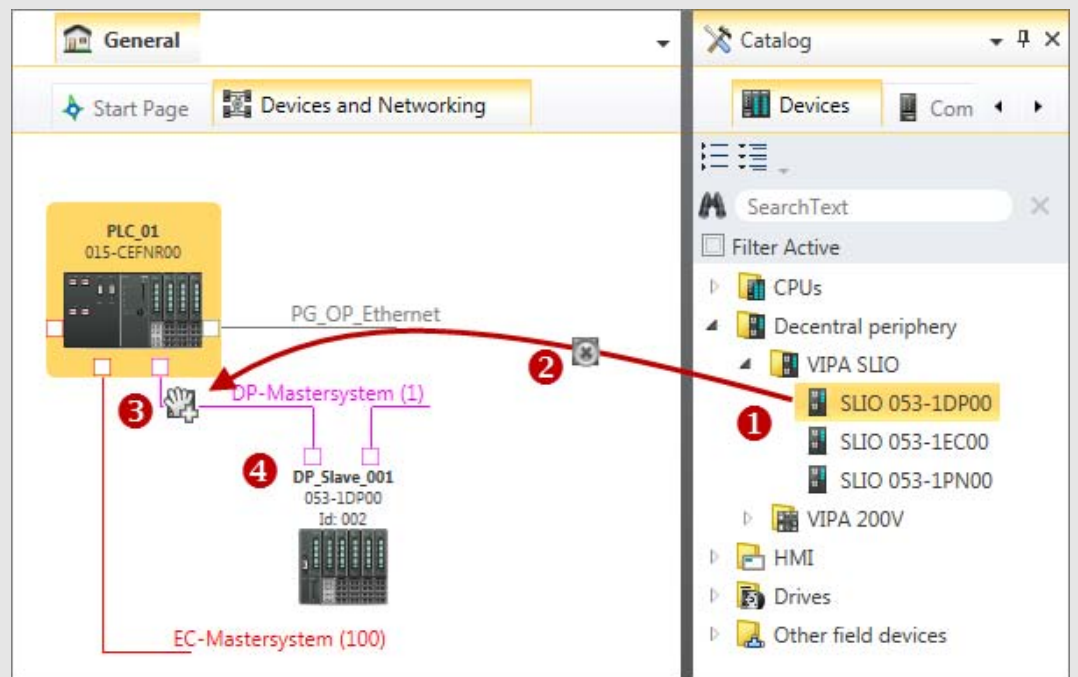

- (1) Select the desired object (hold left mouse button down)
- (2) Drag the object
- (3) Drop the object at a suitable place (release the mouse button)
- (4) The object is added

(7) Catalog information

The catalog information shows detailed information of the selected object, e.g. name, producer, version and order information.

10.3 SPEED7 Studio - Hardware configuration - CPU

Precondition

 For project engineering a thorough knowledge of the SPEED7 Studio is required!

Proceeding

1. Start the *SPEED7 Studio*.
2. Create a new project in the *Work area* with *'New project'*.
⇒ A new project is created and the view *'Devices and networking'* is shown.
3. Click in the *Project tree* at *'Add new device ...'*.
⇒ A dialog for device selection opens.
4. Select from the *'Device templates'* your CPU and click at [OK].
⇒ The CPU is inserted in *'Devices and networking'* and the *'Device configuration'* is opened.

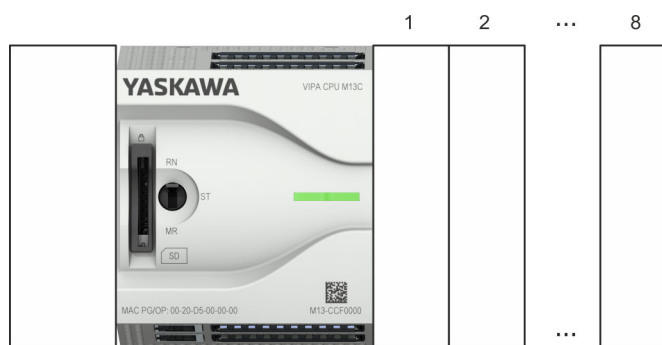
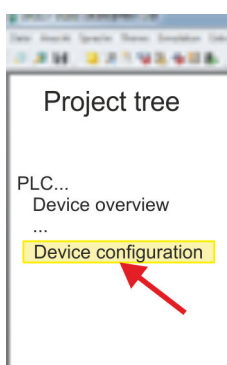

Device configuration

Slot	Module
0	CPU M13-CCF0000				
-X2	MPI interface				
-X3	PG_OP_Ethernet				
...	

10.4 *SPEED7 Studio* - Hardware configuration - Ethernet PG/OP channel

Overview

The CPU has an integrated Ethernet PG/OP channel. This channel allows you to program and remote control your CPU.

- The Ethernet PG/OP channel (X3/X4) is designed as switch. This enables PG/OP communication via the connections X3 and X4.
- Configurable connections are possible.
- DHCP respectively the assignment of the network configuration with a DHCP server is supported.
- Default diagnostics addresses: 2025 ... 2040
- At the first commissioning respectively after a factory reset the Ethernet PG/OP channel has no IP address. For online access to the CPU via the Ethernet PG/OP channel, valid IP address parameters have to be assigned to this by means of your configuration tool. This is called "initialization".
- Via the Ethernet PG/OP channel, you have access to:
 - Device website, where you can find information on firmware status, connected peripherals, current cycle times, etc.
 - *WebVisu* project, which is to be created in the *SPEED7 Studio*.
 - PROFINET IO controller or the PROFINET I-Device.

Assembly and commissioning

1. ➤ Install your System MICRO with your CPU.
2. ➤ Wire the system by connecting cables for voltage supply and signals.
3. ➤ Connect the one of the Ethernet jacks (X3, X4) of the Ethernet PG/OP channel to Ethernet.
4. ➤ Switch on the power supply.
 - ⇒ After a short boot time the CP is ready for communication. He possibly has no IP address data and requires an initialization.

"Initialization"

You get valid IP address parameters from your system administrator. The assignment of the IP address data happens online in the *SPEED7 Studio* with the following proceeding:

X3 PG/OP1



X4 PG/OP2



MAC PG/OP: 00-20-D5-77-05-10

1. ➤ Ethernet PG/OP
 - Determine the current Ethernet (MAC) address of your Ethernet PG/OP channel. This can be found at the front of the CPU labelled as "MAC PG/OP: ...".
2. ➤ Start the *SPEED7 Studio* with your project.

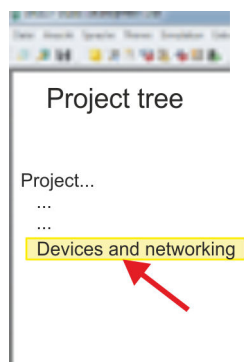

3. Click in the *Project tree* at '*Devices and networking*'.
⇒ You will get a graphical object view of your CPU.



4. Click at the network '*PG_OP_Ethernet*'.
5. Select '*Context menu* → *Determine accessible partner*'.
⇒ A dialog window opens.

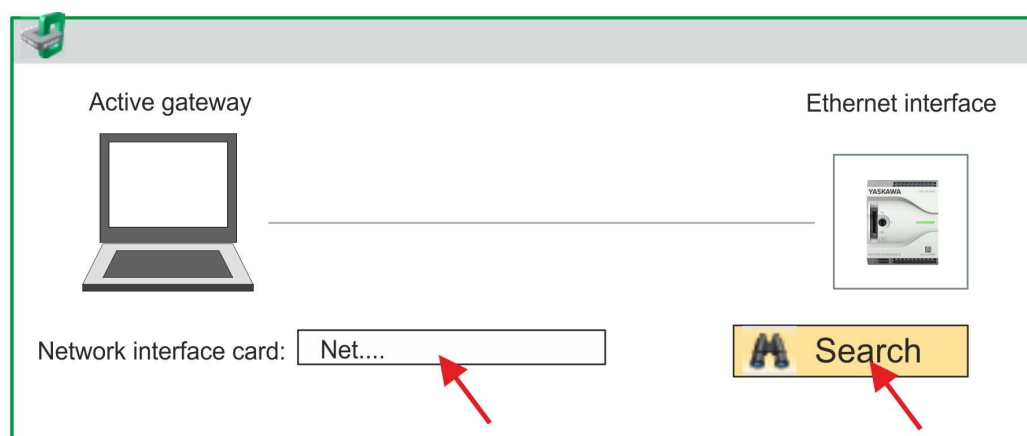

6. Select the according network interface card, which is connected to the Ethernet PG/OP channel and click at '*Search*' to determine the via MAC address reachable device.
⇒ The network search is started and the found stations are listed in a table.

7.

	Devices...	IP...	MAC...	Device...
1		172.20. ...	00:20: ...	VIPA ...		
2			

Click in the list at the module with the known MAC address. This can be found at the front of the CPU labelled as "MAC PG/OP: ...".

8. Click at '*Set IP address*'. Now set the IP configuration by entering '*IP address*', '*Subnet mask*' and '*Gateway*'.
9. Click at '*Set IP address*'.
⇒ The IP address is transferred to the module and the list is refreshed. Directly after the assignment the Ethernet PG/OP channel is online reachable using the set IP address data. The value remains as long as it is reassigned, it is overwritten by a hardware configuration or a factory reset is executed.
10. With clicking at '*Apply settings*' the IP address data a stored in the project.

Take IP address parameters in project

If you are not online, you can assign IP address data to your Ethernet PG/OP channel with following proceeding:

1. ➤ Start the *SPEED7 Studio* with your project.
2. ➤ Click in the *Project tree* at '*Devices and networking*'.
⇒ You will get a graphical object view of your CPU.



3. ➤ Click at the network '*PG_OP_Ethernet*'.
4. ➤ Select '*Context menu* → *Interface properties*'.
⇒ A dialog window opens. Here you can enter the IP address data for your Ethernet PG/OP channel.
5. ➤ Confirm with [OK].
⇒ The IP address data are stored in your project listed in '*Devices and networking*' at '*Local components*'.

After transferring your project your CPU can be accessed via Ethernet PG/OP channel with the set IP address data.

Local components

Slot	ModuleIP address	...
0	CPU M13-CCF0000			...	
...	
-X3	PG_OP_Ethernet			172.20.120.40	
...	

10.5 SPEED7 Studio - Hardware configuration - I/O modules

Hardware configuration of the modules

1. ➤ Click in the '*Project tree*' at '*PLC... > Device configuration*'.
2. ➤ Starting with slot 1 place in the '*Device configuration*' yourSystem MICRO modules in the plugged sequence. For this drag from the hardware catalog the corresponding module to the corresponding position in the *Device configuration*.

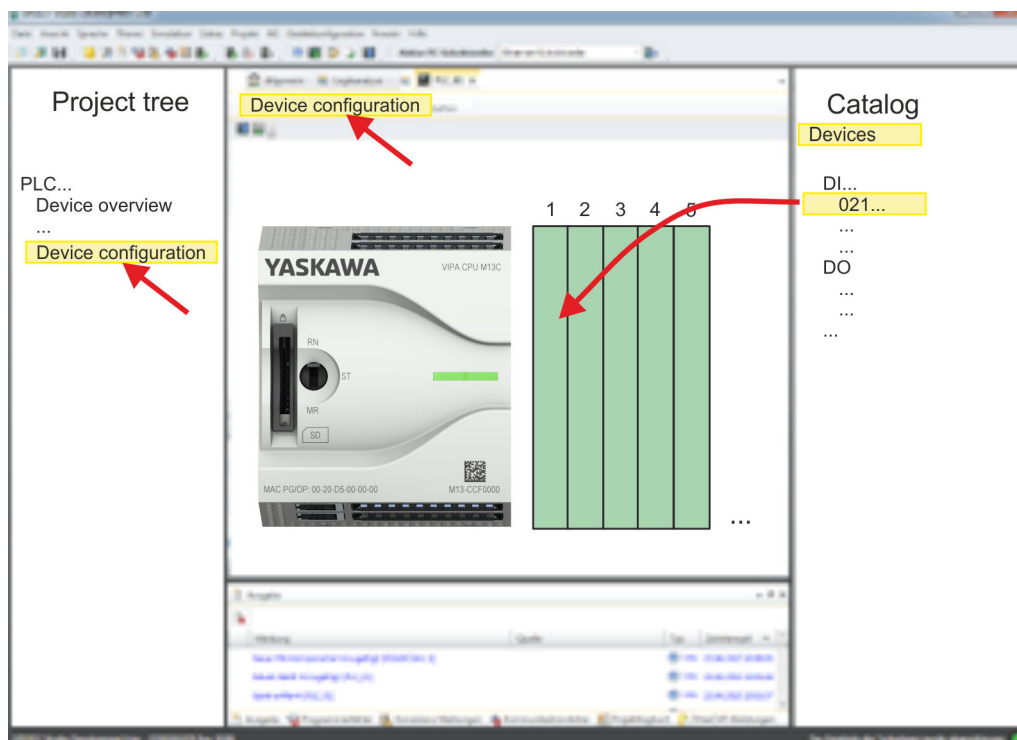

Parametrization

For parametrization double-click in the 'Device configuration' on the module you want to parametrize. Then the parameters of the module are shown in a dialog. Here you can make your parameter settings.

Parametrization during runtime

By using the SFCs 55, 56 and 57 you may alter and transfer parameters for wanted modules during runtime. For this you have to store the module specific parameters in so called "record sets". More detailed information about the structure of the record sets is to find in the according module description.

10.6 Deployment I/O periphery

10.6.1 Overview

Project engineering and parametrization

- On this CPU the connectors for digital respectively analog signal and *Technological functions* are combined in a one casing.
- Die Project engineering happens in the VIPA SPEED7 Studio as CPU M13-CCF0000.
- For parametrization of the digital I/O periphery and the *technological functions* the corresponding sub modules of the CPUM13-CCF0000 are to be used.
- The controlling of the operating modes of the *technological functions* happens by means of handling blocks of the user program.

10.6.2 Analog input

10.6.2.1 Overview

- 2xUx12Bit (0 ... 10V)
- Sub module 'A/2'
- ↪ Chap. 5.3 'Analog input' page 108

Deployment I/O periphery > Analog input

10.6.2.2 Parametrization in *SPEED7 Studio*

10.6.2.2.1 'I/O addresses'

Sub module	Input address	Access	Assignment
AI2	800	WORD	Analog input channel 0 (X4)
	802	WORD	Analog input channel 1 (X4)

10.6.2.2.2 'Parameter'

'Filtering channel 0/1'

The analog input part has a filter integrated. The parametrization of the filter happens via the parameter '*Filter channel 0/1*'. The default value of the filter is 1000ms. The following values can be entered:

- 2ms: no filter
- 100ms: small filter
- 1000ms: medium filter
- 10000ms: maximum filter

10.6.3 Digital input

10.6.3.1 Overview

- 16xDC 24V
- Sub module 'DI16/DO12'
- ↗ Chap. 5.4 'Digital input' page 111

10.6.3.2 Parametrization in SPEED7 Studio

10.6.3.2.1 'I/O addresses'

Sub module	Input address	Access	Assignment
DI16/DO12	136	BYTE	Digital input I+0.0 ... I+0.7 (X4)
	137	BYTE	Digital input I+1.0 ... I+1.7 (X4)

10.6.3.2.2 'Inputs'

'Trigger for process interrupt'

Here you can specify a hardware interrupt for each input in groups of 2 channels for the corresponding edge. The hardware interrupt is disabled, if nothing is selected (default setting). A diagnostics interrupt is only supported with *Hardware interrupt lost*.

Here is valid:

- Rising edge: Edge 0-1
- Falling edge: Edge 1-0

Input delay

- The input delay can be configured per channel in groups of 4.
- An input delay of 0.1ms is only possible with "fast" inputs, which have a max. input frequency of 100kHz ↗ Chap. 5.4 'Digital input' page 111. Within a group, the input delay for slow inputs is limited to 0.5ms.
- Range of values: 0.1ms / 0.5ms / 3ms / 15ms

10.6.4 Digital output

10.6.4.1 Overview

- 12xDC 24V, 0.5A
- Sub module 'DI16/DO12'
- ↗ Chap. 5.5 'Digital output' page 115

10.6.4.2 Parametrization in SPEED7 Studio

10.6.4.2.1 'I/O addresses'

Sub module	Output address	Access	Assignment
DI16/DO12	136	BYTE	Digital output Q+0.0 ... Q+0.7 (X5)
	137	BYTE	Digital output Q+1.0 ... Q+1.3 (X5)

10.6.5 Counter

10.6.5.1 Overview

- 4 channels
- Sub module: 'Count'
- [↪ Chap. 5.6 'Counting' page 118](#)

10.6.5.2 Parametrization in *SPEED7 Studio*

10.6.5.2.1 'I/O addresses'

Sub module	Input address	Access	Assignment
Count	816	DINT	Channel 0: Counter value / Frequency value
	820	DINT	Channel 1: Counter value / Frequency value
	824	DINT	Channel 2: Counter value / Frequency value
	828	DINT	Channel 3: Counter value / Frequency value

10.6.5.2.2 Basic parameters

Select interrupt

Via 'Basic parameters' you can reach 'Select interrupt'. Here you can define the interrupts the CPU will trigger. The following parameters are supported:

- None: The interrupt function is disabled.
- Process: The following events of the counter can trigger a hardware interrupt (selectable via 'Count'):
 - Hardware gate opening
 - Hardware gate closing
 - On reaching the comparator
 - on Counting pulse
 - on overflow
 - on underflow
- Diagnostics+process: A diagnostics interrupt is only triggered when a hardware interrupt was lost.

10.6.5.2.3 'Channel x'

Operating mode

Select via 'Channel' the channel select via 'Operating' the counter operating mode. The following counter operating modes are supported:

- Not parametrized: Channel is de-activated
- Count endless
- Count once
- Count periodical

Counter

Operating mode

Default values and structure of this dialog box depend on the selected 'Operating mode'.

Parameter overview

Operating parameters	Description	Assignment
Main count direction	<ul style="list-style-type: none"> ■ <i>None</i> No restriction of the counting range ■ <i>Up</i>: Restricts the up-counting range. The counter starts from 0 or <i>load value</i>, counts in positive direction up to the declaration <i>end value</i> -1 and then jumps back to <i>load value</i> at the next positive transducer pulse. ■ <i>Down</i>: Restricts the down-counting range. The counter starts from the declared <i>start value</i> or <i>load value</i> in negative direction, counts to 1 and then jumps to <i>start value</i> at the next negative encoder pulse. Function is disable with <i>count continuously</i>. 	<ul style="list-style-type: none"> ■ None
Gate function	<ul style="list-style-type: none"> ■ <i>Cancel count</i>: The count starts when the gate opens and resumes at the <i>load value</i> when the gate opens again. ■ <i>Stop count</i>: The count is interrupted when the gate closes and resumed at the last actual counter value when the gate opens again. <p>🔗 <i>Chap. 5.6.6.2 'Gate function' page 133</i></p>	Abort count process
Start value End value	<p><i>Start value</i> with counting direction backward. <i>End value</i> with main counting direction forward.</p> <p>Range of values: 2...2147483647 ($2^{31}-1$)</p>	2147483647 ($2^{31}-1$)
Comparison value	<p>The count value is compared with the <i>comparison value</i>. See also the parameter "Characteristics of the output":</p> <ul style="list-style-type: none"> ■ No main counting direction <ul style="list-style-type: none"> – Range of values: -2^{31} to $+2^{31}-1$ ■ Main counting direction forward <ul style="list-style-type: none"> – Range of values: -2^{31} to end value-1 ■ Main counting direction backward <ul style="list-style-type: none"> – Range of values: 1 to $+2^{31}-1$ 	0
Hysteresis	<p>The <i>hysteresis</i> serves the avoidance of many toggle processes of the output, if the counter value is in the range of the <i>comparison value</i>.</p> <p>0, 1: <i>Hysteresis</i> disabled</p> <p>Range of values: 0 to 255</p>	0

Input	Description	Assignment
Signal evaluation	<p>Specify the signal of the connected encoder:</p> <ul style="list-style-type: none"> ■ Pulse/direction At the input count and direction signal are connected ■ At the input there is an encoder connected with the following evaluation: <ul style="list-style-type: none"> – Rotary encoder single – Rotary encoder double – Rotary encoder quadruple 	Pulse/direction
Hardware gate	<p>Gate control exclusively via channel 3:</p> <ul style="list-style-type: none"> ■ enabled: The gate control for channel 3 happens via SW and HW gate ■ disabled: The gate control for channel 3 exclusively happens via SW gate <p>🔗 <i>Chap. 5.6.6.2 'Gate function' page 133</i></p>	disabled
Count direction inverted	<p>Invert the input signal '<i>Direction</i>':</p> <ul style="list-style-type: none"> ■ enabled: The input signal is inverted ■ disabled: The input signal is not inverted 	disabled

Output	Description	Assignment
Characteristics of the output	<p>The output and the "Comparator" (STS_CMP) status bit are set, dependent on this parameter.</p> <ul style="list-style-type: none"> ■ No comparison: The output is used as normal output and STS_CMP remains reset. ■ Comparator <ul style="list-style-type: none"> – Counter value \geq Comparison value – Counter value \leq Comparison value ■ Pulse at <i>comparison value</i> <ul style="list-style-type: none"> – To adapt the used actuators you can specify a <i>pulse duration</i>. The output is set for the specified <i>pulse duration</i> when the counter value reaches the <i>comparison value</i>. When you've set a main counting direction the output is only set at reaching the <i>comparison value</i> from the main counting direction. 	No comparison
Pulse duration	<p>Here you can specify the <i>pulse duration</i> for the output signal.</p> <ul style="list-style-type: none"> ■ The <i>pulse duration</i> starts with the setting of the according digital output. ■ The inaccuracy of the <i>pulse duration</i> is less than 1ms. ■ There is no past triggering of the <i>pulse duration</i> when the <i>comparison value</i> has been left and reached again during pulse output. ■ If the <i>pulse duration</i> is changed during operation, it will take effect with the next pulse. ■ If the <i>pulse duration</i> = 0, the output is set until the comparison condition is not longer fulfilled. <p>Range of values: 0...510ms in steps of 2ms</p>	0

Frequency	Description	Assignment	
Max. counting frequency	Specify the max. frequency for track A/pulse, track B/direction, Latch and HW gate	60kHz	
	Frequency		shortest permissible count pulse
	1kHz		400µs
	2kHz		200µs
	5kHz		80µs
	10kHz		40µs
	30kHz		13µs
	60kHz		6.7µs
	100kHz		4µs

Hardware interrupt	Description	Assignment
Hardware gate opening	Hardware interrupt by edge 0-1 exclusively at HW gate channel 3 <ul style="list-style-type: none"> ■ enabled: Process interrupt by edge 0-1 exclusively at HW gate channel 3 with open SW gate ■ disabled: no hardware interrupt 	disabled
Hardware gate closing	Hardware interrupt by edge 1-0 exclusively at HW gate channel 3 <ul style="list-style-type: none"> ■ enabled: Process interrupt by edge 1-0 exclusively at HW gate channel 3 with open SW gate ■ disabled: no hardware interrupt 	disabled
On reaching comparator	Hardware interrupt on reaching <i>comparator</i> <ul style="list-style-type: none"> ■ enabled: Hardware interrupt when comparator is triggered, can be configured via '<i>Characteristics of the output</i>' ■ disabled: no hardware interrupt 	disabled
Overflow	Hardware interrupt overflow <ul style="list-style-type: none"> ■ enabled: Hardware interrupt on overflow the upper counter limit ■ disabled: no hardware interrupt 	disabled
Underflow	Hardware interrupt on underrun <ul style="list-style-type: none"> ■ enabled: Hardware interrupt on underflow the lower counter limit ■ disabled: no hardware interrupt 	disabled

10.6.6 Frequency measurement

10.6.6.1 Overview

- 4 channels
- Sub module ‘Counter’
- ↪ *Chap. 5.7 ‘Frequency measurement’ page 140*

10.6.6.2 Parametrization in *SPEED7 Studio*

10.6.6.2.1 ‘I/O addresses’

Sub module	Input address	Access	Assignment
<i>Count</i>	816	DINT	Channel 0: Counter value / Frequency value
	820	DINT	Channel 1: Counter value / Frequency value
	824	DINT	Channel 2: Counter value / Frequency value
	828	DINT	Channel 3: Counter value / Frequency value

Sub module	Output address	Access	Assignment
<i>Count</i>	816	DWORD	reserved
	820	DWORD	reserved
	824	DWORD	reserved
	828	DWORD	reserved

10.6.6.2.2 Basic parameters

Select interrupt

Via ‘*Basic parameters*’ you can reach ‘*Select interrupt*’. Here you can define the interrupts the CPU will trigger. The following parameters are supported:

- None: The interrupt function is disabled.
- Process: The following events of the frequency measurement can trigger a hardware interrupt (selectable via ‘*Frequency counting*’):
 - End of measurement
- Diagnostics+process: A diagnostics interrupt is only triggered when a hardware interrupt was lost.

10.6.6.2.3 ‘Channel x:’

Operating mode

Select via ‘*Channel*’ the channel and select for frequency measurement via ‘*Operating mode*’ the operating mode ‘*Frequency counting*’. Default values and structure of this dialog box depend on the selected ‘*Operating mode*’. The following parameters are supported:

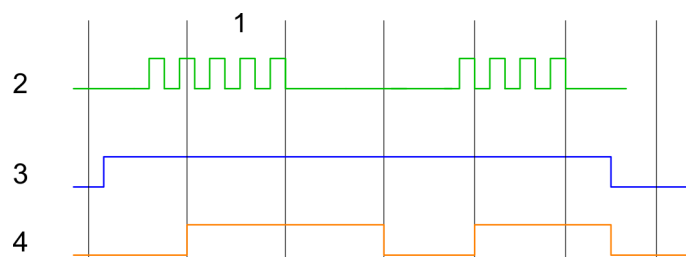

- 1 Integration time
- 2 Counting pulse
- 3 SW gate
- 4 Evaluated frequency

Parameter overview

Operating parameters	Description	Assignment	
Integration time	Specify the integration time Range of values: 10ms ... 10000ms in steps of 1ms	100ms	
max. counting frequency ...	Specify the max. frequency for the corresponding input	60kHz	
	Frequency		shortest permissible count pulse
	1kHz		400µs
	2kHz		200µs
	5kHz		80µs
	10kHz		40µs
	30kHz		13µs
	60kHz		6.7µs
	100kHz		4µs
Hardware interrupt	Description	Assignment	
End of measurement	Hardware interrupt at end of measurement	de-activated	

10.6.7 Pulse width modulation - PWM

10.6.7.1 Overview

- Channel 0 and 1 are supported
- Sub module 'Count'
- Control by the user program via SFB 49
- ↗ *Chap. 5.8 'Pulse width modulation - PWM' page 146*

10.6.7.2 Parametrization in *SPEED7 Studio*

10.6.7.2.1 'I/O addresses'

Sub module	Input address	Access	Assignment
Count	816	DINT	reserved
	820	DINT	reserved
	824	DINT	reserved
	828	DINT	reserved

Sub module	Output address	Access	Assignment
Count	816	DWORD	reserved
	820	DWORD	reserved
	824	DWORD	reserved
	828	DWORD	reserved

10.6.7.2.2 'Channel x'

Operating mode

PWM and pulse train output use the same hardware configuration. Switching between these modes is done within the SFB 49. Select via 'Channel x' the channel and select for pulse width modulation via 'Operating mode' the operating mode 'Pulse width modulation'. Default values and structure of this dialog box depend on the selected 'Operating mode'. The following parameters are relevant for PWM, which must be specified or determined:

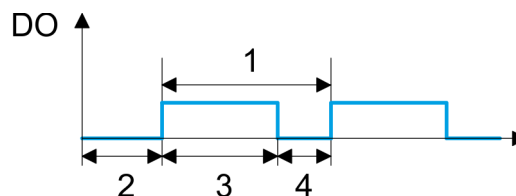

- 1 Period
- 2 On-delay
- 3 Pulse duration
- 4 Pulse pause

Parameter overview

Operating parameters	Description	Assignment
Output format	<p>Here specify the range of values for the output. The CPU hereby determines the pulse duration:</p> <ul style="list-style-type: none"> ■ Per mil <ul style="list-style-type: none"> – Output value is within 0 ... 1000 – Pulse duration = (Output value / 1000) x Period ■ S7 Analog value: <ul style="list-style-type: none"> – Output value is Siemens S7 analog value 0 ... 27648 – Pulse duration = (Output value / 27648) x Period 	Per mil
Time base	<p>Here you can set the time base, which will apply for resolution and range of values of the period duration, minimum pulse duration and on-delay.</p> <ul style="list-style-type: none"> ■ 1ms: The time base is 1ms ■ 0.1ms: The time base is 0.1ms ■ 1µs: The time base is 1µs 	0.1ms
On-delay	<p>Enter here a value for the time to expire from the start of the output sequence to the output of the pulse. The pulse sequence is output at the output channel, on expiration of the on-delay.</p> <p>Range of values: 0 ... 65535 from this there are the following effective values:</p> <ul style="list-style-type: none"> ■ Time base 1ms: 0 ... 65535ms ■ Time base 0.1ms: 0 ... 6553.5ms ■ Time base 1µs: 0 ... 65535µs 	0
Period	<p>With the period you define the length of the output sequence, which consists of pulse duration and pulse pause.</p> <p>Range of values:</p> <ul style="list-style-type: none"> ■ Time base 1ms: 1 ... 87ms ■ Time base 0.1ms: 0.4 ... 87.0ms ■ Time base 1µs: 1 ... 87µs 	20000
Minimum pulse duration	<p>With the minimum pulse duration you can suppress short output pulses and short pulse pauses. All pulses or pauses, which are smaller than the minimum pulse duration, are suppressed. This allows you to filter very short pulses (spikes), which can not be recognized by the periphery.</p> <p>Range of values:</p> <ul style="list-style-type: none"> ■ Time base 1ms: 0 ... Period / 2 * 1ms ■ Time base 0.1ms: 2 ... Period / 2 * 0.1ms ■ Time base 1µs: 0 ... Period / 2 * 1µs 	2

10.6.8 Pulse train

10.6.8.1 Overview

- 2 channels
- Sub module 'Count'
- Control by the user program via SFB 49
- [↗ Chap. 5.9 'Pulse train' page 151](#)

10.6.8.2 Parametrization in *SPEED7 Studio*

10.6.8.2.1 'I/O addresses'

Sub module	Input address	Access	Assignment
Count	816	DINT	reserved
	820	DINT	reserved
	824	DINT	reserved
	828	DINT	reserved

Sub module	Output address	Access	Assignment
Count	816	DWORD	reserved
	820	DWORD	reserved
	824	DWORD	reserved
	828	DWORD	reserved

10.6.8.2.2 'Channel x'

Operating mode

PWM and *pulse train* output use the same hardware configuration. Switching between these modes is done within the SFB 49. Select via 'Channel x' the channel and select for pulse train via 'Operating mode' the operating mode 'Pulse width modulation'. Default values and structure of this dialog box depend on the selected 'Operating mode'. The following parameters are relevant for pulse train, which must be specified or determined:

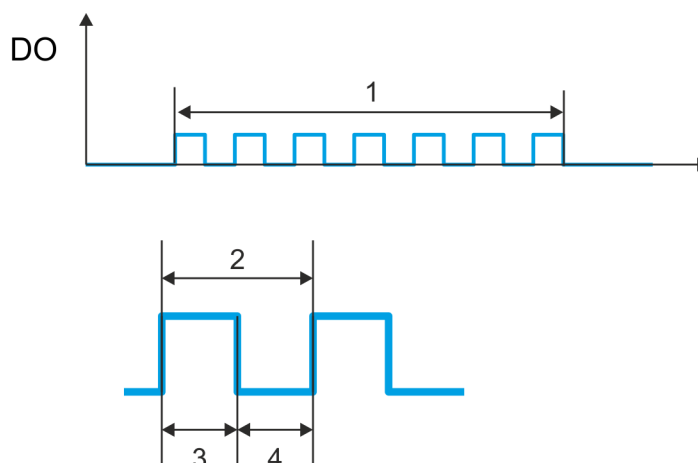

- 1 Number of pulses
- 2 Period duration
- 3 Pulse duration
- 4 Pulse pause

Parameter overview

Operating parameters	Description	Assignment
Output format	<p>Here specify the range of values for the output. The CPU hereby determines the pulse duration:</p> <ul style="list-style-type: none"> ■ Per mil <ul style="list-style-type: none"> – Output value is within 0 ... 1000 – Pulse duration = (Output value / 1000) x Period ■ S7 Analog value: <ul style="list-style-type: none"> – Output value is Siemens S7 analog value 0 ... 27648 – Pulse duration = (Output value / 27648) x Period 	Per mil
Time base	<p>Here you can set the time base, which will apply for resolution and range of values of the period duration, minimum pulse duration and on-delay.</p> <ul style="list-style-type: none"> ■ 1ms: The time base is 1ms ■ 0.1ms: The time base is 0.1ms ■ 1µs: The time base is 1µs 	0.1ms
On-delay	This parameter is ignored.	0

Operating parameters	Description	Assignment
Period	<p>With the period you define the length of the output sequence, which consists of pulse duration and pulse pause.</p> <p>Range of values:</p> <ul style="list-style-type: none"> ■ Time base 1ms: 1 ... 87ms ■ Time base 0.1ms: 0.4 ... 87.0ms ■ Time base 1µs: 1 ... 87µs 	50
Minimum pulse duration	<p>With the minimum pulse duration you can suppress short output pulses and short pulse pauses. All pulses or pauses, which are smaller than the minimum pulse duration, are suppressed. This allows you to filter very short pulses (spikes), which can not be recognized by the periphery.</p> <p>Range of values:</p> <ul style="list-style-type: none"> ■ Time base 1ms: 0 ... $\text{Period} / 2 * 1\text{ms}$ ■ Time base 0.1ms: 2 ... $\text{Period} / 2 * 0.1\text{ms}$ ■ Time base 1µs: 0 ... $\text{Period} / 2 * 1\mu\text{s}$ 	2

10.7 Deployment Web visualization

- With a *WebVisu* project there is the possibility to configure a web visualization on your CPU.
- The configuration of a *WebVisu* project is only possible with the *SPEED7 Studio V 1.7* and up.
- Since a *WebVisu* project is only executable by memory card, a memory card of VIPA (VSD, VSC) must be plugged.
 ↳ *Chap. 4.15 'Deployment storage media - VSD, VSC' page 98*
- The *WebVisu* functionality must be activated in the CPU.
 ↳ *Chap. 10.7.1 'Activate WebVisu functionality' page 249*
- When the project is transferred from the *SPEED7 Studio*, the *WebVisu* project is automatically transferred to the inserted memory card.
- Access happens by the IP address of the Ethernet PG/OP channel and the correspondingly configured port or via the *device web page*
- You can access your web visualization via a web browser. Web browsers based on Windows CE are currently not supported.



Please note that the use of a WebVisu project, depending on the scope of the WebVisu project and the PLC project, can influence the performance and thus the response time of your application.

10.7.1 Activate *WebVisu* functionality

Proceeding

For your CPU can process a *WebVisu* project, you have to activate the *WebVisu* functionality.

1. ➤ Insert a memory card from VIPA (VSD, VSC) into your CPU. ↪ *Chap. 4.15 'Deployment storage media - VSD, VSC' page 98*
2. ➤ Turn on the CPU, to activate the *WebVisu* functionality, you have to establish an *Overall reset*.
 - ⇒ As long as the memory card is inserted, the *WebVisu* functionality remains activated even after a power cycle. When the project is transferred from the *SPEED7 Studio*, the *WebVisu* project is automatically transferred to the inserted memory card.



*Please regard that the memory card must remain plugged when you've executed activated the *WebVisu* functionality. Otherwise the red LED of the status bar  blinks with 1Hz in RUN and the *WebVisu* functionality is deactivated after 72 hours. As long as an activated memory card is not inserted, the LED blinks and the "TrialTime" timer counts from 72 hours down to 0. After that the *WebVisu* functionality is de-activated. By inserting the memory card, the LED goes off and the CPU runs again without restrictions.*

10.7.2 *WebVisu* editor

The configuration of a *WebVisu* project is shown below. This is only the basic use of the *WebVisu* editor in the *SPEED7 Studio* together with the VIPA CPU. Please note that software changes can not always be considered and it may thus be deviations to the description.



*For more information on the *SPEED7 Studio* and how to use the *WebVisu* editor, refer to its online help.*

10.7.2.1 Working environment

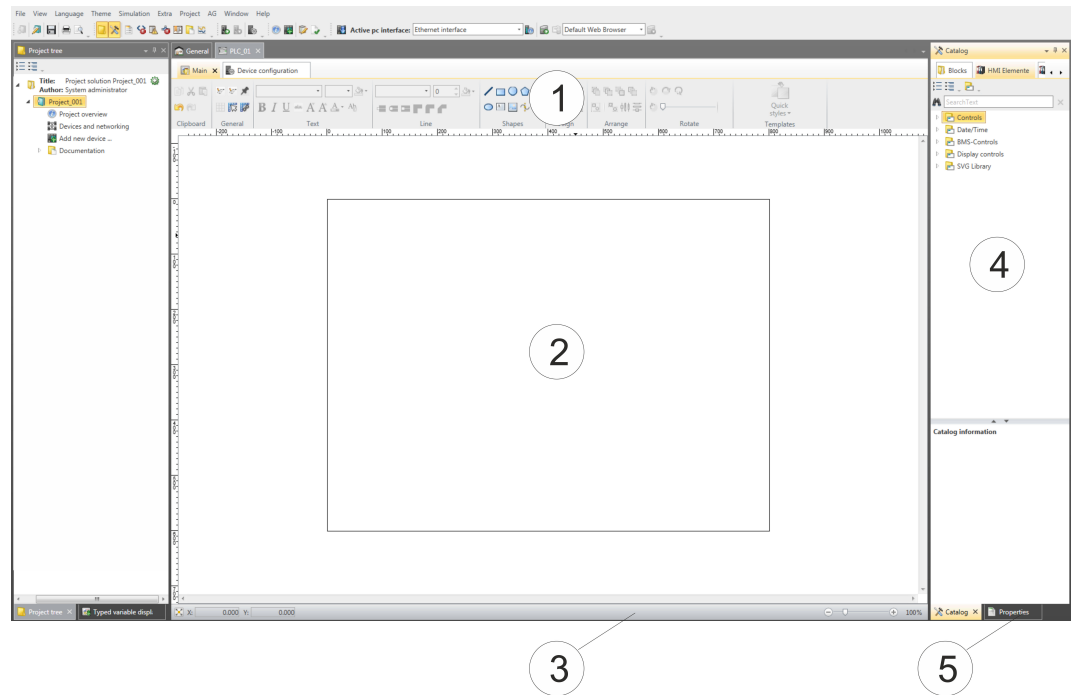

- (1) Toolbar
- (2) Editor surface
- (3) Status bar
- (4) Catalog
- (5) Properties window

(1) Toolbar

The toolbar provides important commands for working with the *WebVisu* editor.

(2) Editor area

The editor area is your workspace. Here you can place and edit texts and graphics objects.

(3) Status bar

With a slider you can enlarge or reduce your view.

(4) Catalog

Via *Catalog* you can access all the *WebVisu* elements. You can use Drag & Drop to place them on the *Editor surface* and adjust them using properties.

(5) Properties window

By enabling 'View → Properties' the 'Properties' are shown. The properties of the selected element are shown here. You can adjust these if necessary.

10.7.2.2 Creating a *WebVisu* project

Add *WebVisu*

1. Start the *SPEED7 Studio* with your project for the CPU for which a *WebVisu* project is to be created.
2. If not already done, add a CPU by clicking 'Add new device'.
3. Click in the 'Project tree' at the CPU and select 'Context menu → Device properties'.
 - ⇒ The 'Device properties' of your CPU opens.

4. Here click at '*WebVisu configuration*'

⇒ In this settings window, you can create a *WebVisu* project for your CPU.

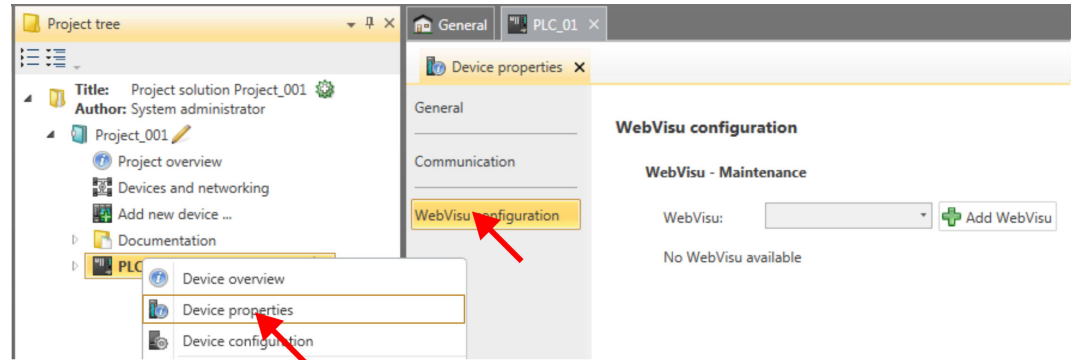

5. To create a *WebVisu* project, click at [+ Add WebVisu].

⇒ A new *WebVisu* project is created and listed in the '*Project tree*'. At '*WebVisu - general configurations*' and '*WebVisu - SSL configurations*', you can make further settings.

WebVisu - general configurations

- Port number
 - Enter the port number under which the *WebVisu* should be accessible.
 - *Port number: 8080 (default):* The *WebVisu* can be accessed via the IP address and port 8080. The *Device web page* can be accessed via the IP address and port 80.
 - *Port number: 80:* The *WebVisu* can be accessed via the IP address and port 80. The *Device web page* can be accessed via the IP address and port 8080.
- Polling interval (ms)
 - Enter here the interval for the cyclical refresh of the web content.
- Execution device
 - Select '*CPU*' as device on which this *WebVisu* project is to be executed.
 - *WebVisu* projects for Ethernet CPs are not supported by this CPU.

WebVisu - SSL configurations

- Enabling encoding
 - When enabled, you have SSL-encrypted access to your *WebVisu*.
- Disable HTTP
 - When activated, the access happens via HTTPS.
- SSL port number
 - SSL port number 443 (default): The secure access to the *WebVisu* takes place via the IP address and port 443. The *Device web page* can be accessed via the IP address of the CPU and port 8080.
- Original path of the certificate used
 - Here you can upload a security certificate.
 - Only security certificates in PEM format are supported.

Delete *WebVisu*

→ Click in the '*Project tree*' at *WebVisu* Project and select '*Context menu*' → '*Delete WebVisu*'.

⇒ The *WebVisu* project is removed from the configuration.

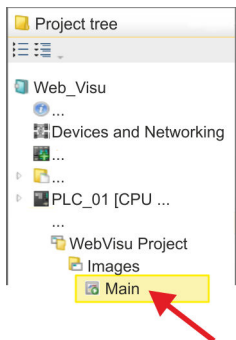
Edit WebVisu

➔ In the 'Project tree', navigate to 'WebVisu Project > Images' and click at 'Main'. Select 'Context menu → Open image'

⇒ The WebVisu editor opens. Here, you can configure your web visualization by dragging and dropping elements from the 'Catalog' onto the editor area and using the 'Properties' to interconnect them with a variable.

10.7.3 Start-up of the WebVisu project

The following preconditions must be fulfilled for the WebVisu project to start-up:

1. ➔ Activate WebVisu functionality if not already done. ↪ Chap. 10.7.1 'Activate Web-Visu functionality' page 249
2. ➔ Configure your CPU and perform a hardware configuration.
3. ➔ Configure your WebVisu project.
4. ➔ Safe and translate your project.
5. ➔ If you are online connected to your CPU, you can transfer your project to the CPU with 'AG → Transfer all'.
 - ⇒ Here the configuration is transferred in the CPU and the WebVisu project is transferred to the memory card. Immediately after the transfer you have access to your WebVisu.



You can use the CMD auto commands WEBVISU_PGOP_ENABLE and WEBVISU_PGOP_DISABLE to enable or disable the WebVisu. After a power cycle or loading a hardware configuration, the settings are retained. With reset to the factory settings or over all reset, the WebVisu project is set to the default value "enabled". ↪ Chap. 4.17 'CMD - auto commands' page 102

10.7.4 Access to the WebVisu

Via the web server of the CPU, you have access to the device web page and the *WebVisu*, controlled via ports. Access to the *WebVisu* can be password-protected and encrypted by means of SSL certificates. If you want to use SSL certificates, you must integrate them in the *SPEED7 Studio* accordingly.

- You can create users via '*Webvisu Project > User administration*', who can access the *WebVisu*.
- Via '*Device properties > WebVisu Configuration*', you can specify the port via which the *WebVisu* should be reached and upload security certificates. This changes the port for accessing the device web page.
 - HTTP port 8080 (default): The *WebVisu* can be accessed via the IP address of the CPU with port number, such as <http://192.168.72.120:8080>. The device web page can be accessed via the IP address of the CPU (port 80), such as <http://192.168.72.120>.
 - HTTP port 80: The *WebVisu* can be accessed via the IP address of the CPU, such as <http://192.168.72.120>. The device web page can be accessed via the IP address of the CPU and port 8080, such as <http://192.168.72.120:8080>.
 - SSL port 443 (default): The *WebVisu* can secure be accessed via the IP address of the CPU with port number, such as <https://192.168.72.120:443>. The device web page can be accessed via the IP address of the CPU and port 8080, such as <http://192.168.72.120:8080>.



Please note that the encryption of the communication can affect CPU performance and therefore the response time of the entire system!

10.7.5 Status of the WebVisu

On the device web page at the tab '*WebVisu*' via '*Status*' you get the status of your *WebVisu* project. You can also determine the status at runtime by using the SSL partial list xy3Eh. More can be found in the manual operation list (HB00_OPL_SP7) of your CPU.

Status	Meaning
running	<i>WebVisu</i> is active / has started-up and can be opened
loading webvisu project	Loading <i>WebVisu</i> project
shutting down	<i>WebVisu</i> server shuts down
stop requested	<i>WebVisu</i> STOP requested
stopped	<i>WebVisu</i> server is down
webvisu feature not activated	<i>WebVisu</i> not activated, memory card is not inserted
webvisu is disabled by the user	<i>WebVisu</i> was disabled by the user
no webvisu project file found	No <i>WebVisu</i> project found
no hardware configuration loaded	No hardware configuration is loaded
invalid configuration	Invalid <i>WebVisu</i> configuration
internal error: filesystem	Error initializing the file system
webvisu project file too large	Error loading <i>WebVisu</i> project, project file too large

Status	Meaning
loading webvisu project file	Error loading <i>WebVisu</i> project, project file may be damaged
deleting webvisu project	Failed to delete the <i>WebVisu</i> project
internal error: file system - delete	<i>WebVisu</i> project to be deleted was not found in the memory
CRC mismatch	CRC of the <i>WebVisu</i> project file is not correct
webvisu stopped	<i>WebVisu</i> server has terminated unexpectedly
internal error 1	Internal error - initialization failed step 1
internal error 2	Internal error - initialization failed step 2
internal error 3	Unexpected internal error
unknown error	General error

10.8 *SPEED7 Studio* - Project transfer

Overview

There are the following possibilities for project transfer into the CPU:

- Transfer via MPI
- Transfer via Ethernet
- Transfer via memory card

10.8.1 Transfer via MPI

General

For the transfer via MPI the use of the optionally available extension module EM M09 is required. The extension module provides the interface X2: MPI(PB) with fixed pin assignment. ↪ *Chap. 2.4 'Mounting' page 14*

Net structure

The structure of a MPI net is electrically identical with the structure of a PROFIBUS net. This means the same rules are valid and you use the same components for the build-up. The single participants are connected with each other via bus interface plugs and PROFIBUS cables. Per default the MPI net runs with 187.5kbaud. VIPA CPUs are delivered with MPI address 2.

MPI programming cable

The MPI programming cables are available at VIPA in different variants. The cables provide a RS232 res. USB plug for the PC and a bus enabled RS485 plug for the CPU. Due to the RS485 connection you may plug the MPI programming cables directly to an already plugged plug on the RS485 jack. Every bus participant identifies itself at the bus with an unique address, in the course of the address 0 is reserved for programming devices.

Terminating resistor

A cable has to be terminated with its surge impedance. For this you switch on the terminating resistor at the first and the last participant of a network or a segment. Please make sure that the participants with the activated terminating resistors are always power supplied. Otherwise it may cause interferences on the bus.

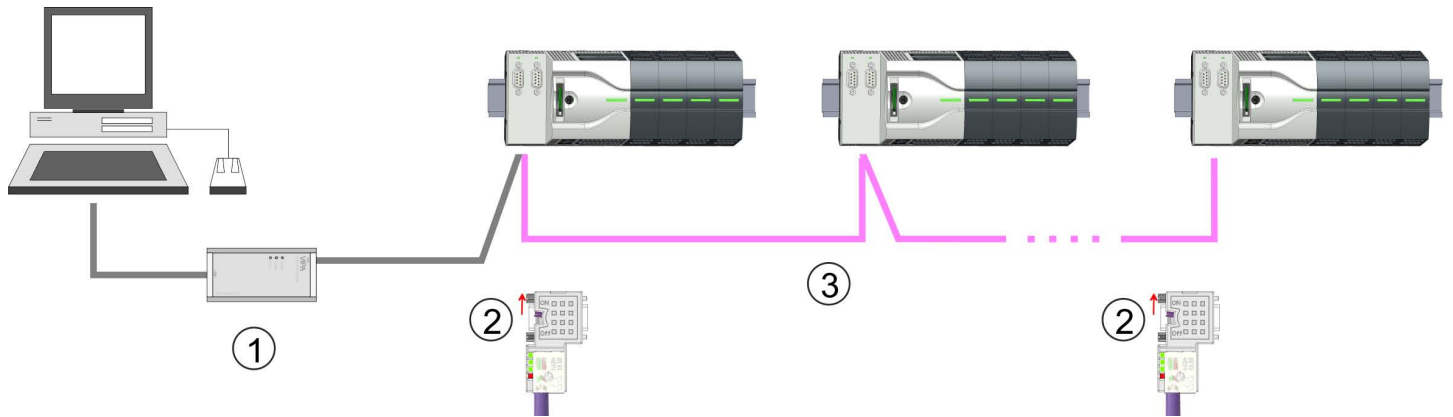

- 1 MPI programming cable
- 2 Activate the terminating resistor via switch
- 3 MPI network

Proceeding transfer via MPI

1. ➤ Connect your PC to the MPI jack of your CPU via a MPI programming cable.
2. ➤ Switch-ON the power supply of your CPU and start the *SPEED7 Studio* with your project.
3. ➤ Set at 'Active PC interface' the "Serial interface".
4. ➤ Click in the 'Project tree' to your project and select 'Context menu → Recompile'.
⇒ Your project will be translated and prepared for transmission.

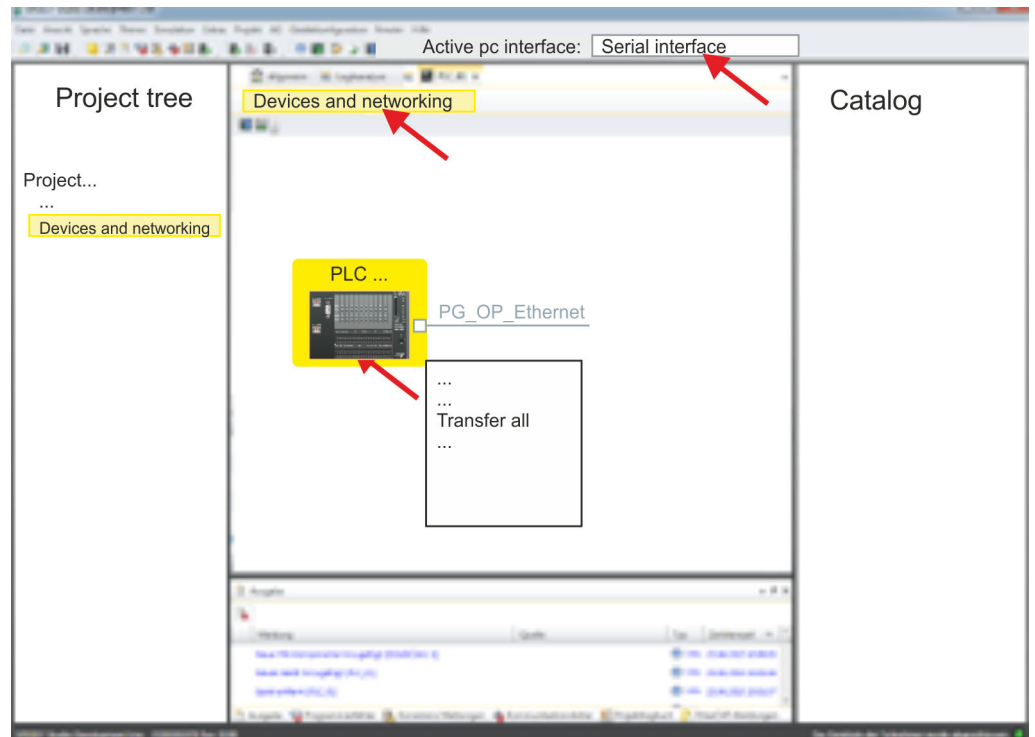

5. ➤ To transfer the user program and hardware configuration click in the *Project tree* at your CPU and select 'Context menu → Transfer all'.
⇒ A dialog window for project transfer opens
6. ➤ Select the 'Port type' "Serial interface" and start the transfer with 'Transfer'.

7. Confirm the request that the CPU is to be brought into the state STOP.
 - ⇒ The user program and the hardware configuration are transferred via MPI to the CPU.
8. Close after transmission the dialog.
9. With *'Context menu → Copy RAM to ROM'* you can save your project on a memory card, if one is plugged.

10.8.2 Transfer via Ethernet

Proceeding transfer via Ethernet

For transfer via Ethernet the CPU has an Ethernet PG/OP channel. For online access to this, you have to assign IP address parameters to this by means of "initialization" and transfer them into your project. For the transfer, connect, if not already done, the Ethernet PG/OP channel jack to your Ethernet. The connection happens via an integrated 2-port switch (X3, X4).

1. Switch-ON the power supply of your CPU and start the *SPEED7 Studio* with your project.
2. Set at *'Active PC interface'* the "Ethernet interface".
3. Click in the *'Project tree'* to your project and select *'Context menu → Recompile'*.
 - ⇒ Your project will be translated and prepared for transmission.

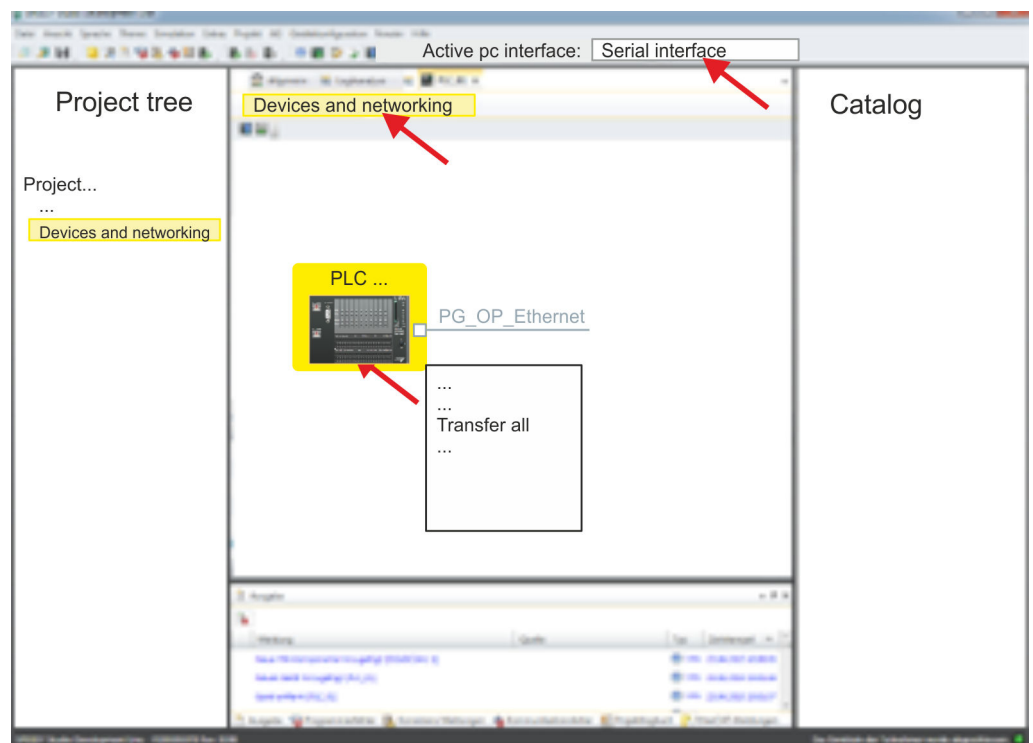

4. To transfer the user program and hardware configuration click in the *Project tree* at your CPU and select *'Context menu → Transfer all'*.
 - ⇒ A dialog window for project transfer opens
5. Select the *'Port type'* "Ethernet interface" and start the transfer with *'Transfer'*.
6. Confirm the request that the CPU is to be brought into the state STOP.
 - ⇒ The user program and the hardware configuration are transferred via Ethernet to the CPU.
7. Close after transmission the dialog.

8. ➤ With 'Context menu ➔ Copy RAM to ROM' you can save your project on a memory card, if one is plugged.

10.8.3 Transfer via memory card

Proceeding transfer via memory card

The memory card serves as external storage medium. There may be stored several projects and sub-directories on a memory card. Please regard that your current project is stored in the root directory and has one of the following file names:



- S7PROG.WLD
- AUTOLOAD.WLD

1. ➤ Start the *SPEED7 Studio* with your project.
2. ➤ Click in the 'Project tree' at the CPU.
3. ➤ Create in the *SPEED7 Studio* with 'Context menu ➔ Export device configuration (WLD)' a wld file.
 - ⇒ The wld file is created. This contains the user program and the hardware configuration
4. ➤ Copy the wld file at a suited memory card. Plug this into your CPU and start it again.

- ⇒ The transfer of the application program from the memory card into the CPU takes place depending on the file name after an overall reset or PowerON.

S7PROG.WLD is read from the memory card after overall reset.

AUTOLOAD.WLD is read from the memory card after PowerON.

The flickering of the yellow LED  of the status bar of the CPU marks the active transfer. Please regard that your user memory serves for enough space for your user program, otherwise your user program is not completely loaded and the red LED  of the status bar lights up.

11 Configuration with TIA Portal

11.1 TIA Portal - Work environment

11.1.1 General

General

In this chapter the project engineering of the VIPA CPU in the Siemens TIA Portal is shown. Here only the basic usage of the Siemens TIA Portal together with a VIPA CPU is shown. Please note that software changes can not always be considered and it may thus be deviations to the description. TIA means **T**otally **i**ntegrated **A**utomation from Siemens. Here your VIPA PLCs may be configured and linked. For diagnostics online tools are available.



Information about the Siemens TIA Portal can be found in the online help respectively in the according online documentation.

Starting the TIA Portal

To start the Siemens TIA Portal with Windows select 'Start → Programs → Siemens Automation → TIA ...'

Then the TIA Portal opens with the last settings used.

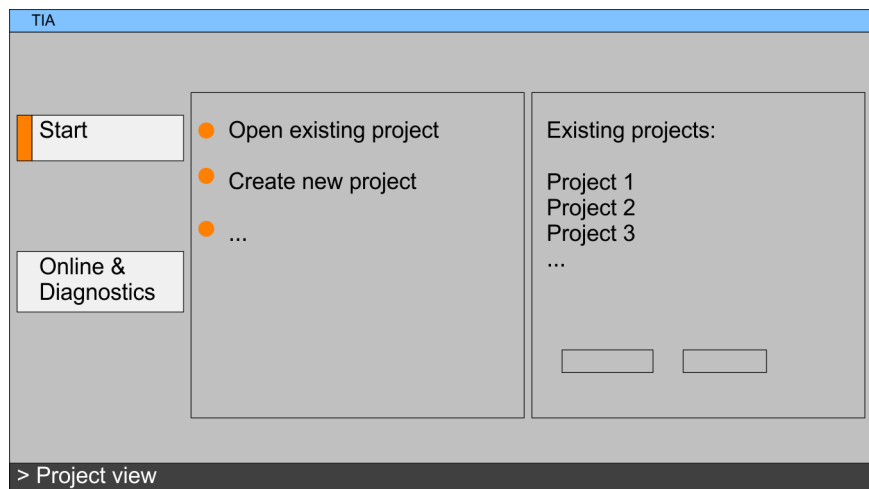

Exiting the TIA Portal

With the menu 'Project → Exit' in the 'Project view' you may exit the TIA Portal. Here there is the possibility to save changes of your project before.

11.1.2 Work environment of the TIA Portal

Basically, the TIA Portal has the following 2 views. With the button on the left below you can switch between these views:

Portal view

The *'Portal view'* provides a "task oriented" view of the tools for processing your project. Here you have direct access to the tools for a task. If necessary, a change to the Project view takes place automatically for the selected task.

Project view

The *'Project view'* is a "structured" view to all constituent parts of your project.

Areas of the Project view

The Project view is divided into the following areas:

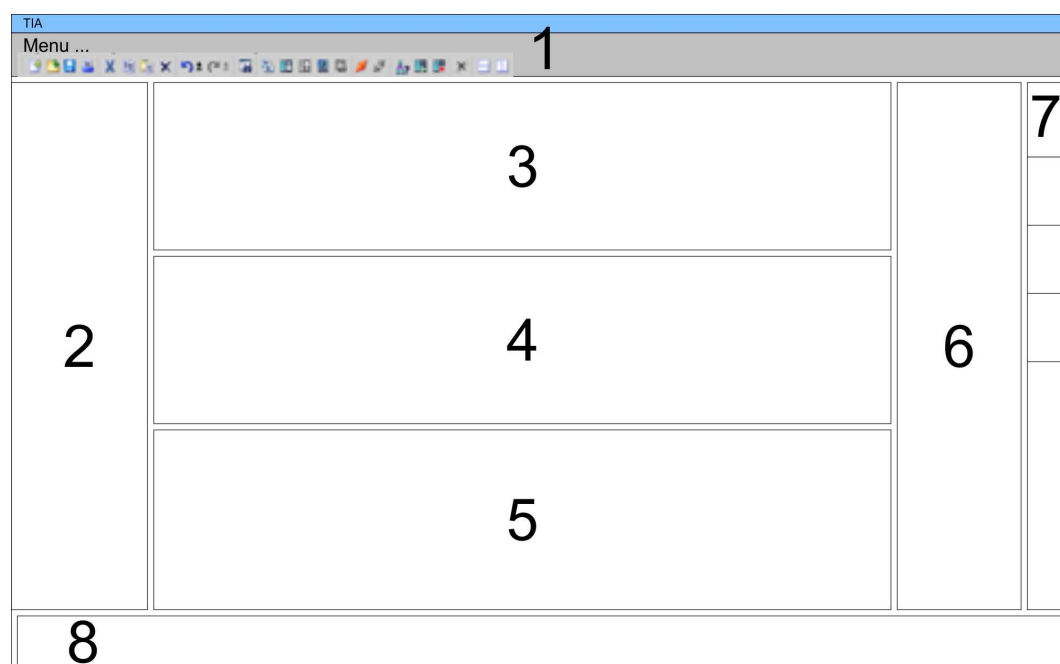

- 1 Menu bar with toolbars
- 2 Project tree with Details view
- 3 Project area
- 4 Device overview of the project respectively area for block programming
- 5 Properties dialog of a device (parameter) respectively information area
- 6 Hardware catalog and tools
- 7 "Task-Cards" to select hardware catalog, tasks and libraries
- 8 Jump to Portal or Project view

11.2 TIA Portal - Hardware configuration - CPU

Overview

The hardware configuration of the CPU happens in the Siemens TIA Portal by means of a virtual PROFINET IO device. For the PROFINET interface is standardized software sided, the functionality is guaranteed by including a GSDML file into the Siemens TIA Portal.

The hardware configuration of the CPU is divided into the following parts:

- Installation GSDML *'VIPA MICRO PLC'* for PROFINET
- Configuration Siemens CPU
- Connection *'VIPA MICRO PLC'* as PROFINET IO device

Installation GSDML CPU for PROFINET

The installation of the PROFINET IO devices 'VIPA MICRO PLC' happens in the hardware catalog with the following approach:

1. ➤ Go to the service area of www.vipa.com.
2. ➤ Load from the download area at 'Config files ➔ PROFINET' the according file for your System MICRO.
3. ➤ Extract the file into your working directory.
4. ➤ Start the Siemens TIA Portal.
5. ➤ Close all the projects.
6. ➤ Switch to the *Project view*.
7. ➤ Select 'Options ➔ Install general station description file (GSD)'.
8. ➤ Navigate to your working directory and install the according GSDML file.

⇒ After the installation the hardware catalog is refreshed and the Siemens TIA Portal is finished.

After restarting the Siemens TIA Portal the according PROFINET IO device can be found at *Other field devices > PROFINET > IO > VIPA GmbH > VIPA Micro System*.



Thus, the VIPA components can be displayed, you have to deactivate the "Filter" of the hardware catalog.

Configuration CPU

With the Siemens TIA Portal, the CPU from VIPA is to be configured as CPU 314C-2 PN/DP (314-6EH04-0AB0 V3.3) from Siemens.

1. ➤ Start the Siemens TIA Portal.
2. ➤ Create a new project in the *Portal view* with 'Create new project'.
3. ➤ Switch to the *Project view*.
4. ➤ Click in the *Project tree* at 'Add new device'.
5. ➤ Select the following CPU in the input dialog:

SIMATIC S7-300 > CPU 314C-2 PN/DP (314-6EH04-0AB0 V3.3)

⇒ The CPU is inserted with a profile rail.

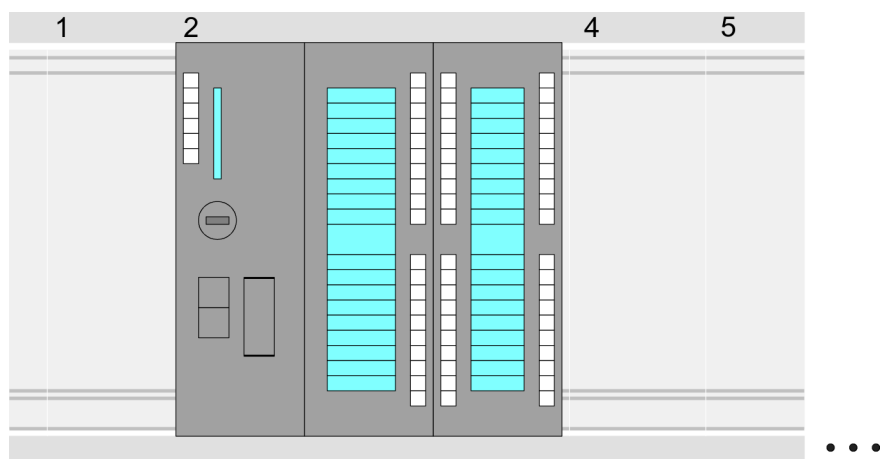

Device overview:

Module	...	Slot	...	Type	...
PLC ...		2		CPU 314C-2PN/DP	
MPI interface...		2 X1		MPI/DP interface	
PROFINET inter- face		2 X2		PROFINET interface	
DI24/DO16		2 5		DI24/DO16	
AI5/AO2...		2 6		AI5/AO2	
Counter...		2 7		Counter	
...					



- For parametrization of the digital I/O periphery and the technological functions the corresponding sub modules of the CPU 314C-2 PN/DP (314-6EH04-0AB0 V3.3) is to be used.
- The controlling of the operating modes of the technological functions happens by means of handling blocks of the user program.

Setting standard CPU parameters

Since the CPU from VIPA is configured as Siemens CPU, so the setting of the non- VIPA specific parameters takes place via the Siemens CPU. For parametrization click in the *Project area* respectively in the *Device overview* at the CPU part. Then the parameters of the CPU part are shown in the *Properties dialog*. Here you can make your parameter settings. ↪ *Chap. 4.7 'Setting standard CPU parameters' page 76*

Connection CPU as PROFINET IO device

1. ➤ Switch in the *Project area* to '*Network view*'.
2. ➤ After installing the GSDML the IO device for the CPU may be found in the hardware catalog at *Other field devices > PROFINET > IO > VIPA GmbH > VIPA MICRO PLC*. Connect the slave system to the CPU by dragging&dropping it from the hardware catalog to the *Network view* and connecting it via PROFINET to the CPU.
3. ➤ Click in the *Network view* at the PROFINET part of the Siemens CPU and enter at valid IP address data in '*Properties*' at '*Ethernet address*' in the area '*IP protocol*'.
4. ➤ Enter at '*PROFINET*' a '*PROFINET device name*'. The device name must be unique at the Ethernet subnet.

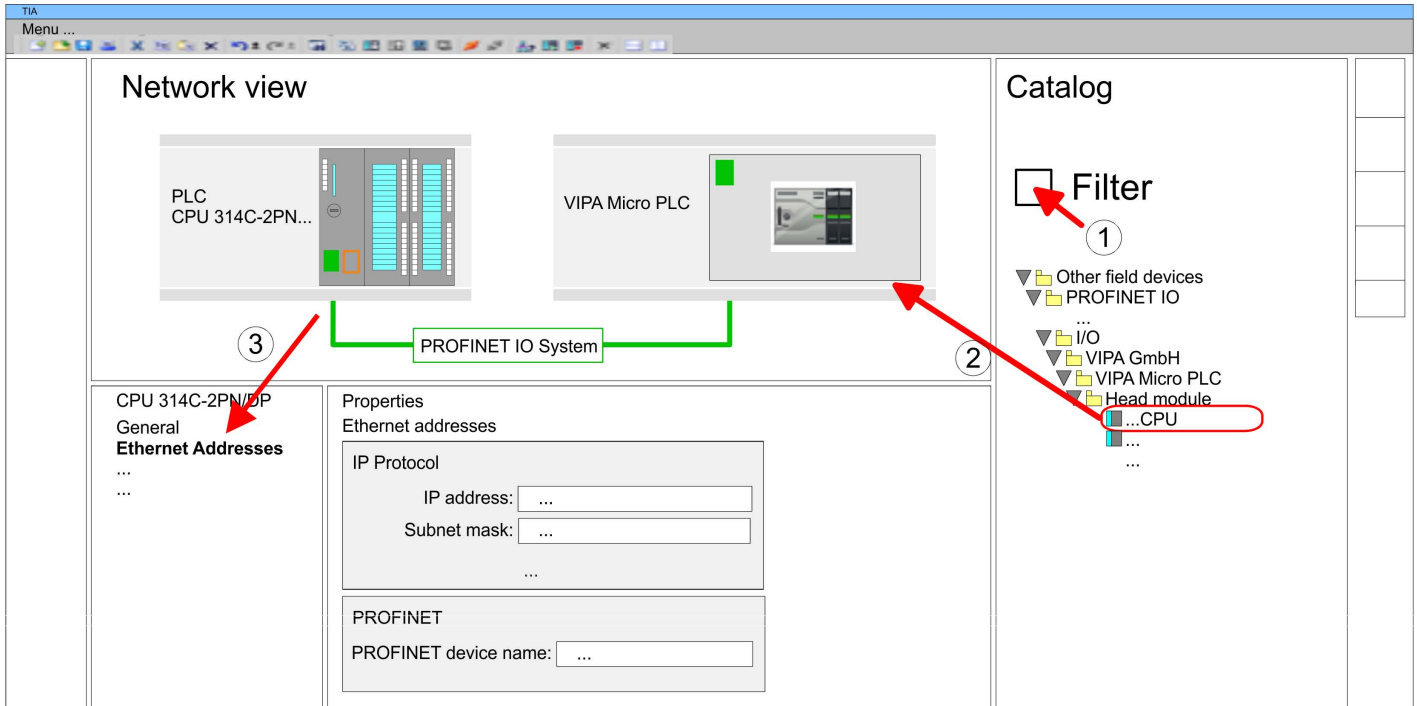

5. ➤ Select in the *Network view* the IO device 'VIPA MICRO PLC' and switch to the *Device overview*.
 - ⇒ In the *Device overview* of the PROFINET IO device 'VIPA MICRO PLC' the CPU is already placed at slot 0. From slot 1 you can place your Extension module.

Setting VIPA specific CPU parameters

For parametrization click at the CPU at slot 0 in the *Device overview* of the PROFINET IO device 'VIPA MICRO PLC'. Then the parameters of the CPU part are shown in the *Properties dialog*. Here you can make your parameter settings. ↪ *Chap. 4.8 'Setting VIPA specific CPU parameters' page 80*

11.3 TIA Portal - Hardware configuration - Ethernet PG/OP channel

Overview

The CPU has an integrated Ethernet PG/OP channel. This channel allows you to program and remote control your CPU.

- The Ethernet PG/OP channel (X3/X4) is designed as switch. This enables PG/OP communication via the connections X3 and X4.
- Configurable connections are possible.
- DHCP respectively the assignment of the network configuration with a DHCP server is supported.
- Default diagnostics addresses: 2025 ... 2040
- At the first commissioning respectively after a factory reset the Ethernet PG/OP channel has no IP address. For online access to the CPU via the Ethernet PG/OP channel, valid IP address parameters have to be assigned to this by means of your configuration tool. This is called "initialization".
- Via the Ethernet PG/OP channel, you have access to:
 - Device website, where you can find information on firmware status, connected peripherals, current cycle times, etc.
 - *WebVisu* project, which is to be created in the *SPEED7 Studio*.
 - PROFINET IO controller or the PROFINET I-Device.

Assembly and commissioning

1. ➤ Install your System MICRO with your CPU.
2. ➤ Wire the system by connecting cables for voltage supply and signals.
3. ➤ Connect the one of the Ethernet jacks (X3, X4) of the Ethernet PG/OP channel to Ethernet.
4. ➤ Switch on the power supply.
 - ⇒ After a short boot time the CP is ready for communication. He possibly has no IP address data and requires an initialization.

"Initialization" via Online functions

The initialization via the Online functions takes place with the following proceeding:

- Determine the current Ethernet (MAC) address of your Ethernet PG/OP channel. This can be found at the front of the CPU labelled as "MAC PG/OP: ...".

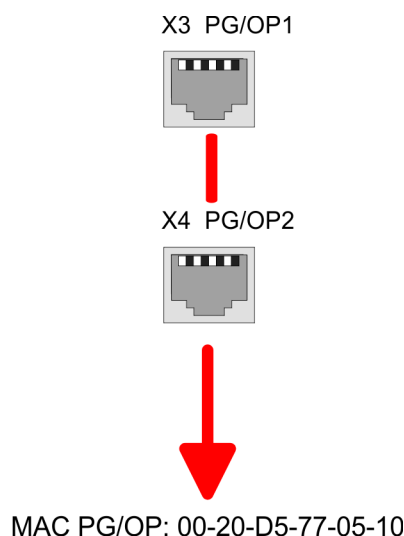

Assign IP address parameters

You get valid IP address parameters from your system administrator. The assignment of the IP address data happens online in the Siemens TIA Portal with the following proceeding:

1. Start the Siemens TIA Portal.
2. Switch to the 'Project view'.
3. Click in the 'Project tree' at 'Online access' and choose here by a doubleclick your network card, which is connected to the Ethernet PG/OP channel.
4. To get the stations and their MAC address, use the 'Accessible device'. This can be found at the front of the CPU labelled as "MAC PG/OP: ...".
5. Choose from the list the module with the known MAC address (Onboard PG/OP [MAC address]) and open with "Online & Diagnostics" the diagnostics dialog in the Project area.
6. Navigate to *Functions > Assign IP address*. Type in the IP configuration like IP address, subnet mask and gateway.
7. Confirm with [Assign IP configuration].
 - ⇒ Directly after the assignment the Ethernet PG/OP channel is online reachable using the set IP address data. The value remains as long as it is reassigned, it is overwritten by a hardware configuration or an factory reset is executed.

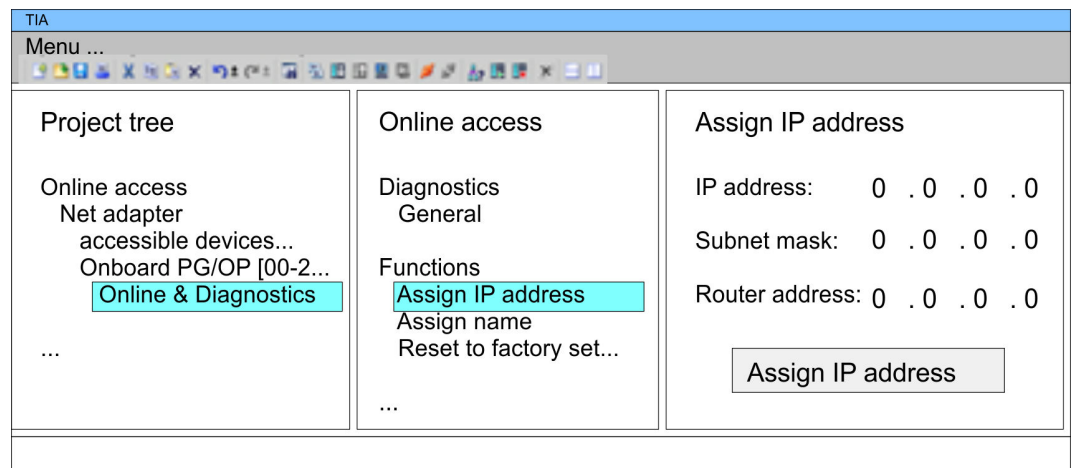

i Due to the system you may get a message that the IP address could not be assigned. This message can be ignored.

11.3.1 Take IP address parameters in project

2 variants for configuration

From firmware version V. 2.4. and up, you have the following options for configuring the Ethernet PG/OP channel:

- Configuration via integrated CPU interface (firmware version V. 2.4. and up only).
- Configuration via additional CP (all firmware versions).

11.3.1.1 Configuration via integrated CPU interface

Proceeding

From firmware version V. 2.4. this variant for configuration is recommended. The following advantages result:

- The configuration becomes clearer, because the periphery modules and the PROFINET IO devices are configured on the PROFINET line of the CPU and no additional CP is to be configured.
- There are no address collisions, because the S7 addresses for all components are assigned from the address area of the CPU.

Unless during the hardware configuration of the CPU  259 there was no IP address data assigned yet or these are to be changed, the configuration happens to the following proceeding, otherwise the Ethernet PG/OP channel is configured.

1. ➤ Open the Siemens TIA Portal and, if not already done, configure the Siemens CPU 314C-2 PN/DP (314-6EH04-0AB0 V3.3).
2. ➤ Click in the *Network view* at the PROFINET part of the Siemens CPU and enter the previous assigned IP address data and subnet in 'Properties' at 'Ethernet address' in the area 'IP protocol'. The IP address data are not accepted without subnet assignment!
3. ➤ Transfer your project.

11.3.1.1.1 Time-of-day synchronization

NTP method

In the NTP mode (**N**etwork **T**ime **P**rotocol) the module sends as client time-of-day queries at regular intervals to all configured NTP servers within the sub net. You can define up to 4 NTP server. Based on the response from the servers, the most reliable and most exact time-of-day is determined. Here the time with the lowest *stratum* is used. *Stratum 0* is the time standard (atomic clock). *Stratum 1* are directly linked to this NTP server. Using the NTP method, clocks can be synchronized over subnet boundaries. The configuration of the NTP servers is carried out in the Siemens SIMATIC Manager via the CP, which is already configured.

1. ➤ In the 'Device configuration', click at 'PROFINET interface' of the Siemens CPU and open the 'Properties' dialog.
2. ➤ In the 'Properties', select 'Time-of-day synchronization'.
3. ➤ Enable the NTP method.
4. ➤ Add the appropriate NTP servers by specifying their IP addresses.
5. ➤ Set the 'Update interval' you want. Within this interval, the time of the module is synchronized once.
6. ➤ Save and transfer your project to the CPU.
 - ⇒ After transmission, the NTP time is requested by each configured time server and the best response for the time synchronization is used.



Please note that although the time zone is evaluated, an automatic changeover from winter to summer time is not supported. Industrial systems with time-of-day synchronization should always be set in accordance to the winter time.

With the FC 61 you can determine the local time in the CPU. More information about the usage of this block may be found in the manual "SPEED7 Operation List" from VIPA.

11.3.1.2 Configuration via additional CP

Proceeding

This is the conventional variant for configuration and is supported by all firmware versions. If possible, always use the configuration via the internal interface, otherwise the following disadvantages result:

- Address overlaps are not recognized in the Siemens TIA Portal.
- For PROFINET devices only the address range 0 ... 1023 is available.
- The addresses of the PROFINET devices are not checked with the address space of the CPU from the Siemens TIA portal for address overlaps.

The configuration happens according to the following procedure:

1. ➤ Open your project.
2. ➤ If not already done, configure in the 'Device configuration' a Siemens CPU 314C-2 PN/DP (314-6EH04-0AB0 V3.3).
3. ➤ As Ethernet PG/OP channel place at slot 4 the Siemens CP 343-1 (6GK7 343-1EX30 0XE0 V3.0).



CAUTION!

Please configure the diagnostic addresses of the CP343-1EX30 for 'PN-IO', 'Port1' and 'Port2' so that no overlaps occur in the periphery input area. Otherwise your CPU can not start-up and you receive the diagnostic entry 0xE904. Address overlaps are not recognized in the Siemens TIA Portal.

4. ➤ Open the 'Property' dialog by clicking on the CP 343-1EX30 and enter for the CP at 'Properties' at 'Ethernet address' the IP address data and subnet, which you have assigned before. The IP address data are not accepted without subnet assignment!
5. ➤ Transfer your project.

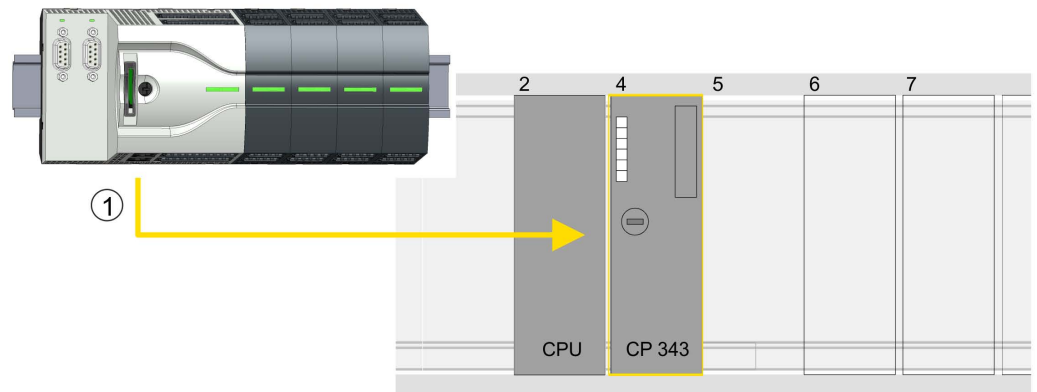

1 Ethernet PG/OP channel

Device overview









Module	...	Slot	...	Type	...
PLC ...		2		CPU 314C-2 PN/DP	
MPI/DP interface		2 X1		MPI/DP interface	
PROFINET interface		2 X2		PROFINET interface	
...		

CP 343-1		4		CP 343-1	
...		

11.3.1.2.1 Time-of-day synchronization

NTP method

In the NTP mode (**N**etwork **T**ime **P**rotocol) the module sends as client time-of-day queries at regular intervals to all configured NTP servers within the sub net. You can define up to 4 NTP server. Based on the response from the servers, the most reliable and most exact time-of-day is determined. Here the time with the lowest *stratum* is used. *Stratum 0* is the time standard (atomic clock). *Stratum 1* are directly linked to this NTP server. Using the NTP method, clocks can be synchronized over subnet boundaries. The configuration of the NTP servers is carried out in the Siemens SIMATIC Manager via the CP, which is already configured.

1.  In the 'Device configuration', click the CP 343-1EX30.
2.  Click on 'PROFINET interface' in the 'Device overview'.
3.  In the 'Properties', select 'Time-of-day synchronization'.
4.  Enable the NTP method by enabling 'Activate time-of-day synchronization' and selecting 'NTP' at 'Method'.
5.  Add the appropriate NTP servers by specifying their IP addresses.
6.  Select your 'Time zone'. In the NTP method, UTC (**U**niversal **T**ime **C**oordinated) is generally transmitted; this corresponds to GMT (Greenwich Mean Time). By configuring the local time zone, you can set a time offset to UTC.
7.  Set the 'Update interval' you want. Within this interval, the time of the module is synchronized once.
8.  Save and transfer your project to the CPU.
 - ⇒ After transmission, the NTP time is requested by each configured time server and the best response for the time synchronization is used.



Please note that although the time zone is evaluated, an automatic changeover from winter to summer time is not supported. Industrial systems with time-of-day synchronization should always be set in accordance to the winter time.

With the FC 61 you can determine the local time in the CPU. More information about the usage of this block may be found in the manual "SPEED7 Operation List" from VIPA.

11.4 TIA Portal - VIPA-Include library

Overview

- The VIPA specific blocks can be found in the "Service" area of www.vipa.com as library download file at *Downloads > VIPA LIB*.
- The library is available as packed zip file for the corresponding TIA Portal version.
- As soon as you want to use VIPA specific blocks you have to import them into your project.
Execute the following steps:
 - Load and unzip the file ...TIA_Vxx.zip (note TIA Portal version)
 - Open library and transfer blocks into the project

Unzip ...TIA_Vxx.zip

Start your un-zip application with a double click on the file TIA_Vxx.zip and copy all the files and folders in a work directory for the Siemens TIA Portal.

Open library and transfer blocks into the project

1. Start the Siemens TIA Portal with your project.
2. Switch to the *Project view*.
3. Choose "Libraries" from the task cards on the right side.
4. Click at "Global libraries".
5. Click at "Open global libraries".
6. Navigate to your directory and load the file ...TIA.alxx.

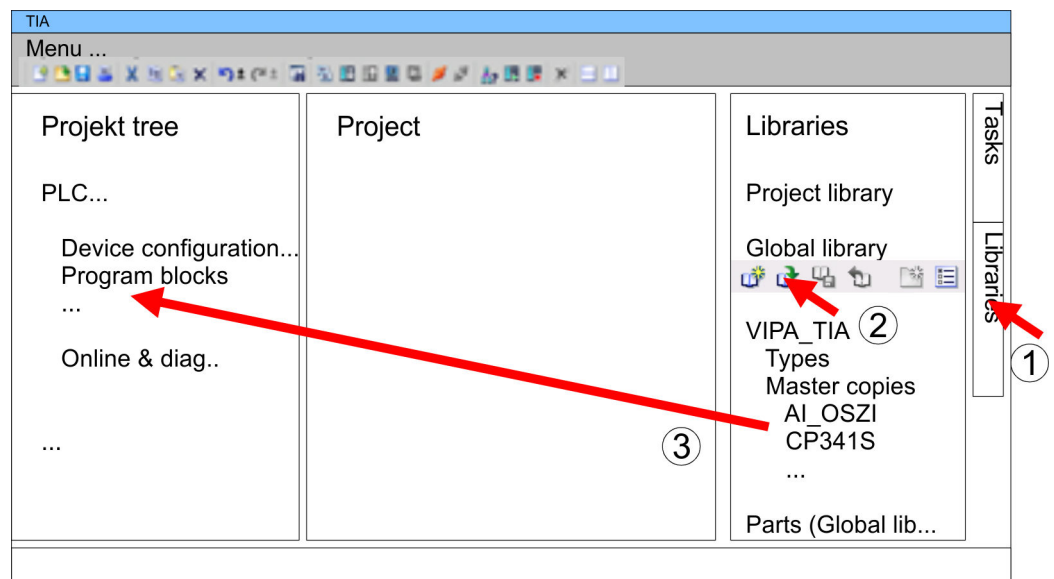

7. Copy the necessary blocks from the library into the "Program blocks" of the *Project tree* of your project. Now you have access to the VIPA specific blocks via your user application.

11.5 TIA Portal - Project transfer

Overview

There are the following possibilities for project transfer into the CPU:

- Transfer via Ethernet
- Transfer via memory card
- Option: Transfer via MPI

11.5.1 Transfer via Ethernet

Transfer via Ethernet

For transfer via Ethernet the CPU has the following interface:

- X3/X4: Ethernet PG/OP channel via an integrated 2-port switch

Initialization

So that you may the according Ethernet interface, you have to assign IP address parameters by means of the "initialization". ↪ *Chap. 11.3 'TIA Portal - Hardware configuration - Ethernet PG/OP channel' page 263*

Please consider to use the same IP address data in your project for the CP 343-1.

Transfer

1. ➤ For the transfer, connect, if not already done, the appropriate Ethernet jack to your Ethernet.
2. ➤ Open your project with the Siemens TIA Portal.
3. ➤ Click in the *Project tree* at *Online access* and choose here by a double-click your network card, which is connected to the Ethernet PG/OP interface.
4. ➤ Select in the *Project tree* your CPU and click at [Go online].
5. ➤ Set the access path by selecting "PN/IE" as type of interface, your network card and the according subnet. Then a net scan is established and the corresponding station is listed.
6. ➤ Establish with [Connect] a connection.
7. ➤ Click to '*Online → Download to device*'.
 - ⇒ The according block is compiled and by a request transferred to the target device. Provided that no new hardware configuration is transferred to the CPU, the entered Ethernet connection is permanently stored in the project as transfer channel.



11.5.2 Transfer via memory card

Proceeding

The memory card serves as external storage medium. There may be stored several projects and sub-directories on a memory card. Please regard that your current project is stored in the root directory and has one of the following file names:

- S7PROG.WLD
- AUTOLOAD.WLD

1. ➤ Start the Siemens TIA Portal with your project.
2. ➤ Create a wld file with '*Project → Memory card file → New*'.
 - ⇒ The wld file is shown in the *Project tree* at "SIMATIC Card Reader" as "Memory card file".
3. ➤ Copy the blocks from the *Program blocks* to the wld file. Here the hardware configuration data are automatically copied to the wld file as "System data".

4. ➔ Copy the wld file at a suited memory card. Plug this into your CPU and start it again.
 - ⇒ The transfer of the application program from the memory card into the CPU takes place depending on the file name after an overall reset or PowerON.
 - S7PROG.WLD* is read from the memory card after overall reset.
 - AUTOLOAD.WLD* is read from the memory card after PowerON.
 - The flickering of the yellow LED  of the status bar of the CPU marks the active transfer. Please regard that your user memory serves for enough space for your user program, otherwise your user program is not completely loaded and the red LED  of the status bar lights up.

11.5.3 Option: Transfer via MPI

General

For the transfer via MPI the use of the optionally available extension module EM M09 is required. The extension module provides the interface X2: MPI(PB) with fixed pin assignment. ↪ *Chap. 2.4 'Mounting' page 14*

Net structure

The structure of a MPI net is electrically identical with the structure of a PROFIBUS net. This means the same rules are valid and you use the same components for the build-up. The single participants are connected with each other via bus interface plugs and PROFIBUS cables. Per default the MPI net runs with 187.5kbaud. VIPA CPUs are delivered with MPI address 2.

Terminating resistor

A cable has to be terminated with its surge impedance. For this you switch on the terminating resistor at the first and the last participant of a network or a segment. Please make sure that the participants with the activated terminating resistors are always power supplied. Otherwise it may cause interferences on the bus.

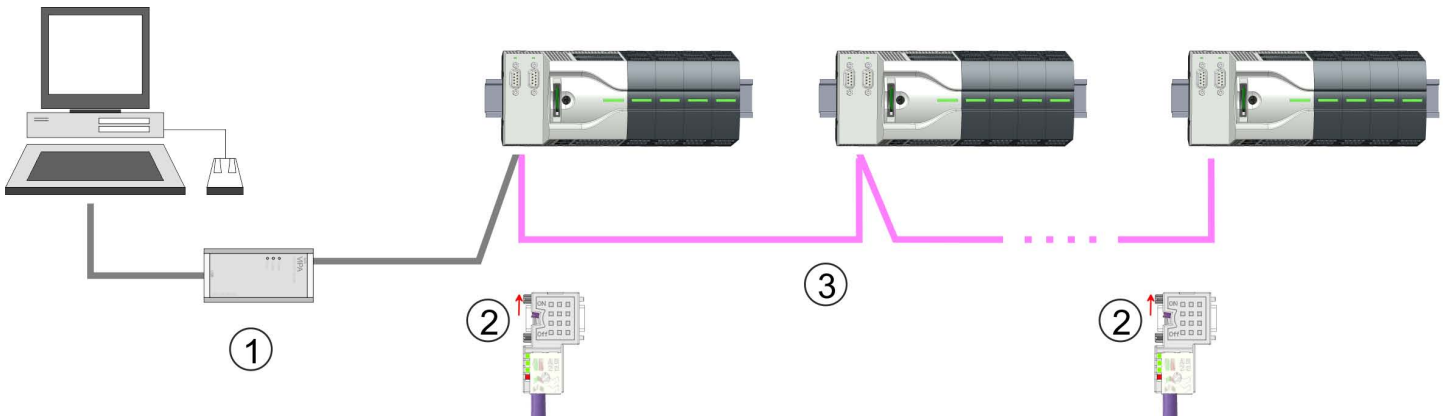

- 1 MPI programming cable
- 2 Activate the terminating resistor via switch
- 3 MPI network

Proceeding enabling the interface

A hardware configuration to enable the MPI interface is not necessary. By installing the extension module EM M09 the MPI interface is enabled.

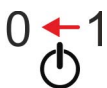

1. ➔ Turn off the power supply.

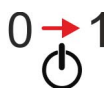
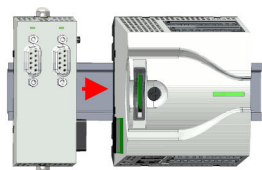

2. ➤ Mount the extension module. ↪ *Chap. 2.4 'Mounting' page 14*

3. ➤ Switch on the power supply.

⇒ After a short boot time the interface X2 MPI(PB) is ready for MPI communication with the MPI address 2.

Proceeding transfer via MPI interface

Currently the VIPA programming cables for transfer via MPI are not supported. This is only possible with the programming cable from Siemens. The cables provide a RS232 res. USB plug for the PC and a bus enabled RS485 plug for the CPU. Due to the RS485 connection you may plug the MPI programming cables directly to an already plugged plug on the RS485 jack. Every bus participant identifies itself at the bus with a unique address, in the course of the address 0 is reserved for programming devices.

1. ➤ Establish a connection to your extension module via MPI with an appropriate programming cable. Information may be found in the corresponding documentation of the programming cable.
2. ➤ Start the Siemens TIA Portal with your project.
3. ➤ Select in the *Project tree* your CPU and choose '*Context menu* → *Download to device* → *Hardware configuration*' to transfer the hardware configuration.
4. ➤ To transfer the PLC program choose '*Context menu* → *Download to device* → *Software*'. Due to the system you have to transfer hardware configuration and PLC program separately.

Appendix

Content

A	System specific event IDs	274
B	Integrated blocks	322
C	SSL partial list	325

A System specific event IDs

Event IDs

↪ Chap. 4.19 'Diagnostic entries' page 105

Event ID	Description
0x115C	Manufacture interrupt for EtherCAT / PROFINET IO
	OB: OB number
	ZINFO1: Logical address of the slave station that triggered the interrupt
	ZINFO2: Interrupt type
	0: Reserved
	1: Diagnostic interrupt (incoming)
	2: Process interrupt
	3: Pull interrupt
	4: Plug interrupt
	5: Status interrupt
	6: Update interrupt
	7: Redundancy interrupt
	8: Controlled by the supervisor
	9: Enabled
	10: Wrong sub module plugged
	11: Recurrence of the sub module
	12: Diagnostic interrupt (outgoing)
	13: Cross traffic connection message
	14: Neighbourhood change message
	15: Synchronisation message (bus)
	16: Synchronisation message (device)
	17: Network component message
	18: Clock synchronisation message (bus)
	31: Pull interrupt component
32: Vendor-specific interrupt min.	
33: Vendor-specific interrupt topology change	
127: Vendor-specific interrupt max.	
ZINFO3: CoE error code	
0xE003	Error in access to periphery
	ZINFO1: Transfer type
	ZINFO2: Periphery address
	ZINFO3: Slot
0xE004	Multiple configuration of a periphery address
	ZINFO1: Periphery address
	ZINFO2: Slot

Event ID	Description
0xE005	Internal error - Please contact the hotline!
	ZINFO1: Not user relevant
	ZINFO2: Not user relevant
	ZINFO3: Not user relevant
0xE007	Configured input/output bytes do not fit in the periphery area
0xE008	Internal error - Please contact the hotline!
0xE009	Error on accessing the standard backplane bus
0xE010	Non-defined component recognised at the standard backplane bus
	ZINFO2: Slot
	ZINFO3: Type identifier
0xE011	Master project engineering at slave CPU not possible or wrong slave configuration
0xE012	Error at configuration standard backplane bus
0xE013	Error at shift register access to standard backplane bus digital modules
0xE014	Error in Check_Sys
0xE015	Error in access to master
	ZINFO2: Slot of the master
	ZINFO2: Page frame master
0xE016	Maximum block size exceeded in master transfer
	ZINFO1: Periphery address
	ZINFO2: Slot
0xE017	Error in access to integrated slave
0xE018	Error in mapping the master periphery
0xE019	Error on standard backplane bus system detection
0xE01A	Error at detection of the operating mode (8/9 bit)
0xE01B	Error: Maximum number of plug-in components exceeded
0xE020	Error: Interrupt information undefined
	ZINFO2: Slot
	ZINFO3: Not user relevant
	DatID: Interrupt type
0xE030	Error of the standard backplane bus
0xE033	Internal error - Please contact the hotline!
0xE0B0	SPEED7 is not stoppable
	ZINFO1: Not user relevant
	ZINFO2: Not user relevant
	ZINFO3: Not user relevant
	DatID: Not user relevant
0xE0C0	Not enough memory space in the working memory for code block (block too large)
0xE0CB	Error on SSL access

Event ID	Description
	ZINFO1: Error
	4: SSL wrong
	5: Sub-SSL wrong
	6: Index wrong
	ZINFO2: SZL-ID
	ZINFO3: Index
0xE0CC	Communication error
	ZINFO1: Error code
	1: Wrong priority
	2: Buffer overrun
	3: Telegram format error
	4: Wrong SSL request (SSL-ID invalid)
	5: Wrong SSL request (SSL-Sub-ID invalid)
	6: Wrong SSL request (SSL-Index invalid)
	7: Wrong value
	8: Wrong return value
	9: Wrong SAP
	10: Wrong connection type
	11: Wrong sequence number
	12: Faulty block number in the telegram
	13: Faulty block type in the telegram
	14: Inactive function
	15: Wrong size in the telegram
	20: Error in writing on MMC
	90: Faulty buffer size
	98: Unknown error
	99: Internal error
0xE0CD	Error at DP-V1 job management
	ZINFO1: Not user relevant
	ZINFO2: Not user relevant
	ZINFO3: Not user relevant
	DatID: Not user relevant
0xE0CE	Error: Time out when sending i-slave diagnostics
0xE100	Memory card access error
0xE101	Memory card error file system
0xE102	Memory card error FAT
0xE104	Memory card error at saving
	ZINFO3: Not user relevant

Event ID	Description
0xE200	Memory card writing finished (Copy Ram2Rom)
	OB: Not user relevant
	PK: Not user relevant
0xE210	Memory card reading finished (reload after memory reset)
	OB: Not user relevant
	PK: Not user relevant
	ZINFO1 - Position 0: Not user relevant
0xE21D	Memory card reading: Error on reload (after memory reset), error in the block header
	ZINFO1: Block type
	56: OB
	65: DB
	66: SDB
	67: FC
	68: SFC
	69: FB
	70: SFB
	97: VDB
	98: VSDB
	99: VFC
	100: VSFC
	101: VFB
	102: VSFB
	111: VOB
	ZINFO2: Block number
ZINFO3: Block length	
0xE21E	Memory card reading: Error in recharging (after memory reset), "Protect.wld" file too large
	OB: Not user relevant
0xE21F	Memory card reading: Error at reload (after memory reset), checksum error when reading
	OB: Not user relevant
	PK: Not user relevant
	ZINFO1: Not user relevant
	ZINFO2: Block type
	56: OB
	65: DB
	66: SDB
	67: FC
	68: SFC
	69: FB

Event ID	Description
	70: SFB
	97: VDB
	98: VSDB
	99: VFC
	100: VSFC
	101: VFB
	102: VSFB
	111: VOB
	ZINFO3: Block number
0xE300	Internal flash writing completed (copy Ram2Rom)
0xE310	Internal flash reading completed (recharging after battery failure)
0xE400	FSC card was plugged
	OB: FSC activated from this slot (PK)
	OB: The inserted FSC is the activated FSC
	OB: The inserted FSC is compatible with the CPU
	PK: FSC source
	0: CPU
	1: Card
	ZINFO1: FSC(CRC)
	1146: 955-C000070
	1736: 955-C0NE040
	2568: FSC-C0ME040
	3450: 955-C000M30
	3903: 955-C000S30
	4361: FSC-C000M30
	4940: FSC-C000S30
	5755: 955-C0ME040
	6843: FSC-C0NE040
	8561: FSC-C000S20
	9012: FSC-C000M20
	13895: 955-C000060
	15618: 955-C000S20
	16199: 955-C000M20
	17675: FSC-C000S00
	18254: FSC-C000M00
	20046: FSC-C000040
	21053: 955-C000040
	22904: 955-C000S00

Event ID	Description
	23357: 955-C000M00
	24576: 955-C000050
	35025: 955-C00MC10
	36351: FSC-C000S40
	36794: FSC-C000M40
	37260: 955-C000S40
	37833: 955-C000M40
	38050: FSC-C00MC10
	41460: 955-C000M50
	41526: 955-C0PE040
	42655: FSC-C00MC00
	47852: 955-C00MC00
	48709: FSC-C0PE040
	50574: 955-C000M70
	52366: 955-C000030
	53501: FSC-C000030
	58048: FSC-C000020
	63411: 955-C000M60
	65203: 955-C000020
	ZINFO2: FSC serial number (high word)
	ZINFO3: FSC serial number (low word)
0xE401	FSC card was removed
	OB: Action after the end of the trial time
	0: No action
	1: CPU STOP
	2: CPU STOP and FSC deactivated
	3: Factory reset
	255: FSC was not activated
	PK: FSC source
	0: CPU
	1: Card
	ZINFO1: FSC(CRC)
	1146: 955-C000070
	1736: 955-C0NE040
	2568: FSC-C0ME040
	3450: 955-C000M30
	3903: 955-C000S30
	4361: FSC-C000M30

Event ID	Description
	4940: FSC-C000S30
	5755: 955-C0ME040
	6843: FSC-C0NE040
	8561: FSC-C000S20
	9012: FSC-C000M20
	13895: 955-C000060
	15618: 955-C000S20
	16199: 955-C000M20
	17675: FSC-C000S00
	18254: FSC-C000M00
	20046: FSC-C000040
	21053: 955-C000040
	22904: 955-C000S00
	23357: 955-C000M00
	24576: 955-C000050
	35025: 955-C00MC10
	36351: FSC-C000S40
	36794: FSC-C000M40
	37260: 955-C000S40
	37833: 955-C000M40
	38050: FSC-C00MC10
	41460: 955-C000M50
	41526: 955-C0PE040
	42655: FSC-C00MC00
	47852: 955-C00MC00
	48709: FSC-C0PE040
	50574: 955-C000M70
	52366: 955-C000030
	53501: FSC-C000030
	58048: FSC-C000020
	63411: 955-C000M60
	65203: 955-C000020
	ZINFO2: FSC serial number (high word)
	ZINFO3: FSC serial number (low word)
	DatID: FeatureSet Trialtime in minutes
0xE402	A configured functionality is not activated. The configuration is accepted, but the PLC can not go to RUN.
	ZINFO1: Required FSC: PROFIBUS
	ZINFO1: Required FSC: MOTION

Event ID	Description
	ZINFO2: Number of released axes
	ZINFO3: Number of configured axes
0xE403	FSC can not be activated in this CPU
	OB: FCS error code
	PK: FSC source
	0: CPU
	1: Card
	ZINFO1: FSC(CRC)
	1146: 955-C000070
	1736: 955-C0NE040
	2568: FSC-C0ME040
	3450: 955-C000M30
	3903: 955-C000S30
	4361: FSC-C000M30
	4940: FSC-C000S30
	5755: 955-C0ME040
	6843: FSC-C0NE040
	8561: FSC-C000S20
	9012: FSC-C000M20
	13895: 955-C000060
	15618: 955-C000S20
	16199: 955-C000M20
	17675: FSC-C000S00
	18254: FSC-C000M00
	20046: FSC-C000040
	21053: 955-C000040
	22904: 955-C000S00
	23357: 955-C000M00
	24576: 955-C000050
	35025: 955-C00MC10
	36351: FSC-C000S40
	36794: FSC-C000M40
	37260: 955-C000S40
	37833: 955-C000M40
	38050: FSC-C00MC10
	41460: 955-C000M50
	41526: 955-C0PE040
	42655: FSC-C00MC00

Event ID	Description
	47852: 955-C00MC00
	48709: FSC-C0PE040
	50574: 955-C000M70
	52366: 955-C000030
	53501: FSC-C000030
	58048: FSC-C000020
	63411: 955-C000M60
	65203: 955-C000020
	ZINFO2: FSC serial number (high word)
	ZINFO3: FSC serial number (low word)
0xE404	Feature set deleted due to CRC error
0xE405	The trial time of a feature set/memory card has expired
	OB: Action after the end of the trial time
	0: No action
	1: CPU STOP
	2: CPU STOP and FSC deactivated
	3: Factory reset
	255: FSC was not activated
	PK: FSC source
	0: CPU
	1: Card
	ZINFO1: FSC(CRC)
	1146: 955-C000070
	1736: 955-C0NE040
	2568: FSC-C0ME040
	3450: 955-C000M30
	3903: 955-C000S30
	4361: FSC-C000M30
	4940: FSC-C000S30
	5755: 955-C0ME040
	6843: FSC-C0NE040
	8561: FSC-C000S20
	9012: FSC-C000M20
	13895: 955-C000060
	15618: 955-C000S20
	16199: 955-C000M20
	17675: FSC-C000S00
	18254: FSC-C000M00

Event ID	Description
	20046: FSC-C000040
	21053: 955-C000040
	22904: 955-C000S00
	23357: 955-C000M00
	24576: 955-C000050
	35025: 955-C00MC10
	36351: FSC-C000S40
	36794: FSC-C000M40
	37260: 955-C000S40
	37833: 955-C000M40
	38050: FSC-C00MC10
	41460: 955-C000M50
	41526: 955-C0PE040
	42655: FSC-C00MC00
	47852: 955-C00MC00
	48709: FSC-C0PE040
	50574: 955-C000M70
	52366: 955-C000030
	53501: FSC-C000030
	58048: FSC-C000020
	63411: 955-C000M60
	65203: 955-C000020
	ZINFO2: FSC serial number (high word)
	ZINFO3: FSC serial number (low word)
	DatID: FeatureSet Trialtime in minutes
0xE406	The inserted feature set is corrupt
	PK: FSC source
	0: CPU
	1: Card
0xE410	A CPU feature set was activated
	PK: FSC source
	0: CPU
	1: Card
	ZINFO1: FSC(CRC)
	1146: 955-C000070
	1736: 955-C0NE040
	2568: FSC-C0ME040
	3450: 955-C000M30

Event ID	Description
	3903: 955-C000S30
	4361: FSC-C000M30
	4940: FSC-C000S30
	5755: 955-C0ME040
	6843: FSC-C0NE040
	8561: FSC-C000S20
	9012: FSC-C000M20
	13895: 955-C000060
	15618: 955-C000S20
	16199: 955-C000M20
	17675: FSC-C000S00
	18254: FSC-C000M00
	20046: FSC-C000040
	21053: 955-C000040
	22904: 955-C000S00
	23357: 955-C000M00
	24576: 955-C000050
	35025: 955-C00MC10
	36351: FSC-C000S40
	36794: FSC-C000M40
	37260: 955-C000S40
	37833: 955-C000M40
	38050: FSC-C00MC10
	41460: 955-C000M50
	41526: 955-C0PE040
	42655: FSC-C00MC00
	47852: 955-C00MC00
	48709: FSC-C0PE040
	50574: 955-C000M70
	52366: 955-C000030
	53501: FSC-C000030
	58048: FSC-C000020
	63411: 955-C000M60
	65203: 955-C000020
	ZINFO2: FSC serial number (high word)
	ZINFO3: FSC serial number (low word)
0xE500	Memory management: Deleted block without corresponding entry in BstList
	ZINFO2: Block type

Event ID	Description
	56: OB
	65: DB
	66: SDB
	67: FC
	68: SFC
	69: FB
	70: SFB
	97: VDB
	98: VSDB
	99: VFC
	100: VSFC
	101: VFB
	102: VSFB
	111: VOB
	ZINFO3: Block number
0xE501	Parser error
	ZINFO1: Error code
	1: Parser error: SDB structure
	2: Parser error: SDB is not a valid SDB type
	ZINFO2: SDB type
	ZINFO3: SDB number
0xE502	Error in protect.wld
	ZINFO2: Block type
	56: OB
	65: DB
	66: SDB
	67: FC
	68: SFC
	69: FB
	70: SFB
	97: VDB
	98: VSDB
	99: VFC
	100: VSFC
	101: VFB
	102: VSFB
	111: VOB
	ZINFO3: Block number

Event ID	Description
0xE503	Inconsistency of code sizes and block sizes in the working memory
	ZINFO1: Code size
	ZINFO2: Block size (high word)
	ZINFO3: Block size (low word)
0xE504	Additional information for CRC error in the working memory
	ZINFO2: Block address (high word)
	ZINFO3: Block address (low word)
0xE505	Internal error - Please contact the hotline!
	ZINFO1: Cause for MemDump
	0: Unknown
	1: Manual request
	2: Invalid OP value
	3: CRC code error
	4: Processor exception
	5: Processor exception with dump after reboot
6: Block-CRC error	
0xE604	Multiple configuration of a periphery address for Ethernet PG/OP channel
	ZINFO1: Periphery address
	ZINFO3: 0: periphery address is input, 1: periphery address is output
0xE605	Too many productive connections configured
	ZINFO1: Interface slot
	ZINFO2: Number of configured connections
	ZINFO3: Number of admissible connections
0xE610	On-board PROFIBUS/MPI: Bus error removed
	PK: Not user relevant
	ZINFO1: Interface
	ZINFO2: Not user relevant
	ZINFO3: Not user relevant
	DatID: Not user relevant
0xE701	Internal error - Please contact the hotline!
	ZINFO1: Not user relevant
	ZINFO2: Not user relevant
	ZINFO3: Not user relevant
	DatID: Not user relevant
0xE703	Internal error - Please contact the hotline!
	PK: Not user relevant
	ZINFO1: Master system ID
	ZINFO2: Slave address

Event ID	Description
	ZINFO3: Not user relevant
	DatID: Not user relevant
0xE705	Too many PROFIBUS slaves configured
	ZINFO1: Diagnostic address of the PROFIBUS master
	ZINFO2: Number of configured slaves
	ZINFO3: Number of admissible slaves
0xE710	On-board PROFIBUS/MPI: Bus error occurred
	PK: Not user relevant
	ZINFO1: Interface
	ZINFO2: Not user relevant
	ZINFO3: Not user relevant
	DatID: Not user relevant
0xE720	Internal error - Please contact the hotline!
	ZINFO1: Slave no
	ZINFO2: Not user relevant
	ZINFO3: Not user relevant
	DatID: Master system ID
0xE721	Internal error - Please contact the hotline!
	ZINFO1: Not user relevant
	ZINFO2: Master system ID
	ZINFO3: Not user relevant
	DatID: Not user relevant
0xE722	Internal error - Please contact the hotline!
	ZINFO1: Channel-Event
	0: Channel offline
	1: Bus error
	2: Internal error
	ZINFO2: Master system ID
	DatID: Not user relevant
0xE723	Internal error - Please contact the hotline!
	ZINFO1: Error code
	1: Parameter error
	2: Configuration error
	ZINFO2: Master system ID
	DatID: Not user relevant
0xE780	Internal error - Please contact the hotline!
0xE781	Address range exceeds process image limit
	ZINFO1: Address

Event ID	Description
	ZINFO2: Length of the address range
	ZINFO3: Size of the process image
	DatID: Address range
0xE801	CMD - auto command: CMD_START recognized and executed
0xE802	CMD - auto command: CMD_End recognized and executed
0xE803	CMD - auto command: WAIT1SECOND recognized and executed
0xE804	CMD - auto command: WEBPAGE recognized and executed
0xE805	CMD - auto command: LOAD_PROJECT recognized and executed
0xE806	CMD - auto command: SAVE_PROJECT recognized and executed
	ZINFO3: Status
	0: Error
	1: OK
	32768: Wrong password
0xE807	CMD - auto command: FACTORY_RESET recognized and executed
0xE808	Internal error - Please contact the hotline!
	ZINFO2: Not user relevant
	ZINFO3: Not user relevant
0xE809	Internal error - Please contact the hotline!
	ZINFO3: Not user relevant
0xE80A	Internal error - Please contact the hotline!
	ZINFO3: Status
	0: OK
	65153: File create error
	65185: File writing error
	65186: Odd address for reading
0xE80B	CMD - auto command: DIAGBUF recognized and executed
	ZINFO3: Status
	0: OK
	65153: File create error
	65185: File writing error
	65186: Odd address for reading
0xE80C	Internal error - Please contact the hotline!
	ZINFO3: Status
	0: OK
	65153: File create error
	65185: File writing error
	65186: Odd address for reading
0xE80D	Internal error - Please contact the hotline!

Event ID	Description
0xE80E	CMD - auto command: SET_NETWORK recognized and executed
0xE80F	Internal error - Please contact the hotline!
	ZINFO3: Status
	0: OK
	65153: File create error
	65185: File writing error
	65186: Odd address for reading
0xE810	Internal error - Please contact the hotline!
0xE811	Internal error - Please contact the hotline!
0xE812	Internal error - Please contact the hotline!
0xE813	Internal error - Please contact the hotline!
0xE814	CMD - auto command: SET_MPI_ADDRESS identified
0xE816	CMD - auto command: SAVE_PROJECT recognized but not executed, because the CPU memory is empty
0xE817	Internal error - Please contact the hotline!
	ZINFO3: Not user relevant
0xE820	Internal message
0xE821	Internal message
0xE822	Internal message
0xE823	Internal message
0xE824	Internal message
0xE825	Internal message
0xE826	Internal message
0xE827	Internal message
0xE828	Internal message
0xE829	Internal message
0xE82A	CMD - auto command: CPUTYPE_318 recognized and executed
	ZINFO3: Error code
0xE82B	CMD - auto command: CPUTYPE_ORIGINAL recognized and executed
	ZINFO3: Error code
0xE82C	CMD - auto command: WEBVISU_PGOP_ENABLE recognized and executed
0xE82D	CMD - auto command: WEBVISU_PGOP_DISABLE recognized and executed
0xE82E	CMD - auto command: WEBVISU_CP_ENABLE recognized and executed
0xE82F	CMD - auto command: WEBVISU_CP_DISABLE recognized and executed
0xE8FB	CMD - auto command: Error: Initialization of the Ethernet PG/OP channel by means of SET_NETWORK is faulty
0xE8FC	CMD - auto command: Error: Some IP parameters missing in SET_NETWORK
0xE8FE	CMD - auto command: Error: CMD_START not found
0xE8FF	CMD - auto command: Error while reading CMD file (memory card error)

Event ID	Description
0xE901	Checksum error
	ZINFO1: Not user relevant
	ZINFO2: Not user relevant
	DatID: Not user relevant
0xE902	Internal error - Please contact the hotline!
	ZINFO1: Not user relevant
	ZINFO2: Not user relevant
	DatID: Not user relevant
0xE904	PG/OP: Multiple parametrization of a peripheral address
	ZINFO1: Peripheral address
	ZINFO2: Slot
	ZINFO3: Data width
	DatID: 0x54 Peripheral address is input address
	DatID: 0x55 Peripheral address is output address
0xE910	PG/OP: Input peripheral address out of peripheral area
	ZINFO1: Peripheral address
	ZINFO2: Slot
	ZINFO3: Data width
0xE911	PG/OP: Output peripheral address out of peripheral area
	ZINFO1: Peripheral address
	ZINFO2: Slot
	ZINFO3: Data width
0xE920	Configuration error PROFINET
	ZINFO1 - Position 0: Error code
0xE980	Error when loading the WebVisu project file
0xE981	Error in the configuration of the WebVisu project
0xE982	Internal error of the WebVisu server
0xE983	Hardware configuration of the control is not loaded, WebVisu is not started
0xE984	WebVisu is blocked by the user, start of the WebVisu was prevented
0xE985	WebVisu was started
0xE986	WebVisu was stopped
0xE987	WebVisu was enabled by the user
0xE988	WebVisu was disabled by the user
0xEA00	Internal error - Please contact the hotline!
	PK: Not relevant to user
	DatID: Not user relevant
0xEA01	Internal error - Please contact the hotline!
	PK: Not user relevant

Event ID	Description
	ZINFO1: Slot
	DatID: Not user relevant
0xEA02	SBUS: Internal error (internal plugged sub module not recognized)
	PK: Not user relevant
	ZINFO1: Slot
	ZINFO2: Type identifier target
	ZINFO3: Type identifier
	DatID: Not user relevant
0xEA03	SBUS: Communication error between CPU and IO controller
	OB: Operating mode
	0: Configuration in operating condition RUN
	1: STOP (update)
	2: STOP (memory reset)
	3: STOP (auto initialization)
	4: STOP (internal)
	5: STARTUP (cold start)
	6: STARTUP (restart/warm start)
	7: STARTUP (hot restart)
	9: RUN
	10: HALT
	11: COUPLING
	12: UPDATING
	13: DEFECTIVE
	14: Error search mode
	15: De-energised
	253: Process image release in STOP
	254: Watchdog
	255: Not set
	PK: Not user relevant
	ZINFO1: Slot
	ZINFO2: Status
	0: OK
	1: Error
	2: Empty
	3: Busy
	4: Time out
	5: Internal blocking
	6: Too many telegrams

Event ID	Description
	7: Not Connected
	8: Unknown
	DatID: Not user relevant
0xEA04	SBUS: Multiple configuration of a periphery address
	ZINFO1: Periphery address
	ZINFO2: Slot
	ZINFO3: Data width
0xEA05	Internal error - Please contact the hotline!
0xEA07	Internal error - Please contact the hotline!
0xEA08	SBUS: Configured input data width not the same as the connected input data width
	ZINFO1: Configured input data width
	ZINFO2: Slot
	ZINFO3: Input data width of the connected component
0xEA09	SBUS: Configured output data width not the same as the connected output data width
	ZINFO1: Configured output data width
	ZINFO2: Slot
	ZINFO3: Output data width of the plugged component
0xEA10	SBUS: Input periphery address outside the periphery area
	ZINFO1: Periphery address
	ZINFO2: Slot
	ZINFO3: Data width
0xEA11	SBUS: Output periphery address outside the periphery area
	ZINFO1: Periphery address
	ZINFO2: Slot
	ZINFO3: Data width
0xEA12	SBUS: Error in writing dataset
	ZINFO1: Slot
	ZINFO2: Dataset number
	ZINFO3: Dataset length
0xEA14	SBUS: Multiple configuration of a periphery address (diagnostic address)
	ZINFO1: Periphery address
	ZINFO2: Slot
	ZINFO3: Data width
0xEA15	Internal error - Please contact the hotline!
	ZINFO2: Slot of the master
0xEA18	SBUS: Error in mapping the master periphery
	ZINFO2: Slot of the master
0xEA19	Internal error - Please contact the hotline!

Event ID	Description
	PK: Not user relevant
	ZINFO2: HW slot
	ZINFO3: Interface type
	DatID: Not user relevant
0xEA1A	SBUS: Error in access to SBUS FPGA address table
	PK: Not user relevant
	ZINFO2: HW slot
	ZINFO3: Table
	0: Read
	1: Writing
	DatID: Not user relevant
0xEA20	Error: RS485 interface is not pre-set to PROFIBUS DP master bus a PROFIBUS DP master is configured
0xEA21	Error: Configuration RS485 interface X2/X3: PROFIBUS DP master is configured but missing
	ZINFO2: Interface X is configured incorrectly
0xEA22	Error: Configuration RS485 interface X2: Value is outside the limits
	ZINFO2: Configuration for X2
0xEA23	Error: Configuration RS485 interface X3: Value is outside the limits
	ZINFO2: Configuration for X3
0xEA24	Error: Configuration RS485 interface X2/X3: Interface/protocol missing, default settings are used
	ZINFO2: Configuration for X2
	ZINFO3: Configuration for X3
0xEA30	Internal error - Please contact the hotline!
	ZINFO1: Status
	ZINFO2: Not user relevant
	ZINFO3: Not user relevant
0xEA40	Internal error - Please contact the hotline!
	OB: Slot of the CP
	PK: File number
	ZINFO1: Version of the CP
	ZINFO2: Not user relevant
	ZINFO3: Not user relevant
	DatID: Line
0xEA41	Internal error - Please contact the hotline!
	OB: Slot of the CP
	PK: File number
	ZINFO1: Version of the CP
	ZINFO2: Not user relevant
	ZINFO3: Not user relevant

Event ID	Description
	DatID: Line
0xEA50	PROFINET IO controller: Error in the configuration OB: Not user relevant PK: Not user relevant ZINFO1: Rack/slot of the controller ZINFO2: Device number ZINFO3: Slot at the device DatID: Not user relevant
0xEA51	PROFINET IO controller: There is no PROFINET IO controller at the configured slot PK: Not user relevant ZINFO1: Rack/slot of the controller ZINFO2: Recognized type identifier at the configured slot DatID: Not user relevant
0xEA52	PROFINET IO controller: Too many configured PROFINET IO controllers PK: Not user relevant ZINFO1: Number of configured controllers ZINFO2: Slot of the excessively configured controller DatID: Not user relevant
0xEA53	PROFINET IO controller: Too many configured PROFINET IO devices ZINFO1: Number of configured devices ZINFO2: Slot ZINFO3: Maximum possible number of devices
0xEA54	PROFINET IO controller: Multiple configuration of a periphery address PK: Not user relevant ZINFO1: Logical address of the IO system ZINFO2: Rack/slot of the controller ZINFO3: Base address of the block which is too large DatID: Not user relevant
0xEA55	PROFINET IO controller: Too many slots configured ZINFO1: Rack/slot of the controller ZINFO2: Device number ZINFO3: Number of configured slots
0xEA56	PROFINET IO controller: Too many subslots configured ZINFO1: Rack/slot of the controller ZINFO2: Device number ZINFO3: Number of configured subslots
0xEA57	PROFINET IO controller: The port configuration in the virtual SLIO device has no effect.
0xEA61	Internal error - Please contact the hotline!

Event ID	Description
	OB: File number
	PK: Slot of the controller
	ZINFO1: Firmware major version
	ZINFO2: Firmware minor version
	DatID: Line
0xEA62	Internal error - Please contact the hotline!
	OB: File number.
	PK: Slot of the controller
	ZINFO1: Firmware major version
	ZINFO2: Firmware minor version
	DatID: Line
0xEA63	Internal error - Please contact the hotline!
	OB: File number
	PK: Slot of the controller
	ZINFO1: Firmware major version
	ZINFO2: Firmware minor version
	DatID: Line
0xEA64	PROFINET IO controller/EtherCAT-CP: Error in configuration
	PK: Interface
	ZINFO1 - Bit 0: Too many devices
	ZINFO1 - Bit 1: Too many devices per second
	ZINFO1 - Bit 2: Too many input bytes per millisecond
	ZINFO1 - Bit 3: Too many output bytes per millisecond
	ZINFO1 - Bit 4: Too many input bytes per device
	ZINFO1 - Bit 5: Too many output bytes per device
	ZINFO1 - Bit 6: Too many productive connections
	ZINFO1 - Bit 7: Too many input bytes in the process image
	ZINFO1 - Bit 8: Too many output bytes in the process image
	ZINFO1 - Bit 9: Configuration not available
	ZINFO1 - Bit 10: Configuration invalid
	ZINFO1 - Bit 11: Refresh interval too small
	ZINFO1 - Bit 12: Refresh interval too large
	ZINFO1 - Bit 13: Invalid device number
	ZINFO1 - Bit 14: CPU is configured as an I device
	ZINFO1 - Bit 15: Assume IP address in another way. Is not supported for the IP address of the controller.
	ZINFO2 - Bit 0: Incompatible configuration (SDB version not supported)
	ZINFO2 - Bit 1: EtherCAT: EoE configured but not supported (Possible cause is a too short cycle time of the EtherCAT master system. When using EoE terminals, at least a cycle time of 4ms must be configured.)

Event ID	Description
	ZINFO2 - Bit 2: DC parameter invalid
	ZINFO2 - Bit 3: I device configuration invalid (slot gap)
	ZINFO2 - Bit 4: MRP configuration invalid (client)
0xEA65	Internal error - Please contact the hotline!
	PK: Platform
	0: none
	8: CP
	9: Ethernet CP
	10: PROFINET CP
	12: EtherCAT CP
	16: CPU
	ZINFO1: ServiceID in which the error occurred
	ZINFO2: Command in which the error occurred
	1: Request
	2: Connect
	3: Error
0xEA66	PROFINET IO controller: Error in the communication stack
	OB: StackError.Service
	PK: Rack/slot
	ZINFO1: StackError.Error.Code
	ZINFO2: StackError.Error.Detail
	ZINFO3 - Position 0: StackError.Error.AdditionalDetail
	ZINFO3 - Position 8: StackError.Error.AreaCode
	DatID: StackError.DeviceRef
0xEA67	PROFINET IO controller: Error reading dataset
	OB: Rack/slot of the controller
	PK: Error type
	0: Dataset error local
	1: Dataset error stack
	2: Dataset error station
	ZINFO1: Dataset number
	ZINFO2: Dataset handle (caller)
	ZINFO3: Internal error code from PN stack
	DatID: Device
0xEA68	PROFINET IO controller: Error writing dataset
	OB: Rack/slot of the controller
	PK: Error type
	0: Dataset error local

Event ID	Description
	1: Dataset error stack
	2: Dataset error station
	ZINFO1: Dataset number
	ZINFO2: Dataset handle (caller)
	ZINFO3: Internal error code from PN stack
	DatID: Device
0xEA69	Internal error - Please contact the hotline!
	ZINFO1: Minimum version for the FPGA
	ZINFO2: Loaded FPGA version
0xEA6A	PROFINET IO controller: Service error in the communication stack
	OB: Service ID
	PK: Rack/slot
	ZINFO1: ServiceError.Code
	ZINFO2: ServiceError.Detail
	ZINFO3 - Position 0: ServiceError.AdditionalDetail
	ZINFO3 - Position 8: ServiceError.AreaCode
0xEA6B	PROFINET IO controller: Incorrect Vendor-ID
	OB: Operating mode
	0: Configuration in operating condition RUN
	1: STOP (update)
	2: STOP (memory reset)
	3: STOP (auto initialization)
	4: STOP (internal)
	5: STARTUP (cold start)
	6: STARTUP (restart/warm start)
	7: STARTUP (hot restart)
	9: RUN
	10: HALT
	11: COUPLING
	12: UPDATING
	13: DEFECTIVE
	14: Error search mode
	15: De-energised
	253: Process image release in STOP
	254: Watchdog
	255: Not set
	PK: Rack/slot
	ZINFO1: Device ID

Event ID	Description
	ZINFO2: Not user relevant
	ZINFO3: Not user relevant
	DatID: Not user relevant
0xEA6C	PROFINET IO controller: Incorrect Device-ID
	OB: Operating mode
	0: Configuration in operating condition RUN
	1: STOP (update)
	2: STOP (memory reset)
	3: STOP (auto initialization)
	4: STOP (internal)
	5: STARTUP (cold start)
	6: STARTUP (restart/warm start)
	7: STARTUP (hot restart)
	9: RUN
	10: HALT
	11: COUPLING
	12: UPDATING
	13: DEFECTIVE
	14: Error search mode
	15: De-energised
	253: Process image release in STOP
	254: Watchdog
	255: Not set
	PK: Rack/slot
	ZINFO1: Device ID
0xEA6D	PROFINET IO controller: No empty name
	OB: Operating mode
	0: Configuration in operating condition RUN
	1: STOP (update)
	2: STOP (memory reset)
	3: STOP (auto initialization)
	4: STOP (internal)
	5: STARTUP (cold start)
	6: STARTUP (restart/warm start)
	7: STARTUP (hot restart)
	9: RUN
	10: HALT
	11: COUPLING

Event ID	Description
	12: UPDATING
	13: DEFECTIVE
	14: Error search mode
	15: De-energised
	253: Process image release in STOP
	254: Watchdog
	255: Not set
	PK: Rack/slot
	ZINFO1: Device ID
	ZINFO2: Not user relevant
	ZINFO3: Not user relevant
	DatID: Not user relevant
0xEA6E	PROFINET IO controller: Wait for RPC response
	OB: Operating mode
	0: Configuration in operating condition RUN
	1: STOP (update)
	2: STOP (memory reset)
	3: STOP (auto initialization)
	4: STOP (internal)
	5: STARTUP (cold start)
	6: STARTUP (restart/warm start)
	7: STARTUP (hot restart)
	9: RUN
	10: HALT
	11: COUPLING
	12: UPDATING
	13: DEFECTIVE
	14: Error search mode
	15: De-energised
	253: Process image release in STOP
	254: Watchdog
	255: Not set
	PK: Rack/slot
	ZINFO1: Device ID
	ZINFO2: Not user relevant
	ZINFO3: Not user relevant
	DatID: Not user relevant
0xEA6F	PROFINET IO controller: PROFINET module deviation

Event ID	Description
	OB: Operating mode
	0: Configuration in operating condition RUN
	1: STOP (update)
	2: STOP (memory reset)
	3: STOP (auto initialization)
	4: STOP (internal)
	5: STARTUP (cold start)
	6: STARTUP (restart/warm start)
	7: STARTUP (hot restart)
	9: RUN
	10: HALT
	11: COUPLING
	12: UPDATING
	13: DEFECTIVE
	14: Error search mode
	15: De-energised
	253: Process image release in STOP
	254: Watchdog
	255: Not set
	PK: Rack/slot
	ZINFO1: Device ID
	ZINFO2: Not user relevant
	ZINFO3: Not user relevant
	DatID: Not user relevant
0xEA70	PROFINET IO controller: PROFINET stack configuration error
	OB: UnsupportedApiError.api
	PK: Rack/slot
	ZINFO1: UnsupportedApiError.slot
	ZINFO2: UnsupportedApiError.subslot
	DatID: UnsupportedApiError.deviceID
0xEA71	Internal error - Please contact the hotline!
	PK: Rack/slot
	ZINFO1: functionIndex
	ZINFO2: Not user relevant
0xEA72	Internal error - Please contact the hotline!
	OB: Connection number
	PK: Slot of the controller
	ZINFO1: Error cause

Event ID	Description
	129: PNIO
	207: RTA error
	218: AlarmAck
	219: IODConnectRes
	220: IODReleaseRes
	221: IOD/IOXControlRes
	222: IODReadRes
	223: IODWriteRes
	ZINFO2: ErrorDecode
	128: PNIORW: Service Read Write
	129: PNIO: Other Service or internal e.g. RPC errors
	130: Vendor specific
	ZINFO3: Error code (PN spec. V2.722 chapter 5.2.6)
	DatID: Device ID
0xEA81	Internal error - Please contact the hotline!
	OB: Not user relevant
	PK: Not user relevant
	ZINFO1: Filenamehash[0-3]
	ZINFO2: Filenamehash[4-7]
	ZINFO3: Line
	DatID: SvnRevision
0xEA82	Internal error - Please contact the hotline!
	OB: Not user relevant
	PK: Not user relevant
	ZINFO1: Filenamehash[0-3]
	ZINFO2: Filenamehash[4-7]
	ZINFO3: Line
	DatID: SvnRevision
0xEA83	Internal error - Please contact the hotline!
	OB: Not user relevant
	PK: Not user relevant
	ZINFO1: Filenamehash[0-3]
	ZINFO2: Filenamehash[4-7]
	ZINFO3: Line
	DatID: SvnRevision
0xEA91	Internal error - Please contact the hotline!
	OB: Current OB number
	PK: Core status

Event ID	Description
	0: INIT
	1: STOP
	2: READY
	3: PAUSE
	4: RUN
	ZINFO1: Filenamehash[0-3]
	ZINFO2: Filenamehash[4-7]
	ZINFO3: Line
	DatID: Current job number
0xEA92	Internal error - Please contact the hotline!
	OB: Current OB number
	PK: Core status
	0: INIT
	1: STOP
	2: READY
	3: PAUSE
	4: RUN
	ZINFO1: Filenamehash[0-3]
	ZINFO2: Filenamehash[4-7]
	ZINFO3: Line
	DatID: Current job number
0xEA93	Internal error - Please contact the hotline!
	OB: Current OB number
	PK: Core status
	0: INIT
	1: STOP
	2: READY
	3: PAUSE
	4: RUN
	ZINFO1: Filenamehash[0-3]
	ZINFO2: Filenamehash[4-7]
	ZINFO3: Line
	DatID: Current job number
0xEA97	Internal error - Please contact the hotline!
	ZINFO3: Slot
0xEA98	Error in file reading via SBUS
	PK: Not user relevant
	ZINFO3: Slot

Event ID	Description
	DatID: Not user relevant
0xEA99	Parameter assignment job could not be executed
	PK: Not user relevant
	ZINFO1: File version on MMC/SD (if not 0)
	ZINFO2: File version of the SBUS module (if not 0)
	ZINFO3: Slot
	DatID: Not user relevant
0xEAA0	Internal error - Please contact the hotline!
	OB: Current operating mode
	0: Configuration in operating condition RUN
	1: STOP (update)
	2: STOP (memory reset)
	3: STOP (auto initialization)
	4: STOP (internal)
	5: STARTUP (cold start)
	6: STARTUP (restart/warm start)
	7: STARTUP (hot restart)
	9: RUN
	10: HALT
	11: COUPLING
	12: UPDATING
	13: DEFECTIVE
	14: Error search mode
	15: De-energised
	253: Process image release in STOP
	254: Watchdog
	255: Not set
	ZINFO1: Diagnostic address of the master
	ZINFO2: Not user relevant
	ZINFO3: Number of errors which occurred
0xEAB0	Invalid link mode
	OB: Current operating mode
	0: Configuration in operating condition RUN
	1: STOP (update)
	2: STOP (memory reset)
	3: STOP (auto initialization)
	4: STOP (internal)
	5: STARTUP (cold start)

Event ID	Description
	6: STARTUP (restart/warm start)
	7: STARTUP (hot restart)
	9: RUN
	10: HALT
	11: COUPLING
	12: UPDATING
	13: DEFECTIVE
	14: Error search mode
	15: De-energised
	253: Process image release in STOP
	254: Watchdog
	255: Not set
	ZINFO1: Diagnostic address of the master
	ZINFO2: Current connection mode
	1: 10Mbit half-duplex
	2: 10Mbit full-duplex
	3: 100Mbit half-duplex
	4: 100Mbit full-duplex
	5: Connection mode undefined
	6: Auto Negotiation
0xEAC0	Internal error - Please contact the hotline!
	ZINFO1: Error code
	2: Internal error
	3: Internal error
	4: Internal error
	5: Internal error
	6: Internal error
	7: Internal error
	8: Internal error
	8: Internal error
0xEAD0	SyncUnit configuration error
	ZINFO1: Status
0xEB02	System SLIO error: Preset configuration does not match actual configuration
	ZINFO1: Bit mask slots 1-16
	ZINFO2: Bit mask slots 17-32
	ZINFO3: Bit mask slots 33-48
	DatID: Bit mask slots 49-64
0xEB03	System SLIO error: IO mapping

Event ID	Description
	PK: Not user relevant
	ZINFO1: Error type
	1: SDB parser error
	2: Configured address already used
	3: Mapping error
	ZINFO2: Slot (0=cannot be determined)
	DatID: Not user relevant
0xEB04	SLIO-Bus: Multiple configuration of a periphery address
	ZINFO1: Periphery address
	ZINFO2: Slot
	DatID: Input
	DatID: Output
0xEB05	System SLIO error: Bus structure for isochronous process image not suitable
	PK: Not user relevant
	ZINFO2: Slot (0=cannot be determined)
	DatID: Not user relevant
0xEB06	System SLIO error: Timeout with the isochronous process image
0xEB10	System SLIO error: Bus error
	PK: Not user relevant
	ZINFO1: Error type
	96: Bus enumeration error
	128: General error
	129: Queue execution error
	130: Error interrupt
	ZINFO2: Error on bus enumeration error (ZINFO1)
	DatID: Not user relevant
0xEB11	System SLIO error: Error during bus initialization
	PK: Not user relevant
	DatID: Not user relevant
0xEB20	System SLIO error: Interrupt information undefined
0xEB21	System SLIO error: Accessing configuration data
	ZINFO2: Not user relevant
	ZINFO3: Not user relevant
	DatID: Not user relevant
0xEC02	EtherCAT: configuration warning
	ZINFO1: Error code
	1: Number of slave stations is not supported
	2: Master system ID invalid

Event ID	Description
	3: Slot invalid
	4: Master configuration invalid
	5: Master type invalid
	6: Slave diagnostic address invalid
	7: Slave address invalid
	8: Slave module IO configuration invalid
	9: Logical address already in use
	10: Internal error
	11: IO mapping error
	12: Error
	13: Error in initialising the EtherCAT stack (is entered by the CP)
	14: Slave station number already occupied by virtual SLIO device
	ZINFO2: Station number
	0xEC03
PK: Not user relevant	
ZINFO1: Error code	
1: Number of slave stations is not supported	
2: Master system ID invalid	
3: Slot invalid	
4: Master configuration invalid	
5: Master type invalid	
6: Slave diagnostic address invalid	
7: Slave address invalid	
8: Slave module IO configuration invalid	
9: Logical address already in use	
10: Internal error	
11: IO mapping error	
12: Error	
13: Error in initialising the EtherCAT stack (is entered by the CP)	
14: Slave station number already occupied by virtual SLIO device	
ZINFO2: Station number	
ZINFO3: Not user relevant	
DatID: Not user relevant	
0xEC04	EtherCAT: Multiple configuration of a periphery address
	PK: Not user relevant
	ZINFO1: Periphery address
	ZINFO2: Slot
	DatID: Not user relevant

Event ID	Description
0xEC05	EtherCAT: Check the set DC mode of the YASKAWA Sigma 5/7 drive
	OB: Operating mode
	0: Configuration in operating condition RUN
	1: STOP (update)
	2: STOP (memory reset)
	3: STOP (auto initialization)
	4: STOP (internal)
	5: STARTUP (cold start)
	6: STARTUP (restart/warm start)
	7: STARTUP (hot restart)
	9: RUN
	10: HALT
	11: COUPLING
	12: UPDATING
	13: DEFECTIVE
	14: Error search mode
	15: De-energised
	253: Process image release in STOP
	254: Watchdog
	255: Not set
	PK: Not user relevant
	ZINFO1: Station address of the EtherCAT device
	ZINFO2: Error code
	1: WARNING: For the drive the DC Beckhoff mode is recommended (DC reference clock is not in Beckhoff Mode)!
	2: NOTE: For the drive the DC Hilscher mode is recommended (DC reference clock is not in Beckhoff Mode)!
	3: The station address could not be determined for checking (station address in ZINFO1 is accordingly 0)
	4: The slave information could not be determined for checking (station address in ZINFO1 is accordingly 0)
	5: The EtherCAT status of the drive could not be determined
	6: Error when sending the SDO request (for further information, the (subsequent) event with the ID 0xED60 is to be analysed on the CP)
	7: Drive returns error in the SDO response (for further information, the (subsequent) event with the ID 0xED60 is to be analysed on the CP)
8: SDO time out, DC mode could not be determined (for further information, the (subsequent) event with the ID 0xED60 is to be analysed on the CP)	
ZINFO3: Not user relevant	
DatID: Not user relevant	
0xEC10	EtherCAT: Recurrence bus with all slaves
	ZINFO1 - Position 0: New status

Event ID	Description
	0: Undefined/Unkown
	1: Init
	2: PreOp
	3: Bootstrap
	4: SafeOp
	8: Op
	ZINFO1 - Position 8: Previous status
	0: Undefined/Unkown
	1: Init
	2: PreOp
	3: Bootstrap
	4: SafeOp
	8: Op
	ZINFO2: Diagnostic address of the station
	ZINFO3: Number of stations, which are not in the same state as the master
	DatID: Station not available
	DatID: Station available
	DatID: Input address
	DatID: Output address
	0xEC11
ZINFO1 - Position 0: New status	
0: Undefined/Unkown	
1: Init	
2: PreOp	
3: Bootstrap	
4: SafeOp	
8: Op	
ZINFO1 - Position 8: Previous status	
0: Undefined/Unkown	
1: Init	
2: PreOp	
3: Bootstrap	
4: SafeOp	
8: Op	
ZINFO2: Diagnostic address of the master	
ZINFO3: Number of stations which are not in the same state as the master	
DatID: Station not available	
DatID: Station available	

Event ID	Description
	DatID: Input address
	DatID: Output address
0xEC12	EtherCAT: Recurrence slave
	ZINFO1 - Position 0: New status
	0: Undefined/Unkown
	1: Init
	2: PreOp
	3: Bootstrap
	4: SafeOp
	8: Op
	ZINFO1 - Position 8: Previous status
	0: Undefined/Unkown
	1: Init
	2: PreOp
	3: Bootstrap
	4: SafeOp
	8: Op
	ZINFO2: Diagnostic address of the station
	ZINFO3: AL status code
	DatID: Station not available
	DatID: Station available
	DatID: Input address
	DatID: Output address
0xEC30	EtherCAT: Topology OK
	ZINFO2: Diagnostic address of the master
0xEC40	Bus cycle time infringement resolved
	ZINFO2: Logical address of the IO system
0xEC50	EtherCAT: Distributed clocks (DC) out of sync
	OB: Operating mode
	0: Configuration in operating condition RUN
	1: STOP (update)
	2: STOP (memory reset)
	3: STOP (auto initialization)
	4: STOP (internal)
	5: STARTUP (cold start)
	6: STARTUP (restart/warm start)
	7: STARTUP (hot restart)
	9: RUN

Event ID	Description
	10: HALT
	11: COUPLING
	12: UPDATING
	13: DEFECTIVE
	14: Error search mode
	15: De-energised
	253: Process image release in STOP
	254: Watchdog
	255: Not set
	ZINFO2: Diagnostic address of the master
	ZINFO3: DC state change
	0: DC master out of sync
	1: DC slave stations out of sync
0xEC80	EtherCAT: Bus error resolved
	ZINFO1: Logical address of the IO system
	ZINFO3 - Position 0: Station number
	ZINFO3 - Position 11: IO system ID
	ZINFO3 - Bit 15: System ID DP/PN
0xED10	EtherCAT: Breakdown bus
	ZINFO1 - Position 0: New status
	0: Undefined/Unkown
	1: Init
	2: PreOp
	3: Bootstrap
	4: SafeOp
	8: Op
	ZINFO1 - Position 8: Previous status
	0: Undefined/Unkown
	1: Init
	2: PreOp
	3: Bootstrap
	4: SafeOp
	8: Op
	ZINFO2: Diagnostic address of the master
	ZINFO3: Number of stations which are not in the same state as the master
	DatID: Station available
	DatID: Station not available
	DatID: Input address

Event ID	Description
	DatID: Output address
0xED12	EtherCAT: Breakdown slave
	ZINFO1 - Position 0: New status
	0: Undefined/Unkown
	1: Init
	2: PreOp
	3: Bootstrap
	4: SafeOp
	8: Op
	ZINFO1 - Position 8: Previous status
	0: Undefined/Unkown
	1: Init
	2: PreOp
	3: Bootstrap
	4: SafeOp
	8: Op
	ZINFO2: Diagnostic address of the station
	ZINFO3: AIStatusCode
	0: No error
	1: Unspecified error
	17: Invalid requested status change
	18: Unknown requested status
	19: Bootstrap not supported
	20: No valid firmware
	22: Invalid mailbox configuration
	22: Invalid mailbox configuration
	23: Invalid sync manager configuration
	24: No valid inputs available
	25: No valid outputs available
	26: Synchronisation error
	27: Sync manager watchdog
	28: Invalid sync manager types
	29: Invalid output configuration
	30: Invalid input configuration
	31: Invalid watchdog configuration
32: Slave station needs cold start	
33: Slave station needs to be in INIT state	
34: Slave station needs to be in PreOp state	

Event ID	Description
	35: Slave station needs to be in SafeOp state
	45: Invalid output FMMU configuration
	46: Invalid input FMMU configuration
	48: Invalid DC Sync configuration
	49: Invalid DC Latch configuration
	50: PLL error
	51: Invalid DC IO error
	52: Invalid DC time out error
	66: Error in acyclic data exchange Ethernet Over EtherCAT
	67: Error in acyclic data exchange CAN Over EtherCAT
	68: Error in acyclic data exchange Fileaccess Over EtherCAT
	69: Error in acyclic data exchange Servo Drive Profile Over EtherCAT
	79: Error in acyclic data exchange Vendorspecific Over EtherCAT
	DatID: Station not available
	DatID: Station available
	DatID: Input address
	DatID: Output address
0xED20	EtherCAT: Bus state change without calling OB86
	ZINFO1 - Position 0: New status
	0: Undefined/Unkown
	1: Init
	2: PreOp
	3: Bootstrap
	4: SafeOp
	8: Op
	ZINFO1 - Position 8: Previous status
	0: Undefined/Unkown
	1: Init
	2: PreOp
	3: Bootstrap
	4: SafeOp
	8: Op
	ZINFO2: Diagnostic address of the master
	ZINFO3: Number of stations which are not in the same state as the master
	DatID: Station not available
	DatID: Station available
	DatID: Input address
	DatID: Output address

Event ID	Description
0xED21	EtherCAT: Incorrect bus status change
	ZINFO1 - Position 0: New status
	0: Undefined/Unkown
	1: Init
	2: PreOp
	3: Bootstrap
	4: SafeOp
	8: Op
	ZINFO1 - Position 8: Previous status
	0: Undefined/Unkown
	1: Init
	2: PreOp
	3: Bootstrap
	4: SafeOp
	8: Op
	ZINFO2: Diagnostic address of the master
	ZINFO3: Error code
	4: Cancel (master state change)
	8: Busy
	11: Invalid parameters
	14: Invalid status
	16: Time out
	DatID: Station available
	DatID: Station not available
	DatID: Output address
	DatID: Input address
0xED22	EtherCAT: Slave status change that does not generate an OB86
	ZINFO1 - Position 0: New status
	0: Undefined/Unkown
	1: Init
	2: PreOp
	3: Bootstrap
	4: SafeOp
	8: Op
	ZINFO1 - Position 8: Previous status
	0: Undefined/Unkown
	1: Init
2: PreOp	

Event ID	Description
	3: Bootstrap
	4: SafeOp
	8: Op
	ZINFO2: Diagnostic address of the station
	ZINFO3: AIStatusCode
	0: No error
	1: Unspecified error
	17: Invalid requested status change
	18: Unknown requested status
	19: Bootstrap not supported
	20: No valid firmware
	22: Invalid mailbox configuration
	22: Invalid mailbox configuration
	23: Invalid sync manager configuration
	24: No valid inputs available
	25: No valid outputs available
	26: Synchronisation error
	27: Sync manager watchdog
	28: Invalid sync manager types
	29: Invalid output configuration
	30: Invalid input configuration
	31: Invalid watchdog configuration
	32: Slave station needs cold start
	33: Slave station needs to be in INIT state
	34: Slave station needs to be in PreOp state
	35: Slave station needs to be in SafeOp state
	45: Invalid output FMMU configuration
	46: Invalid input FMMU configuration
	48: Invalid DC Sync configuration
	49: Invalid DC Latch configuration
	50: PLL error
	51: Invalid DC IO error
	52: Invalid DC time out error
	66: Error in acyclic data exchange Ethernet Over EtherCAT
	67: Error in acyclic data exchange CAN Over EtherCAT
	68: Error in acyclic data exchange Fileaccess Over EtherCAT
	69: Error in acyclic data exchange Servo Drive Profile Over EtherCAT
	79: Error in acyclic data exchange Vendorspecific Over EtherCAT

Event ID	Description
	DatID: Station not available
	DatID: Station available
	DatID: Input address
	DatID: Output address
0xED23	EtherCAT: Time out while changing the master state to OP, after CPU has changed to RUN
	OB: Operating mode
	0: Configuration in operating condition RUN
	1: STOP (update)
	2: STOP (memory reset)
	3: STOP (auto initialization)
	4: STOP (internal)
	5: STARTUP (cold start)
	6: STARTUP (restart/warm start)
	7: STARTUP (hot restart)
	9: RUN
	10: HALT
	11: COUPLING
	12: UPDATING
	13: DEFECTIVE
	14: Error search mode
	15: De-energised
	253: Process image release in STOP
	254: Watchdog
	255: Not set
	ZINFO1: Master status
	0: Undefined/Unkown
	1: Init
	2: PreOp
	3: Bootstrap
	4: SafeOp
	8: Op
	ZINFO2: EtherCAT configuration present
	0: There is no EC configuration
	1: There is an EC configuration
	ZINFO3: DC in sync
	0: Not in sync
	1: In sync
0xED30	EtherCAT: Topology deviation

Event ID	Description
	ZINFO2: Diagnostic address of the master
0xED31	EtherCAT: Overflow of the interrupt queue
	ZINFO2: Diagnostic address of the master
0xED40	Bus cycle time infringement occurred
	ZINFO1: Logical address of the IO system
0xED50	EtherCAT: Distributed clocks (DC) in sync
	OB: Operating mode
	0: Configuration in operating condition RUN
	1: STOP (update)
	2: STOP (memory reset)
	3: STOP (auto initialization)
	4: STOP (internal)
	5: STARTUP (cold start)
	6: STARTUP (restart/warm start)
	7: STARTUP (hot restart)
	9: RUN
	10: HALT
	11: COUPLING
	12: UPDATING
	13: DEFECTIVE
	14: Error search mode
	15: De-energised
	253: Process image release in STOP
	254: Watchdog
	255: Not set
	ZINFO2: Diagnostic address of the master
	ZINFO3: DC state change
	0: Master
	1: Slave
0xED60	EtherCAT: Diagnostic buffer CP: Slave status change
	OB: Operating mode
	0: Configuration in operating condition RUN
	1: STOP (update)
	2: STOP (memory reset)
	3: STOP (auto initialization)
	4: STOP (internal)
	5: STARTUP (cold start)
	6: STARTUP (restart/warm start)

Event ID	Description
	7: STARTUP (hot restart)
	9: RUN
	10: HALT
	11: COUPLING
	12: UPDATING
	13: DEFECTIVE
	14: Error search mode
	15: De-energised
	253: Process image release in STOP
	254: Watchdog
	255: Not set
	ZINFO1 - Position 0: New status
	0: Undefined/Unkown
	1: Init
	2: PreOp
	3: Bootstrap
	4: SafeOp
	8: Op
	ZINFO2: Slave address
	ZINFO3: AIstatusCode
	0: No error
	1: Unspecified error
	17: Invalid requested status change
	18: Unknown requested status
	19: Bootstrap not supported
	20: No valid firmware
	22: Invalid mailbox configuration
	22: Invalid mailbox configuration
	23: Invalid sync manager configuration
	24: No valid inputs available
	25: No valid outputs available
	26: Synchronisation error
	27: Sync manager watchdog
	28: Invalid sync manager types
	29: Invalid output configuration
	30: Invalid input configuration
	31: Invalid watchdog configuration
	32: Slave station needs cold start

Event ID	Description
	33: Slave station needs to be in INIT state
	34: Slave station needs to be in PreOp state
	35: Slave station needs to be in SafeOp state
	45: Invalid output FMMU configuration
	46: Invalid input FMMU configuration
	48: Invalid DC Sync configuration
	49: Invalid DC Latch configuration
	50: PLL error
	51: Invalid DC IO error
	52: Invalid DC time out error
	66: Error in acyclic data exchange Ethernet Over EtherCAT
	67: Error in acyclic data exchange CAN Over EtherCAT
	68: Error in acyclic data exchange Fileaccess Over EtherCAT
	69: Error in acyclic data exchange Servo Drive Profile Over EtherCAT
	79: Error in acyclic data exchange Vendorspecific Over EtherCAT
	DatID: Cause for slave status change
	0: Regular slave status change
	1: Slave failure
	2: Recurrence slave
	3: Slave is in an error state
	4: Slave has unexpectedly changed its status
0xED61	EtherCAT: Diagnostic buffer CP: CoE emergency
	OB: EtherCAT station address (high byte)
	PK: EtherCAT station address (low byte)
	ZINFO1 - Position 0: Error register
	ZINFO1 - Position 8: MEF-Byte1
	ZINFO2 - Position 0: MEF-Byte2
	ZINFO2 - Position 8: MEF-Byte3
	ZINFO3 - Position 0: MEF-Byte4
	ZINFO3 - Position 8: MEF-Byte5
	DatID: Error code
0xED62	EtherCAT: Diagnostic buffer CP: Error on SDO access
	OB: EtherCAT station address (high byte)
	PK: EtherCAT station address (low byte)
	ZINFO1: Index
	ZINFO2: SDO error code (high word)
	ZINFO3: SDO error code (low word)
	DatID: Sub index

Event ID	Description
0xED63	EtherCAT: Diagnostic buffer CP: Error in the response to an INIT command
	OB: EtherCAT station address (high byte)
	PK: EtherCAT station address (low byte)
	ZINFO1: Error type
	0: Not defined
	1: No response
	2: Validation error
	3: INIT command failed, requested station could not be reached
0xED70	EtherCAT: Diagnostic buffer CP: Twofold hot connect group recognised
	OB: Operating mode
	0: Configuration in operating condition RUN
	1: STOP (update)
	2: STOP (memory reset)
	3: STOP (auto initialization)
	4: STOP (internal)
	5: STARTUP (cold start)
	6: STARTUP (restart/warm start)
	7: STARTUP (hot restart)
	9: RUN
	10: HALT
	11: COUPLING
	12: UPDATING
	13: DEFECTIVE
	14: Error search mode
	15: De-energised
	253: Process image release in STOP
	254: Watchdog
	255: Not set
ZINFO1: Diagnostic address of the master	
ZINFO2: EtherCAT station address	
0xED80	Bus error occurred (receive time-out)
	ZINFO1: Logical address of the IO system
	ZINFO3 - Position 0: Station number
	ZINFO3 - Position 11: IO system ID
	ZINFO3 - Bit 15: System ID DP/PN
0xEE00	Additional information at UNDEF_OPCODE
	OB: Not user relevant
	ZINFO1: Not user relevant

Event ID	Description
	ZINFO2: Not user relevant
	ZINFO3: Not user relevant
	DatID: Not user relevant
0xEE01	Internal error - Please contact the hotline!
	ZINFO3: SFB number
0xEEEE	CPU was completely deleted, since after PowerON the start-up could not be finished
0xEF00	Internal error - Please contact the hotline!
	DatID: Not user relevant
0xEF01	Internal error - Please contact the hotline!
	ZINFO1: Not user relevant
	ZINFO2: Not user relevant
	ZINFO3: Not user relevant
	DatID: Not user relevant
0xEF11	Internal error - Please contact the hotline!
0xEF12	Internal error - Please contact the hotline!
0xEF13	Internal error - Please contact the hotline!
0xEFFE	Internal error - Please contact the hotline!
	PK: Not user relevant
	ZINFO3: Not user relevant
	DatID: Not user relevant
0xEFFF	Internal error - Please contact the hotline!
	PK: Not user relevant
	ZINFO3: Not user relevant
	DatID: Not user relevant
0xF9C1	Restart of the component
	OB: NCM_EVENT
	1: OVS: Component start-up request was denied
	3: Component data basis invalid
	6: IP_CONFIG: New IP address assigned by STEP7 configuration
	10: IP_CONFIG: A non-configured new IP address was assigned
	13: HW reset at P bus (for CPU memory reset)
	19: Switch actuation from STOP to RUN causes the restart of the component
	20: MGT: PG command causes the restart of the component
	21: MGT: Take-over of component data basis causes the hot restart of the component
	23: Stopping the sub-system after having loaded the already existing consistency-secured SDBs xxxx by the rack component
	25: The SIMATIC procedure has been selected for the time synchronisation of the component.
	26: Component actively established a connection
	28: The SDB xxxx loaded by the rack component is the consistency securing object (SDB type 0x3118)

Event ID	Description
	29: The component actively disconnected the system connection to the CPU
	31: Inconsistency of the component data base by loading SDB xxxx by the rack component (SDB type 0x3100)
	32: Periphery enabled by S7-CPU
	33: Periphery disabled by S7-CPU
	34: Component STOP due to switch actuation
	35: Component STOP due to invalid configuration
	36: Component STOP due to PG command
	38: SDB xxxx is not registered in the still valid consistency securing object, or it has an incorrect time stamp (SDB type 0x3107), the error is being corrected
	40: Memory reset executed
	44: Consistency of the data base achieved after loading the SDBs xxxx by the rack component (SDB type xxxx)
	45: Remanent part of the component data base is deleted by the rack component after being loaded
	70: Restore factory defaults (same as memory reset of CPU!)
	83: Network interface: automatic configuration, TP/ITP with 10 Mbit/s semi-duplex
	96: The MAC address was retrieved from the system SDB. This is the configured address.
	97: The MAC address was retrieved from the boot EPROM. This is the factory-provided address.
	100: Restart of the component
	101: Component STOP due to deletion of system SDBs
	104: PG command start was denied due to missing or inconsistent configuration
	105: Component STOP due to double IP address
	107: Start-up request by switch actuation was denied due to missing or inconsistent configuration
	PK: NCM_SERVICE
	2: Management
	3: Object management system
	6: Time synchronisation
	10: IP_CONFIG
	38: SEND/RECEIVE

B Integrated blocks

OB	Name	Description
OB 1	CYCL_EXC	Program Cycle
OB 10	TOD_INT0	Time-of-day Interrupt
OB 20	DEL_INT0	Time delay interrupt
OB 21	DEL_INT1	Time delay interrupt
OB 32	CYC_INT2	Cyclic interrupt
OB 33	CYC_INT3	Cyclic interrupt
OB 34	CYC_INT4	Cyclic interrupt
OB 35	CYC_INT5	Cyclic interrupt
OB 40	HW_INT0	Hardware interrupt
OB 80	CYCL_FLT	Time error
OB 81	PS_FLT	Power supply error
OB 82	I/O_FLT1	Diagnostics interrupt
OB 83	I/O_FLT2	Insert / remove module
OB 85	OBNL_FLT	Priority class error
OB 86	RACK_FLT	Slave failure / restart
OB 100	COMPLETE RESTART	Start-up
OB 102	COLD RESTART	Start-up
OB 121	PROG_ERR	Programming error
OB 122	MOD_ERR	Periphery access error

SFB	Name	Description
SFB 0	CTU	Up-counter
SFB 1	CTD	Down-counter
SFB 2	CTUD	Up-down counter
SFB 3	TP	Create pulse
SFB 4	TON	On-delay
SFB 5	TOF	Create turn-off delay
SFB 7	TIMEMESS	Time measurement
SFB 12	BSEND	Sending data in blocks
SFB 13	BRCV	Receiving data in blocks:
SFB 14	GET	Remote CPU read
SFB 15	PUT	Remote CPU write
SFB 32	DRUM	Realize a step-by-step switch
SFB 47	COUNT	Control counter
SFB 48	FREQUENC	Frequency measurement

SFB	Name	Description
SFB 49	PULSE	Pulse width modulation
SFB 52	RDREC	Read record set
SFB 53	WRREC	Write record set
SFB 54	RALRM	Receiving an interrupt from a periphery module

SFC	Name	Description
SFC 0	SET_CLK	Set system clock
SFC 1	READ_CLK	Read system clock
SFC 2	SET_RTM	Set run-time meter
SFC 3	CTRL_RTM	Control run-time meter
SFC 4	READ_RTM	Read run-time meter
SFC 5	GADR_LGC	Logical address of a channel
SFC 6	RD_SINFO	Read start information
SFC 7	DP_PRAL	Triggering a hardware interrupt on the DP master
SFC 12	D_ACT_DP	Activating and deactivating of DP slaves
SFC 13	DPNRM_DG	Read diagnostic data of a DP slave
SFC 14	DPRD_DAT	Read consistent data
SFC 15	DPWR_DAT	Write consistent data
SFC 17	ALARM_SQ	ALARM_SQ
SFC 18	ALARM_SQ	ALARM_S
SFC 19	ALARM_SC	Acknowledgement state last alarm
SFC 20	BLKMOV	Block move
SFC 21	FILL	Fill a field
SFC 22	CREAT_DB	Create a data block
SFC 23	DEL_DB	Deleting a data block
SFC 24	TEST_DB	Test data block
SFC 28	SET_TINT	Set time-of-day interrupt
SFC 29	CAN_TINT	Cancel time-of-day interrupt
SFC 30	ACT_TINT	Activate time-of-day interrupt
SFC 31	QRY_TINT	Query time-of-day interrupt
SFC 32	SRT_DINT	Start time-delay interrupt
SFC 33	CAN_DINT	Cancel time-delay interrupt
SFC 34	QRY_DINT	Query time-delay interrupt
SFC 36	MSK_FLT	Mask synchronous errors
SFC 37	MSK_FLT	Unmask synchronous errors
SFC 38	READ_ERR	Read error register
SFC 39	DIS_IRT	Disabling interrupts

SFC	Name	Description
SFC 40	EN_IRT	Enabling interrupts
SFC 41	DIS_AIRT	Delaying interrupts
SFC 42	EN_AIRT	Enabling delayed interrupts
SFC 43	RE_TRIGR	Re-trigger the watchdog
SFC 44	REPL_VAL	Replace value to ACCU1
SFC 46	STP	STOP the CPU
SFC 47	WAIT	Delay the application program
SFC 49	LGC_GADR	Read the slot address
SFC 51	RDSYSST	Read system status list SSL
SFC 52	WR_USMSG	Write user entry into diagnostic buffer
SFC 53	μS_TICK	Time measurement
SFC 54	RD_DPARM	Reading predefined parameters
SFC 55	WR_PARM	Write dynamic parameter
SFC 56	WR_DPARM	Write default parameter
SFC 57	PARM_MOD	Parametrize module
SFC 58	WR_REC	Write record set
SFC 59	RD_REC	Read record set
SFC 64	TIME_TCK	Read system time tick
SFC 65	X_SEND	Sending data
SFC 66	X_RCV	Receiving data
SFC 67	X_GET	Read data
SFC 68	X_PUT	Write data
SFC 69	X_ABORT	Disconnect
SFC 70	GEO_LOG	Determining the start address of a module
SFC 71	LOG_GEO	Determining the slot belonging to a logical address
SFC 81	UBLKMOV	Copy data area without gaps
SFC 101	HTL_RTM	Handling runtime meters
SFC 102	RD_DPARA	Reading predefined parameters
SFC 105	READ_SI	Reading dynamic system resources
SFC 106	DEL_SI	Releasing dynamic system resources
SFC 107	ALARM_DQ	ALARM_DQ
SFC 108	ALARM_DQ	ALARM_DQ

C SSL partial list



More information about this may be found in the manual "SPEED7 Operation List" from VIPA.

SSL-ID	SSL partial list
xy11h	Module identification
xy12h	CPU characteristics
xy13h	User memory areas
xy14h	System areas
xy15h	Block Types
xy19h	Status of all LEDs
xy1Ch	Identification of the component
xy22h	Interrupt status
xy32h	Communication status data
xy37h	Ethernet details of the module
xy3Ah	Status of the TCON Connections
xy3Eh	Web server diagnostic information
xy74h	Status of the LEDs
xy91h	Status information CPU
xy92h	Stations status information (DPM)
xy94h	Stations status information (DPM, PROFINET-IO and EtherCAT)
xy96h	Module status information (PROFIBUS DP, PROFINET-IO, EtherCAT)
xyA0h	Diagnostic buffer of the CPU
xyB3h	Module diagnostic information (record set 1) via logical address
xyB4h	Diagnostic data of a DP slave
xyE0h	Information EtherCAT master/slave
xyE1h	EtherCAT bus system
xyFAh	Statistics information to OBs
xyFCh	Status of the VSC features from the CPU